

# Solutions

STORAGE SYSTEMS AND KITCHEN ACCESSORIES



*Combining innovation and functionality*

**Richelieu**  
richelieu.com

# *A universe of solutions*



## **Innovative solutions that transform the kitchen into a functional and comfortable space.**

### **Enhanced efficiency**

The careful planning of the kitchen by activity zones will reduce the time spent traveling between each space, and thus increasing productivity.

### **Ergonomics- Improved comfort**

Functional accessories enhance comfort by improving user postures and movements, while also reducing effort. Our storage systems prioritize ergonomics, promoting fluid movement and efficiency in the workspace.

### **Maximum visibility**

With sliding systems, all items are easily visible at once, simplifying access to stored products.

### **Full accessibility**

Our storage systems boast sophisticated mechanisms that ensure full access to every corner of the kitchen.

FOOD STORAGE



STORAGE



PLAN,

STORE AND

COOK.



**Food storage zone**

Using a vertical pantry ensures that all products are visible at a glance and readily accessible.



**Storage zone**

Cutlery and utensil dividers present a range of layout choices to maximize organization within drawers.

*Revamp the kitchen with clever space organization solutions.*

*The kitchen, as a functional space, requires efficient organization to facilitate meal preparation, cooking, and cleaning. Each activity area necessitates specific accessories to optimize functionality.*

**CLEANING****Cleaning zone**

Improve the functionality of the washing area next to the under-sink cabinet by integrating waste and recycling bins for effective waste management, which includes selective sorting and composting. Also, make use of storage options for cleaning products and incorporate sliding towel rails for enhanced convenience.

**PREPARATION****Preparation zone**











Sliding baskets ensure that all meal preparation accessories and utensils are easily accessible.

**COOKING****Cooking zone**

Incorporating suitable accessories in the cooking area simplifies meal preparation and upkeep, including storage for frying pans and saucepans, a spice rack, and more.

*An efficiently organized kitchen not only saves time during meal preparation but also creates a pleasant working atmosphere. The comfort and functionality of the kitchen are directly influenced by the level of accessorization within each of its five activity zones.*

## TABLE OF CONTENTS

	PANTRY AND FULL-HEIGHT CABINETS > 2
	DRAWERS AND DIVIDERS > 22
	BASE CABINETS > 42
	UNDER-SINK CABINETS > 56
	UPPER CABINETS > 62
	WASTE BINS AND RECYCLING CENTERS > 72
	CORNER CABINETS > 96
	COUNTERTOPS AND ACCESSORIES > 114
	PULL-OUT TABLE MECHANISMS AND COUNTERTOP EXTENSIONS > 122
	BATHROOM AND LAUNDRY ROOM > 130



Convoy Centro and  
Convoy Lavido

## *Must-have essentials for ergonomic kitchen*

Pull-out pantries are a game changer in the kitchen, with optimized, centralized storage space. Enjoy easy access, enhanced efficiency, and style for effortless everyday tasks.



*Convoy Centro*

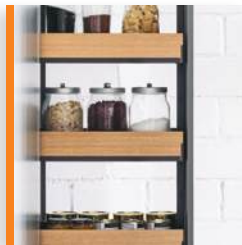

*Dispensa Fiore*

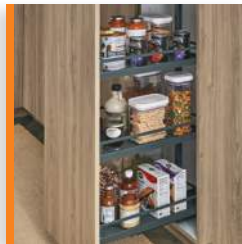

*Dispensa Anthracite*



*Tandem Depot*

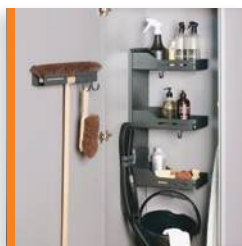

*Sesam*

<i>Convoy Lavido system</i>	4
<i>Convoy Centro system</i>	6
<i>Dispensa Fiore system</i>	8
<i>Pleno Fiore system</i>	10
<i>Extendo Fiore and Clickstop shelves</i>	11
<i>Dispensa system</i>	12
<i>Dispensa Anthracite system</i>	14
<i>Tandem Depot system</i>	15
<i>Dispensa U.S. system</i>	16
<i>Hinged door system</i>	18
<i>Step-fix and Stepolo step stools</i>	19
<i>Sesam storage system</i>	20



FOOD STORAGE STORAGE

PANTRY AND FULL-HEIGHT CABINETS

CONVOY LAVIDO SLIDING SHELF SYSTEM

# Smart ways to use space

Where there's cooking, there's food. The *Convoy Lavido* system is the ultimate sliding storage solution for dry goods, preserves and other containers.



- + *Convoy Lavido* products are the ideal solution for cabinets with hinged doors.
- + Each unit consists of a frame, a runner and shelves (four or five depending on available interior height).
- + Shelves are accessible from three sides.
- + Easy, customizable vertical shelf adjustment.
- + The *Convoy Lavido* has a load capacity of 270 lb (120 kg).
- + Integrated soft-close mechanism
- + Power-assisted opening and closing, made possible by the performance of our synchronized sliding mechanism – a world first!
- + Non-slip melamine shelf (CARB-certified) with elegant glass and chrome contours.



Works with 110D series hinges, but 155-165D hinges are recommended for better access.

**Caution: the height of the shelves must be adjusted to avoid interference with the hinges.**







## EASY TO ORDER

1

Order a frame according to suggested height.

2

Order a runner.

3

Order a set of four shelves.

4

Add one or more shelves according to the suggested height.

The *Convoy Lavidó* system package must comprise a set of four shelves, which includes the essential top shelf (C) necessary for assembly.

Additional individual shelves (D) can only be included as supplementary components when a system with more than four shelves is needed.

Please note that these individual shelves cannot serve as top shelves for assembly. The suggested installation height accommodates approximately 12" (304 mm) of space for storing containers on the top shelf.

### 1 Frame

Fig.	Code	Description	Int. height required	Number of shelves recommended
A	23650100	<i>Convoy Lavidó</i> frame	59" to 63" (1,500 to 1,600 mm)	4
A	23660100	<i>Convoy Lavidó</i> frame	63" to 66 7/8" (1,600 to 1,700 mm)	4
A	23670100	<i>Convoy Lavidó</i> frame	66 7/8" to 70 7/8" (1,700 to 1,800 mm)	5
A	23690100	<i>Convoy Lavidó</i> frame	74 3/4" to 78 3/4" (1,900 to 2,000 mm)	5-6

### 2 System runner

Fig.	Code	Description
B	23730100	<i>Convoy Lavidó</i> system runner

### 3 Set of 4 shelves (required)

Fig.	Code	Description	Shelf width	Min. int. width required
C	2531140150	Set of 4 shelves, maple/chrome	15 3/4" (400 mm)	16 1/4" (412 mm)
C	2533140150	Set of 4 shelves, maple/chrome	17 3/4" (450 mm)	18 1/4" (462 mm)
C	2534140150	Set of 4 shelves, maple/chrome	21 5/8" (550 mm)	22 1/8" (562 mm)
C	2531140100	Set of 4 shelves, grey/chrome	15 3/4" (400 mm)	16 1/4" (412 mm)
C	2533140100	Set of 4 shelves, grey/chrome	17 3/4" (450 mm)	18 1/4" (462 mm)
C	2534140100	Set of 4 shelves, grey/chrome	21 5/8" (550 mm)	22 1/8" (562 mm)

### 4 Single shelf (optional)

Fig.	Code	Description	Shelf width	Min. int. width required
D	1531140100	Single shelf <i>Lavidó</i> , grey/chrome	15 3/4" (400 mm)	16 1/4" (412 mm)
D	1531140150	Single shelf <i>Lavidó</i> , maple/chrome	15 3/4" (400 mm)	16 1/4" (412 mm)
D	1533140100	Single shelf <i>Lavidó</i> , grey/chrome	17 3/4" (450 mm)	18 1/4" (462 mm)
D	1533140150	Single shelf <i>Lavidó</i> , maple/chrome	17 3/4" (450 mm)	18 1/4" (462 mm)
D	1534140100	Single shelf <i>Lavidó</i> , grey/chrome	21 5/8" (550 mm)	22 1/8" (562 mm)
D	1534140150	Single shelf <i>Lavidó</i> , maple/chrome	21 5/8" (550 mm)	22 1/8" (562 mm)



A Frame



B Runner



C Maple finish



C Grey melamine finish



Minimum int. depth required: 19 3/4" (500 mm)



Always ensure that shelves are adjusted in height to prevent any interference with door hinges



FOOD STORAGE STORAGE

## PANTRY AND FULL-HEIGHT CABINETS

## CONVOY CENTRO SLIDING SHELF SYSTEM



*The most sophisticated sliding system on the market!*

Convoy Centro is a door-mounted sliding shelf system with height-adjustable, fully customizable baskets.



- + Each unit comprises a door-mounted frame, a runner and shelves (four or five depending on the suggested interior height).
- + The unique tubular frame is concealed behind the door.
- + Power-assisted opening and closing, made possible by the performance of our synchronized sliding mechanism – a world first!
- + Easy, customizable vertical shelf adjustment.
- + The shelves are made of non-slip melamine (CARB-certified) with elegant glass and chrome contour.
- + The shelves can be accessed from two sides.
- + Four frame heights and three shelf widths are available.
- + This system has a load capacity of 290 lb (130 kg).
- + The top shelf is installed on an internal fixed shelf.



## EASY TO ORDER

The *Convoy Centro* system must comprise a set of four shelves, as it includes the specific top shelf required for assembly.

1

Order a frame according to suggested height.

### 1 Frame

Code	Description	Int. height recommended	Number of shelves recommended
24610100	<i>Convoy Centro</i> frame	43 3/8" to 47 1/4" (1,100 to 1,200 mm)	4
26450100	<i>Convoy Centro</i> frame	59" to 63" (1,500 to 1,600 mm)	5
24670100	<i>Convoy Centro</i> frame	67" to 70 7/8" (1,700 to 1,800 mm)	5
24690100	<i>Convoy Centro</i> frame	74 3/4" to 78 3/4" (1,900 to 2,000 mm)	5

2

Order a runner.

### 2 System runner

Code	Description
24730100	<i>Convoy Centro</i> system runner

3

Order a set of 4 shelves.

### 3 Set of 4 shelves (required)

Code	Description	Shelf width	Min. opening (width)
2571140100	Set of 4 shelves 450, grey/chrome	15 3/4" (400 mm)	16 1/4" (412 mm)
2573140100	Set of 4 shelves 500, grey chrome	17 3/4" (450 mm)	18 1/4" (462 mm)
2574140100	Set of 4 shelves 600, grey/chrome	21 5/8" (550 mm)	22 1/8" (562 mm)

4

Add one or more shelves depending on the suggested height.

### 4 Single shelf (optional)

Code	Description	Shelf width	Min. opening (width)
1571140100	Single shelf 450 grey/chrome	15 3/4" (400 mm)	16 1/4" (412 mm)
1573140100	Single shelf 500 grey/chrome	17 3/4" (450 mm)	18 1/4" (462 mm)
1574140100	Single shelf 600 grey/chrome	21 5/8" (550 mm)	22 1/8" (562 mm)



Required minimum installation depth: 19 3/4" (500 mm)



Easy shelf adjustment



Synchronized opening and closing runner



FOOD STORAGE STORAGE

## PANTRY AND FULL-HEIGHT CABINETS

## DISPENSA FIORO SLIDING SHELF SYSTEM

### *When contemporary meets tradition*

Winner of multiple international design awards, the **Fioro** product range embodies the harmonious fusion of wood and metal.

The warmth of natural wood complemented by the sophistication of anthracite-colored metal lends a distinctive flair to interior design.



- + Sliding system for full shelf access.
- + Frame attached to top and bottom of cabinet.
- + Door-mounted, providing access to contents in a single movement.
- + ClickFixx mechanism quick installation.
- + Load capacity of 220 lb (100 kg) for the 150 model, and of 265 lb (120 kg) for the 300, 400, and 450 models.
- + Soft-close mechanism.
- + Three adjustable frames available for heights from 47 1/4" to 89" (1,200 mm to 2,260 mm).
- + Frame finish: dark grey.
- + Features dark grey metal shelves with natural oak inserts.
- + Available in various shelf widths.
- + Minimalist design with thin shelf walls maximizes storage space.
- + Height-adjustable shelves offer customizable storage space.
- + Partial extension runner – model 150.
- + Full extension runner – models 300, 400 and 450.
- + Door brackets (sold separately).



A Frame



B Partial extension runner



C Full extension runner



D Door fasteners



E Shelf



The oak inserts are easily removable and can be stained to match your preferences, or replaced with glass or alternative materials.

Find detailed specifications on [richelieu.com](http://richelieu.com)

**EASY TO ORDER**

**1**

Order a frame according to suggested height.

**2**

Order a runner.

**3**

Order a pair of door fasteners.

**4**

Order a set of 4 baskets.

**5**

Add one or more shelves depending on the suggested height.

Each basket includes two 87 mm (3 7/16") oak profiles and a non-slip mat, providing an ideal solution for securely storing items in place. Available as a set of one or four baskets.

**1 Frame**

Fig.	Code	Description	Int. height required	Number of shelves recommended	Finish
A	10592906	Frame	47 1/4" to 63" (1,200 to 1,600 mm)	4	Anthracite
A	10594906	Frame	63" to 78 3/4" (1,600 to 2,000 mm)	5 or 6	Anthracite
A	10596906	Frame	71 1/8" to 89" (1,805 to 2,260 mm)	6	Anthracite

**2 Pantry runner**

Fig.	Code	Description	Qty per box	Finish
B	10922906	Partial-extension runner 220 lb (100 kg), 150	1	Anthracite
C	10874906*	Full extension runner 265 lb (120 kg ), 300, 400, 450	1	Anthracite

**3 Pair of door fasteners**

Fig.	Code	Description	Min. int. width required	Qty per box	Finish
D	10892906	Fasteners	4 13/32" (112 mm)	1 pair	Anthracite
D	10585906	Fasteners	10 3/8" (262 mm)	1 pair	Anthracite
D	10586906	Fasteners	14 1/4" (362 mm)	1 pair	Anthracite
D	11000906	Fasteners	16 1/4" (412 mm)	1 pair	Anthracite

**4 Set of 4 shelves (required)**

Fig.	Code	Description	Min. int. width required	Qty per box	Finish
E	10995906	Set of 4 shelves 150	4 13/32" (112 mm)	4	Anthracite and oak
E	10980906	Set of 4 shelves 300	10 3/8" (262 mm)	4	Anthracite and oak
E	10984906	Set of 4 shelves 400	14 1/4" (362 mm)	4	Anthracite and oak
E	10986906	Set of 4 shelves 450	16 1/4" (412 mm)	4	Anthracite and oak

**5 Single shelf (optional)**

Fig.	Code	Description	Min. int. width required	Qty per box	Finish
E	11001906	Single shelf 150	4 13/32" (112 mm)	1	Anthracite and oak
E	10981906	Single shelf 300	10 3/8" (262 mm)	1	Anthracite and oak
E	10985906	Single shelf 400	14 1/4" (362 mm)	1	Anthracite and oak
E	10987906	Single shelf 450	16 1/4" (412 mm)	1	Anthracite and oak

\* The full-extension runner can only be used in a cabinet with an internal width of 10 5/16" (262 mm) or more.

**Additional accessories (optional)**



10142906  
Front stabilizer



10163906  
Additional pair of hooks  
5" (125 mm) high, can be used with the frame when extended to its maximum height.



Installation depth:  
min. 19 7/8" (505 mm).



FOOD STORAGE STORAGE

PANTRY AND FULL-HEIGHT CABINETS

PLENO FIORO SLIDING SHELF SYSTEM



*Achieve perfect harmony inside and out!*

Opening a *Pleno* system door offers unparalleled visibility and exceptional accessibility.



- + Sliding system designed for cabinets with hinged doors.
- + Full access with a single movement.
- + Cinematic design ensures effortless opening and closing, even when shelves are fully loaded.
- + Frame securely fixed to the bottom and side of the cabinet.
- + Reversible frame allows for left or right installation.
- + Door fasteners included: system runners out of the cabinet when the door is opened.
- + Load capacity of 220 lb (100 kg).
- + Features a soft-close mechanism.
- + Requires a minimum interior height of 74 13/16" (1,900 mm).
- + Suitable for a minimum interior width of 16 1/4" (412 mm) or 22 15/16" (582 mm).
- + Frame finish: dark grey.
- + Features dark grey metal shelves with natural oak inserts.
- + Minimalist design with thin shelf walls maximizes storage space.
- + Height-adjustable shelves offer customizable storage space.



The oak inserts are easily removable and can be stained to match your preferences, or replaced with glass or alternative materials.

Find detailed specifications on [richelieu.com](http://richelieu.com)

A *Pleno* system

Fig.	Code	Description	Int. width required	Min. int. height	Min. int. depth
A	10988906	<i>Pleno</i> 450, dark grey	min. 16 1/4" (412 mm)	74 3/4" (1,900 mm)*	19 7/8" (505 mm)
A	10989906	<i>Pleno</i> 600, dark grey	min. 22 1/8" (562 mm)	74 3/4" (1,900 mm)*	19 7/8" (505 mm)



\* The 74 3/4" (1,900 mm) height includes an additional 7 1/4" (185 mm) for container storage on the top shelf.



**Extendo sliding shelves**

- + Sturdy metal shelves.
- + Features a natural oak finish, adding a touch of modern elegance.
- + Ideal for installation in pantry cabinets or other spaces, including base cabinet, living room furniture, walk-in closet, bedroom, and more.
- + Sold individually.
- + Compatible with several concealed runner models (sold separately).
- + Visit our website for a list of recommended runners.
- + Load capacity varies based on the chosen runners.
- + Suitable for both framed and frameless cabinets; requires the use of two spacers (sold separately) that can be used with framed cabinets.

Fig.	Code	Description	Min. int. width
A	22125906	Extendo 450, dark grey	16 1/4" to 16 1/2" (412 to 418 mm)
A	22126906	Extendo 600, dark grey	22 1/8" to 22 3/8" (562 to 568 mm)
A	22127906	Extendo 900, dark grey	33 15/16" to 34 3/16" (862 to 868 mm)



A Extendo shelf



The minimum interior depth required is 20" (508 mm) and the minimum interior height required is 4 3/4" (120 mm).



The oak profiles are easily removable and can be stained to match your preferences, or replaced with glass or alternative materials.

Find detailed specifications on [richelieu.com](http://richelieu.com)



**Clickstop**

- + The automatic locking system effortlessly secures any sliding wooden shelf (such as Extendo or other) in the open position.
- + Instantly transforms space into a functional area.
- + Unlock and lock with ease in a single, seamless motion.



B Recommended spacer for installation in a framed cabinet



C Clickstop automatic locking system

Fig.	Code	Description	Min. int. height
B	2223906	1" (25 mm) spacer	1" (25 mm)
C	2666906	Clickstop automatic locking system	2 3/16" (55 mm)



FOOD STORAGE STORAGE

PANTRY AND FULL-HEIGHT CABINETS

DISPENSA SLIDING SHELF SYSTEM

*The most versatile pantry cabinet system on the market*



- + Dispensa is a full-access sliding shelf system.
- + Suitable for installation in spaces with a minimum interior width of 10 5/16" (262 mm).
- + Adaptable to any interior height ranging from 47 1/4" to 90 5/8" (1,200 to 2,300 mm).
- + Secures to the bottom and top of the cabinet, as well as to the door.
- + Features height-adjustable shelves available in various finishes.
- + Can be equipped with an optional Softstopp system.
- + Door fasteners ensure effortless single-motion opening.
- + The grey metal frame has a load capacity of 220 lb (100 kg).
- + Chrome-plated wire shelves or Arena are made of CARB-certified non-slip melamine and metal contour.

EASY TO ORDER

1 Order frame

Min. int. depth of 19 11/16" (500 mm)

Set of frame + runners + door mounting bracket (grey finish)	Optional adjustable mounting post (grey finish)	Number of shelves recommended
--	---	-------------------------------

Code	Code	Int. height	
<b>Min. int. depth of 19 11/16" (500 mm)</b>	<b>Int. height</b>		
74260100	4215100	47 1/4" to 63" (1,200 to 1,600 mm)	4
74382100	4216100	63" to 78 3/4" (1,600 to 2,000 mm)	6
74383100	4217100	74 3/4" to 90 1/2" (1,900 to 2,300 mm)	8

Min. int. depth of 14 1/4" (362 mm)

84260100	4215100	47 1/4" to 63" (1,200 to 1,600 mm)	4
84382100	4216100	63" to 78 3/4" (1,600 to 2,000 mm)	6
84383100	4217100	74 3/4" to 90 1/2" (1,900 to 2,300 mm)	8

Min. int. depth of 16 1/4" (412 mm)

94260100	4215100	47 1/4" to 63" (1,200 to 1,600 mm)	4
94382100	4216100	63" to 78 3/4" (1,600 to 2,000 mm)	6
94383100	4216100	74 3/4" to 90 1/2" (1,900 to 2,300 mm)	8







**A** Chrome wire shelf



**B** Non-slip melamine shelf in maple finish with chrome contour

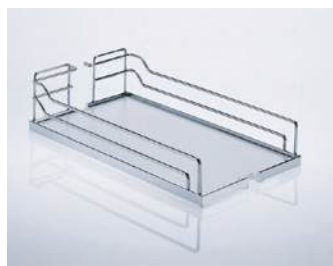

**C** Non-slip melamine shelf in silver-grey finish with chrome contour



**D** Anthracite-finish non-slip shelf with flat contour

## 2 Order the shelves of your choice (sold individually)

Fig.	Code	Min. width	Description (W x D x H)	Finish
<b>A</b>	1886140	10 5/16" (262 mm)	Chrome wire shelf 9 27/32" x 18 3/8" x 4 11/32" (250 x 468 x 110 mm)	Chrome
<b>A</b>	1887140	14 1/4" (362 mm)	Chrome wire shelf 13 3/4" x 18 3/8" x 4 11/32" (350 x 468 x 110 mm)	Chrome
<b>A</b>	1973140	16 1/4" (412 mm)	Chrome wire shelf 15 3/4" x 18 3/8" x 4 11/32" (400 x 468 x 110 mm)	Chrome
<b>B</b>	4385140150	10 5/16" (262 mm)	Non-slip shelf 9 27/32" x 18 1/4" x 4 3/16" (250 x 462 x 106 mm)	Maple/chrome
<b>B</b>	4386140150	14 1/4" (362 mm)	Non-slip shelf 13 3/4" x 18 1/4" x 4 3/16" (350 x 462 x 106 mm)	Maple/chrome
<b>B</b>	4390140150	16 1/4" (412 mm)	Non-slip shelf 15 3/4" x 18 1/4" x 4 3/16" (400 x 462 x 106 mm)	Maple/chrome
<b>B</b>	4395140150	18 1/4" (462 mm)	Non-slip shelf 17 3/4" x 18 1/4" x 4 3/16" (450 x 462 x 106 mm)	Maple/chrome
<b>B</b>	4396140150	22 1/8" (562 mm)	Non-slip shelf 21 3/8" x 18 1/4" x 4 3/16" (550 x 462 x 106 mm)	Maple/chrome
<b>C</b>	4385140100	10 5/16" (262 mm)	Non-slip shelf 9 27/32" x 18 1/4" x 4 3/16" (250 x 462 x 106 mm)	Grey/chrome
<b>C</b>	4386140100	14 1/4" (362 mm)	Non-slip shelf 13 3/4" x 18 1/4" x 4 3/16" (350 x 462 x 106 mm)	Grey/chrome
<b>C</b>	4390140100	16 1/4" (412 mm)	Non-slip shelf 15 3/4" x 18 1/4" x 4 3/16" (400 x 462 x 106 mm)	Grey/chrome
<b>C</b>	4395140100	18 1/4" (462 mm)	Non-slip shelf 17 3/4" x 18 1/4" x 4 3/16" (450 x 462 x 106 mm)	Grey/chrome
<b>C</b>	4396140100	22 1/8" (562 mm)	Non-slip shelf 21 3/8" x 18 1/4" x 4 3/16" (550 x 462 x 106 mm)	Grey/chrome
<b>D</b>	4385906906	10 5/16" (262 mm)	Non-slip shelf 9 27/32" x 18 1/4" x 4 3/16" (250 x 462 x 106 mm)	Anthracite/anthracite
<b>D</b>	4386906906	14 1/4" (362 mm)	Non-slip shelf 13 3/4" x 18 1/4" x 4 3/16" (350 x 462 x 106 mm)	Anthracite/anthracite
<b>D</b>	4390906906	16 1/4" (412 mm)	Non-slip shelf 15 3/4" x 18 1/4" x 4 3/16" (400 x 462 x 106 mm)	Anthracite/anthracite

## 3 Add options



4276100 Set of two additional brackets, silver-grey



14237100 SoftStopp shock-absorbing mechanism, silver grey



4215100, 4216100, 4217100 Optional adjustable mounting posts

Int. height	Number of recommended brackets
52 3/16" to 57 1/16" (1,325 to 1,449 mm)	1
57 1/8" to 62" (1,450 to 1,574 mm)	2
67 7/8" to 72 3/4" (1,725 to 1,849 mm)	1
72 3/4" to 77 3/4" (1,850 to 1,974 mm)	2
79 3/4" to 84 5/8" (2,025 to 2,149 mm)	1
84 5/8" to 89 1/2" (2,150 to 2,274 mm)	2

If your internal height is not shown in the table, you do not need additional brackets.



### 4276100

To add shelves and optimize full-height storage, order additional brackets. One set includes a pair for shelf contents.

### 4215100, 4216100, 4217100

Adjustable mounting posts are optional but provide additional stability and are recommended in the following applications: Interior height greater than 63" (1,600 mm) or when using two doors.



FOOD STORAGE STORAGE

## PANTRY AND FULL-HEIGHT CABINETS

## DISPENSA ANTHRACITE SLIDING SHELF SYSTEM



- + Dispensa sliding shelf systems feature a trendy anthracite finish.
- + Designed to fit into spaces with a minimum interior width of 10 5/16" (262 mm).
- + Adaptable to any interior height ranging from 47 1/4" to 89" (1,200 to 2,260 mm).
- + Securely attaches to the bottom and top interior of the cabinet, as well as to the door.
- + Access cabinet contents in a single movement.
- + Shelves are height-adjustable as needed.
- + The shock-absorbing closing system is included.
- + Features a load capacity of 220 lb (100 kg).
- + Arena shelves are crafted from CARB-certified non-slip anthracite melamine and sleek flat anthracite metal contour.



A Frame



B Runners



C Door fasteners



D Shelves



10142906  
Front stabilizer



10163906  
Pair of additional hooks  
5" (125 mm) height  
Can be used with frame  
when extended to  
maximum height.



Min. installation depth required : 19 5/8" (505 mm)

### EASY TO ORDER

#### 1 Order frame

Fig.	Code	Description	Int. height required	Number of shelves recommended	Finish
A	10592906	Frame	47 1/4" to 63" (1,200 to 1,600 mm)	4	Anthracite/anthracite
A	10594906	Frame	63" to 78 3/4" (1,600 to 2,000 mm)	5 or 6	Anthracite/anthracite
A	10596906	Frame	71 1/16" to 89" (1,805 to 2,260 mm)	6	Anthracite/anthracite

#### 2 Order a set of pantry runners

Fig.	Code	Description	Qty/box	Finish
B	10874906	Full extension runner 120 kg	1	Anthracite/anthracite

#### 3 Order a pair of door fasteners

Fig.	Code	Description	Min. int. width required	Qty/box	Finish
C	10585906	Door fasteners	10 5/16" (262 mm)	1 pair	Anthracite/anthracite
C	10586906	Door fasteners	14 1/4" (362 mm)	1 pair	Anthracite/anthracite
C	11000906	Door fasteners	16 1/4" (412 mm)	1 pair	Anthracite/anthracite

#### 4 Order the desired number of shelves (sold individually)

Fig.	Code	Description	Min. int. width required	Qty/box	Finish
D	4385906906	Arena 250 shelf	10 5/16" (262 mm)	1	Anthracite/anthracite
D	4386906906	Arena 350 shelf	14 1/4" (362 mm)	1	Anthracite/anthracite
D	4390906906	Arena 400 shelf	16 1/4" (412 mm)	1	Anthracite/anthracite



- + Pull-out shelf system for pantry cabinets – frame, shelves and door shelf set included.
- + A set of four or six door shelves provides additional storage space.
- + Arena shelves (CARB-certified non-slip melamine, in maple or silver-grey finish, with chrome contour).
- + The inner frame slides out for easy access and a clear view of items.
- + Choice of simple assembly: the frame, mounted on the bottom and side of the cabinet, is reversible, and can be installed on the right or left side.
- + Integrated soft-closing device.
- + Two interior heights: min. 43 5/16" (1,100 mm) and min. 66 7/8" (1,700 mm).
- + Three interior widths: min. 16 3/16" (412 mm), min. 18 3/16" (462 mm), min. 22 1/8" (562 mm).
- + Load capacity per system: 188 lb (85 kg).

EASY TO ORDER

1

Order a frame.

2

Order the number of shelves required.

3

Order a set of door shelves.



A Frame

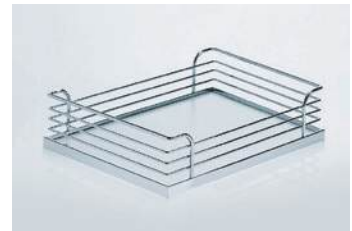

B Grey/chrome non-slip melamine shelf

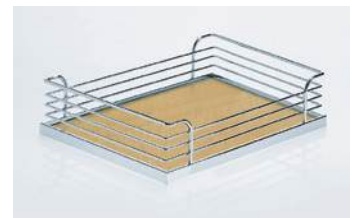

B Maple/chrome non-slip melamine shelf



C Door shelves (4 or 6 shelves)

1 Frame					
Fig.	Code	Description	Min. int. width	Min. int. depth	Min. int. height
A	23430100	Metal frame	16 1/4" (412 mm)	19 11/16" (500 mm)	43 5/16" (1,100 mm)
A	23435100	Metal frame	18 3/16" (462 mm)	19 11/16" (500 mm)	43 5/16" (1,100 mm)
A	23440100	Metal frame	22 1/8" (562 mm)	19 11/16" (500 mm)	43 5/16" (1,100 mm)
A	23432100	Metal frame	16 1/4" (412 mm)	19 11/16" (500 mm)	43 5/16" (1,100 mm)
A	23437100	Metal frame	18 3/16" (462 mm)	19 11/16" (500 mm)	43 5/16" (1,100 mm)
A	23442100	Metal frame	22 1/8" (562 mm)	19 11/16" (500 mm)	43 5/16" (1,100 mm)

2 Set of 2 shelves						
Fig.	Grey/chrome	Maple/chrome	Min. int. width	Min. int. depth	# of shelves 1,100 mm height	# of shelves 1,700 mm height
B	3434140100	3434140150	16 1/4" (412 mm)	19 11/16" (500 mm)	4	6
B	3439140100	3439140150	18 3/16" (462 mm)	19 11/16" (500 mm)	4	6
B	3444140100	3444140150	22 1/8" (562 mm)	19 11/16" (500 mm)	4	6

3 Set of 4 door shelves for 43 5/16" height					
Fig.	Grey/chrome	Maple/chrome	Min. int. width	Min. int. depth	Min. int. height
C	3431140100	3431140150	16 1/4" (412 mm)	19 11/16" (500 mm)	43 5/16" (1,100 mm)
C	3436140100	3436140150	18 3/16" (462 mm)	19 11/16" (500 mm)	43 5/16" (1,100 mm)
C	3441140100	3441140150	22 1/8" (562 mm)	19 11/16" (500 mm)	43 5/16" (1,100 mm)

3 Set of 6 door shelves for 66 7/8" height					
Fig.	Grey/chrome	Maple/chrome	Min. int. width	Min. int. depth	Min. int. height
C	3433140100	3433140150	16 1/4" (412 mm)	19 11/16" (500 mm)	66 7/8" (1,700 mm)
C	3438140100	3438140150	18 3/16" (462 mm)	19 11/16" (500 mm)	66 7/8" (1,700 mm)
C	3443140100	3443140150	22 1/8" (562 mm)	19 11/16" (500 mm)	66 7/8" (1,700 mm)



FOOD STORAGE STORAGE

## PANTRY AND FULL-HEIGHT CABINETS

## DISPENSA U.S. SLIDING SHELF SYSTEM



### *The pantry system that does more!*

The *Dispensa US* is tailored to cater to the demands of the North American market, featuring an expanded selection of shelf sizes and enhanced storage capacity due to its increased depth.

With its full extension sliding shelf system, accessing your items becomes effortless. Additionally, the height of the shelves is adjustable to accommodate individual preferences.

Gain a quick overview and easy access to your pantry essentials. Available in silver grey and chrome or maple and chrome finishes.



- + Sliding shelf system for both framed and frameless cabinets.
- + Nine shelf widths.
- + Universally compatible: shelves can also integrate with our *BPO II* base cabinet pull-out system.
- + Optimized design: shelves are 20 3/8" (518 mm) deep.
- + *Arena* shelves feature CARB-certified non-slip melamine, offered in maple or silver-grey finishes, with chrome contour.
- + Secure attachment to both the top and bottom of the cabinet.
- + Equipped with a shock-absorbing mechanism for gentle, cushioned closing.
- + Offers full access to the cabinet interior with a single fluid movement.
- + Load capacity of up to 265 lb (120 kg).
- + Adjustable frame allows for heights ranging from 31 1/2" to 90 1/2" (800 to 2,300 mm).



Silver grey and chrome



Maple and chrome

**EASY TO ORDER**

**1**

Order a frame.

**2**

Order the number of sets of two shelves.

**1 Frame\***

Fig.	Code	Int. height required	Number of sets of 2 shelves recommended	Finish
A	24160100	31 1/2" to 47 1/4" (800 to 1,200 mm)	1 or 2 sets of 2 baskets	Grey
A	24260100	47 1/4" to 62 7/8" (1,200 to 1,600 mm)	2 or 3 sets of 2 baskets	Grey
A	24382100	62 7/8" to 78 3/4" (1,600 to 2,000 mm)	3 or 4 sets of 2 baskets	Grey
A	24383100	74 3/4" to 90 1/2" (1,900 to 2,300 mm)	3 or 4 sets of 2 baskets	Grey

\* Includes frame, runners, door brackets and integrated soft-closing mechanism

**Frame cabinet**

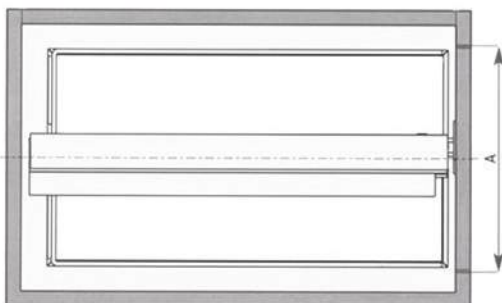

(Minimum opening width required)

**Frameless cabinet**

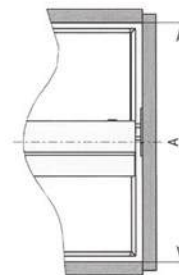

(Minimum opening width required)

**2 Set of 2 Arena shelves**

Fig.	Grey/chrome	Maple/chrome	Shelves dimensions (W x D x H)	Min. opening width (A)
B	25140100	25140150	8" x 20 3/8" x 4 1/8" (203 x 518 x 105 mm)	8 1/2" (216 mm)
B	35140100	35140150	10" x 20 3/8" x 4 1/8" (254 x 518 x 105 mm)	10 1/2" (267 mm)
B	26140100	26140150	11" x 20 3/8" x 4 1/8" (279 x 518 x 105 mm)	11 1/2" (292 mm)
B	36140100	36140150	13" x 20 3/8" x 4 1/8" (330 x 518 x 105 mm)	13 1/2" (343 mm)
B	27140100	27140150	14" x 20 3/8" x 4 1/8" (356 x 518 x 105 mm)	14 1/2" (368 mm)
B	37140100	37140150	16" x 20 3/8" x 4 1/8" (406 x 518 x 105 mm)	16 1/2" (419 mm)
B	28140100	28140150	17" x 20 3/8" x 4 1/8" (432 x 518 x 105 mm)	17 1/2" (445 mm)
B	38140100	38140150	19" x 20 3/8" x 4 1/8" (483 x 518 x 105 mm)	19 1/2" (495 mm)
B	39140100	39140150	20" x 20 3/8" x 4 1/8" (508 x 518 x 105 mm)	20 1/2" (520 mm)

**3 Optional accessories**

Fig.	Code	Description	Finish
C	4276100	Shelf bracket	Grey
D	4350100	Bracket for frame	Grey



Depth: 21 1/2" (546 mm)



4276100 Shelf bracket



4350100 Bracket for frame



FOOD STORAGE STORAGE

## PANTRY AND FULL-HEIGHT CABINETS

## SLIDING SYSTEMS FOR HINGED DOORS



Product shown: version with two frames



### Interior installation dimensions:

D = min. 19 11/16" (500 mm)  
 H = adjustable from 45 11/16" to 58 7/8" (1,160 to 1,495 mm)  
 W = basket width + 2" (50 mm)

*See it in  
the blink of an eye*

Pull-out basket systems designed for hinged doors offer easy installation options at both the top and bottom (interior) of cupboards.

With a partial-extension pull-out basket system, you can effortlessly view the entire contents of your pantry at a glance!



- + The frame features hooks on one side specifically designed for use with chrome-plated wire baskets.
- + The reversible frame is made from grey metal, the basket from chrome-plated wire.
- + Attachable to both the top and bottom of the cabinet, allowing for installation of two frames side by side, depending on the available width.
- + With multiple hooks, you can position several baskets according to the height of the items to be stored.
- + Suitable for hinged doors only.



A Frame



B Standard chrome wire basket



C Basket in thick chrome wire

### 1 Frame

Fig.	Code	Description	Finish
A	7288100	Reversible frame H: 45 11/16" to 58 7/8" (1,160 to 1,495 mm)	Grey

### 2 Set of baskets

Fig.	Code	Description	Finish
B	6085140	4 11/32" x 3" (110 x 75 mm) basket	Chrome
B	6086140	6 5/16" x 3" (160 x 75 mm) basket	Chrome
B	6087140	7 1/2" x 3" (190 x 75 mm) basket	Chrome
B	6291140	8 11/16" x 3" (220 x 75 mm) basket	Chrome
B	6090140	12 1/4" x 3" (310 x 75 mm) basket	Chrome
C	5140140	4 11/32" x 3" (110 x 75 mm) basket	Thick chrome
C	5141140	6 5/16" x 3" (160 x 75 mm) basket	Thick chrome
C	5142140	8 9/32" x 3" (210 x 75 mm) basket	Thick chrome
C	5143140	12 5/8" x 3" (320 x 75 mm) basket	Thick chrome

## To reach new heights

In the kitchen, step stools prove highly practical for accessing items stored at higher levels. They conveniently fold away for compact storage when not in use, and they seamlessly fit into any room of the house.



### Step-Fix

- + The **#4410905** retractable step stool is 3 15/16" (100 mm) thick and offers storage placement options:
  - It can be stored in a cabinet or mounted on a wall using bracket **#4495905**.
  - It can slide under the toe-kick with the **#44962G** support and caster set (customer-made toe-kick front required).
- + When unfolded, the 13 3/4" (350 mm) step stool facilitates easy access to stored items.
- + Enhanced safety is ensured with non-slip rubber feet.
- + The step stool load capacity is 330 lb (150 kg).



A Step-Fix step stool



B Step-Fix toe-kick kit (optional)



C Step-Fix wall-mounting bracket (optional)



### Stepulo

- + When unfolded, the 28 1/4" (718 mm) high step stool makes it easy to reach stored items.
- + The tall folding step stool **#6340900** includes a wall bracket.
- + With a thickness of just 1 1/2" (38 mm), it easily stows away inside a cabinet.
- + Available in a sleek matte black finish.
- + Load capacity of 330 lb (150 kg).



D Stepulo tall step stool

Fig.	Code	Description	Product dimensions when open (W x D x H)			Finish
			Width	Depth	Height	
A	4410905	Step-Fix foldable step stool	16" (405 mm)	15 3/8" (390 mm)	15" (382 mm)	Graphite
B	44962G	Bracket and caster set for toe kick*	N/A	N/A	N/A	Chrome
C	4495905	Step-Fix wall support	5 1/2" (144 mm)	1 1/2" (37 mm)	1 3/16" (30 mm)	Graphite
D	6340900	Stepulo tall folding step stool	16 1/2" (418 mm)	Min. 21 1/16" (550 mm)	28 1/4" (718 mm)	Matte black

\* Toe-kick application: there must be a minimum width of 16" (405 mm) between the box feet and a minimum height of 4 1/8" (105 mm) for this application.



FOOD STORAGE STORAGE

## PANTRY AND FULL-HEIGHT CABINETS

## SESAM STORAGE SYSTEM FOR BROOM CUPBOARDS

### *A well-kept secret*

This complete system enables smart, organized storage of broom cupboards.



- + This rack-and-pinion system is versatile, suitable for installation on either side of the cabinet.
- + The rack plate effortlessly mounts on the cabinet's interior with just a few screws.
- + Height adjustment of the three trays ensures optimal container storage.
- + Trays edges are designed to prevent objects from slipping out.
- + The vacuum hose holder ranging from 1 3/8" to 2 1/8" (35 to 55 mm) in diameter maximizes space for other storage items.
- + Each tray features two hooks on the side for hanging various objects, including brooms and other essentials.
- + Features a load capacity of 15 lb (7 kg) per tray.
- + This system is available in a trendy aluminum grey color.
- + The complete set comes in a single box, featuring a unique code for each order.

Complete set includes  
1 rack plate  
(side-mounted),  
3 trays,  
2 multi-purpose  
hooks and 1 vacuum  
hose holder.



A Complete set



Three trays to clip onto rack plate



Vacuum hose holder

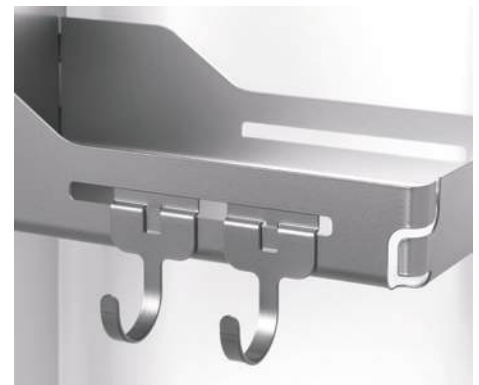

Two hooks for hanging on the sides of the trays

Fig.	Code	Description	Min. int. dimensions required (W x D x H)	Finish
A	6356110	Storage system for broom cupboard	14 1/4" x 16 7/8" x 29 5/8" (362 x 430 x 752 mm)	Aluminum grey





Shown product: Sesam broom holder including two hooks (6360110) or tray kit (6356110)

*Little extras*



**A** Sesam broom holder  
**B** Sesam single hook, can be used for broom holder (6360110) or tray kit (6356110)



**C** Sesam rail with six hooks



**D** Screw-on tray



**E** Rail with five screw-on hooks

**Additional accessories**

Fig.	Code	Description	Product dimensions (W x D x H)	Finish
<b>A</b>	6360110	Sesam broom holder	2 15/16" x 13" x 3 5/16" (75 x 330 x 85 mm)	Aluminum grey
<b>B</b>	6359110	Sesam individual hook	1 7/8" x 1 7/8" x 3 1/2" (50 x 48 x 89 mm)	Aluminum grey
<b>C</b>	6361110	Sesam rail with 6 hooks	1 3/4" x 14 3/16" x 2 3/8" (45 x 360 x 60 mm)	Aluminum grey
<b>D</b>	5130140	Screw-on tray	11 5/8" x 3 15/16" x 4 3/8" (295 x 100 x 110 mm)	Chrome
<b>E</b>	1077140	Screw-on rail with 5 hooks	13 3/4" x 1 3/16" x 2 1/8" (350 x 30 x 54 mm)	Chrome



## The art of organizing drawers

From knives, utensils to ladles, Richelieu dividers ensure every item finds its spot! A tidy drawer not only saves time but also enhances the joy of cooking. Explore a range of finishes and materials for personalized perfection!

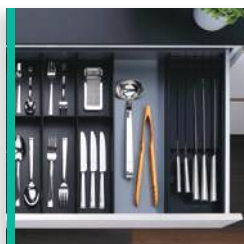

*Straightline*

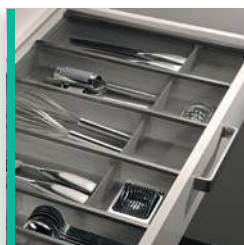

*Cuisio*

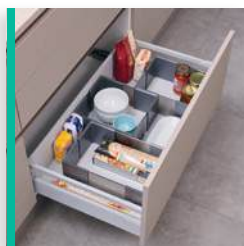

*Cuisio Flex*



*Classico*

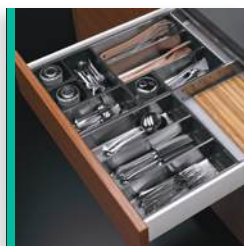

*Organiz-R*

<i>Straightline</i> dividers	24
<i>Deco</i> anti-slip mats	27
<i>Cuisio</i> translucent dividers	28
<i>Cuisio Flex</i> deep drawer system	29
<i>Connect 2.0</i> drawer dividers	30
<i>Classico</i> drawer dividers	32
<i>Separado</i> utensil dividers	33
<i>Organiz-R</i> drawer system	34
Cutlery and utensil dividers	37
Spice dividers	38
Single and double dividers	39
Large-format flexible anti-slip mats and <i>Econo</i> mat	40
<i>Rivero</i> two-way drawer system	41



STORAGE PREPARATION COOKING



Birch



Walnut



Black ash

## A multitude of possibilities and diverse combinations

**Straightline** presents a series of modular dividers crafted from solid wood, offering versatility in three distinct species: birch, walnut, and black ash.

This customizable system guarantees impeccable drawer organization. Discover a selection of 144 configurations on our website, catering to drawer widths ranging from 6" (154 mm) to 46" (1,154 mm).



- + There are endless possibilities for various drawer dimensions.
- + Birch, walnut, and black ash, three popular wood types that bring a cozy touch to your drawer interiors.
- + This comprehensive range of components meets all storage needs in standard or deep drawers.
- + Adjustable to fit drawer depths ranging from 16 3/4" (424 mm) to 20 7/8" (529 mm) with an extension (I).
- + Perfect for organizing knives, spices, utensils, and even a wrapping paper dispenser – essentially, everything you frequently use in the kitchen, conveniently accessible at any moment.

### Configuration examples



**Shanghai**  
Interior width 23 7/8" to 27 3/8" (606 to 695 mm)



**Moscow**  
Interior width 18" to 21 1/2" (456 to 545 mm)



**Honolulu**  
Inside width from  
6 1/16" to 9 9/16"  
(154 to 243 mm)



**Tokyo**  
Interior width 35 7/8" to 39 3/8" (912 to 1,001 mm)



**Portland**  
Interior width 12" to 15 1/2" (306 to 395 mm)



**Interior depth required:**  
16 3/4" to 20 7/8" (424 to 529 mm)



STORAGE



PREPARATION



COOKING

**Components for standard drawers**

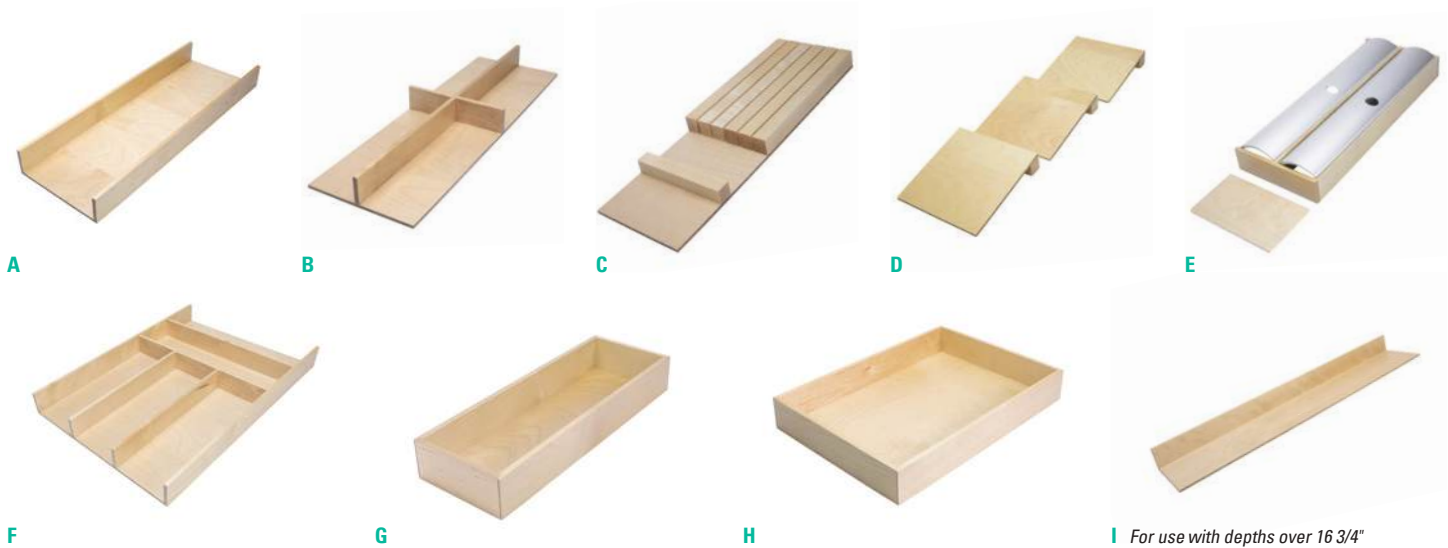

I For use with depths over 16 3/4"

Fig.	Birch	Walnut	Black Ash	Description	Product dimensions (W x D x H)
A	250530031	250530161	250530900	Multifunctional divider	6" x 16 3/4" x 1 11/16" (150 x 424 x 43 mm)
B*	250532031	250532161	250532900	Cross divider	5 13/32" x 16 3/4" x 1 15/32" (137 x 424 x 38 mm)
C*	250534031	250534161	250534900	Knife block insert	5 13/32" x 16 3/4" x 1 1/32" (137 x 424 x 26 mm)
D*	250533031	250533161	250533900	Divider for spices	5 13/32" x 16 3/4" x 1 1/32" (137 x 424 x 26 mm)
E*	250535031	250535161	250535900	Wrapping paper dispenser	5 13/32" x 16 3/4" x 1 15/16" (137 x 424 x 50 mm)
F	250526031	250526161	250526900	Divider for utensils	11 3/4" x 16 3/4" x 1 11/16" (300 x 424 x 43 mm)
G	250531031	250531161	250531900	Multifunctional divider	11 3/4" x 4 5/32" x 1 11/16" (300 x 106 x 43 mm)
H	250540031	250540161	250540900	Wood tray	11 3/4" x 8 5/16" x 1 11/16" (300 x 211 x 43 mm)
I	250527031	250527161	250527900	Extension for depth	23 5/8" x 4 1/8" x 1 11/16" (600 x 105 x 43 mm)
I	250555031	250555161	250555900	Extension for depth	36" x 4 1/8" x 1 11/16" (914 x 105 x 43 mm)
I	250528031	250528161	250528900	Extension for depth	47 1/4" x 4 1/8" x 1 11/16" (1,200 x 105 x 43 mm)

\* For use with divider (A).

**Accessories for standard drawers**



J Aluminum connector for securing components in place.



K Metal divider for H



L Metal divider for G



M These pads clip onto the underside of the metal divider, providing a non-slip surface and preventing scratches on the bottom of the drawer. Sold in packs of 25.



For improved functionality and visual appeal in your drawer, we suggest incorporating a *DECO* non-slip mat.

Fig.	Code	Description	Product dimensions (W x D x H)	Finish
J	250529010	Connection clip	1 9/16" x 1/2" x 1/2" (40 x 13 x 13 mm)	Aluminium
K	250549910	Metal cross divider	11 1/4" x 7 3/4" x 1 1/2" (286 x 197 x 37 mm)	Graphite
L	250547910	U-Shape metal divider	3 5/8" x 3 7/8" x 1 1/2" (92 x 98 x 37 mm)	Graphite
M	250543990	Non-slip bumpers (Qty. 25)		Black



STORAGE



PREPARATION



COOKING

## DRAWERS AND DIVIDERS

## STRAIGHTLINE DRAWER DIVIDERS



### Components for deep drawers

The *Straightline* collection offers an elegant selection of components for deep drawers, providing a practical solution for organizing a variety of items such as dinnerware, pantry goods, cans and beyond.

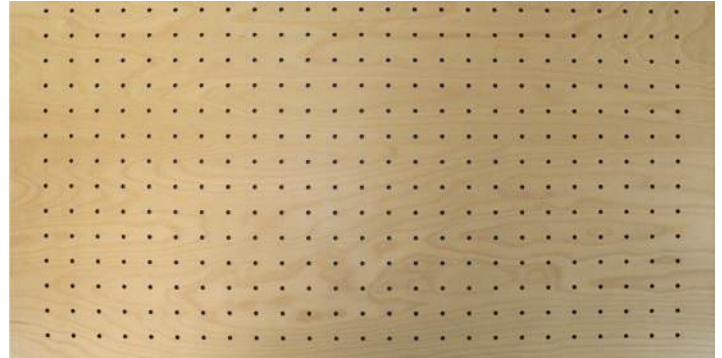

A Perforated panel



You will need a perforated panel (to be cut to size) to hold dividers, pegs and accessories according to your storage needs.



B Set of 4 pegs



C Large divider



D Short divider



E Rectangular box



F Square box

Fig.	Birch	Walnut	Black Ash	Description	Product dimensions (W x D x H)
A	250541031	250541161	250541900	Perforated panel	38 5/8" x 22" x 3/8" (854 x 559 x 9 mm)
B	250544031	250544161	250544900	Set of 4 pegs	1" x 1" x 6 5/16" (25 x 25 x 160 mm)
C	250546031	250546161	250546900	Large divider	18 13/16" x 1/2" x 4 3/4" (478 x 12 x 120 mm)
D	250545031	250545161	250545900	Short divider	7 1/2" x 1/2" x 4 3/4" (190 x 12 x 120 mm)
E	250538031	250538161	250538900	Rectangular box	8 3/8" x 16 11/16" x 4 5/16" (212 x 424 x 110 mm)
F	250539031	250539161	250539900	Square box	8 3/8" x 8 3/8" x 4 5/16" (212 x 212 x 110 mm)



STORAGE



PREPARATION



COOKING

## Functional elegance!

In addition to serving the practical purposes of anti-slip and protection, these soft mats allow you to personalize your kitchen or wardrobe drawers to match your personal style. They are the perfect complement to our *Straightline*, *Connect*, *Cuisio*, or *Separado* drawer divider collections, allowing for a multitude of potential combinations!



- + The ideal product to optimize and personalize the interior of your drawers with high-quality protective mats.
- + Available in nine trendy finishes: clay, brown, green sage, black, taupe, grey, anthracite, jade blue, and plum.
- + Delivered flat in large, individual sheets, these flexible mats are easy to cut to size.
- + The non-slip surface effectively prevents items from shifting within drawers.
- + Provide protection and soundproofing for wooden or metal drawer bottoms.
- + This product is waterproof and easy to clean.
- + These mats are ideal for cutlery dividers or for lining wardrobe drawer bottoms.

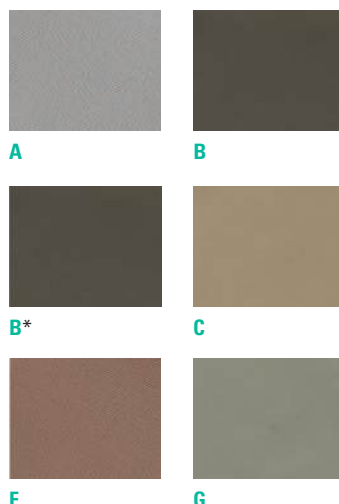

Fig.	Code	Description	Max. int. dimensions (W x D)
A	6115211100	Deco mat, grey	43 5/16" x 23 5/8" (1,100 mm x 600 mm)
B	6115212906	Deco mat, anthracite	43 5/16" x 23 5/8" (1,100 mm x 600 mm)
B*	6215212906	Antibacterial mat, anthracite	43 5/16" x 23 5/8" (1,100 mm x 600 mm)
C	6115202040	Deco mat, taupe	43 5/16" x 23 5/8" (1,100 mm x 600 mm)
D	6115217090	Deco mat, black	43 5/16" x 23 5/8" (1,100 mm x 600 mm)
E	6115211007	Deco mat, clay	43 5/16" x 23 5/8" (1,100 mm x 600 mm)
F	6115211060	Deco mat, brown	43 5/16" x 23 5/8" (1,100 mm x 600 mm)
G	6115211117	Deco mat, green sage	43 5/16" x 23 5/8" (1,100 mm x 600 mm)
H	6115211070	Deco mat, blue jade	43 5/16" x 23 5/8" (1,100 mm x 600 mm)
I	6115211364	Deco mat, prune	43 5/16" x 23 5/8" (1,100 mm x 600 mm)

\* The antibacterial efficacy is permanent and requires no additional treatment, as the silver ions are integrated into the raw material during production.



## DRAWERS AND DIVIDERS

## CUISIO TRANSLUCENT DIVIDERS

*Innovation  
begins with versatility*

Cuisio introduces a system of transparent dividers, offering versatile and modular organization for utensils across various drawer types and sizes.



Translucent white



Graphite translucent



- + The translucent finish lets you see through to the drawer.
- + Enjoy practicality with dishwasher-safe containers.
- + With no width restrictions, seamlessly combine all Cuisio dividers using the aluminum profile for versatile arrangements.
- + Enhance drawer aesthetics with the included side finishing profile (F), providing a polished appearance.
- + Aluminum profiles hold containers in place and add a stylish touch to your storage space.
- + Opt for an aluminium finish for profiles, translucent white for bins, and stainless finish for grey graphite bins.
- + Ensure safe storage of knives with knife holders (E).
- + Each divider includes a side compensation joint for precise fitting.



A 300

B 400

C 450

D 500



E Knife holder 3 15/16" and 5 29/32" (100 and 150mm) For use with dividers B, C or D.



F Lateral finishing profile to be ordered separately if your divider is positioned in the center of the drawer (two sides visible). If only one side is visible, one profile is already included per divider.



Interior depth:  
18 5/8" (473 mm)



Fig.	Code	Description	Min. interior width	Notes	Finish
A	225011	300 divider	8 1/16" (205 mm)	Knife block not compatible	White translucent
A	2250905	300 divider	8 1/16" (205 mm)	Knife block not compatible	Graphite translucent
B	225111	400 divider	12" (305 mm)	Suitable for 100 mm knife inserts	White translucent
B	2251905	400 divider	12" (305 mm)	Suitable for 100 mm knife inserts	Graphite translucent
C	225211	450 divider	14" (355 mm)	Suitable for 50 mm knife inserts	White translucent
C	2252905	450 divider	14" (355 mm)	Suitable for 150 mm knife inserts	Graphite translucent
D	225311	500 divider	16" (405 mm)	Suitable for 100 mm knife inserts	White translucent
D	2253905	500 divider	16" (405 mm)	Suitable for 100 mm knife inserts	Graphite translucent
E	2051100	Knife block 100	3 15/16" (100 mm)	Works with Fig. B and Fig. D dividers	Light grey
E	2052100	Knife block 150	5 29/32" (150 mm)	Works with Fig. C dividers	Light grey
F	205811	Lateral finish		Reversible (left or right)	White translucent
F	2058905	Lateral finish		Reversible (left or right)	Graphite translucent





## The perfect deep drawer organization solutions



- + Perfect for efficient organization of dishes, dry goods, and assorted containers.
- + Tailored for deep drawers with a minimum internal height of 5" (128 mm).
- + One model accommodates various sizes.
- + Adjustable in width and depth, ranging from 9 9/32" to 15 1/4" (236 to 386 mm).
- + Stylish grey finish complements many drawer interiors, featuring dark grey corners and a light center.
- + *Cuisio Flex* ensures a quiet experience with its anti-slip pads, preventing items from shifting when opening or closing the drawer.
- + Conveniently packaged as a set of two.
- + No assembly required for *Cuisio Flex*; simply fit it to the bottom of the drawer once the dimensions are adjusted to your preference.



*Cuisio Flex can also be used on your countertop to organize your spices or other seasonings.*

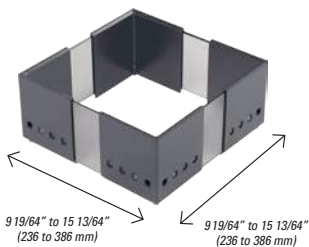

Tableware



Miscellaneous storage



Miscellaneous storage

Code	Description	Product dimensions (W x D x H) Width	Depth	Height
225011	Set of 2 organizers, dark grey	9 9/32" to 15 1/4" (236 to 386 mm)	9 9/32" to 15 1/4" (236 to 386 mm)	min. 5" (min. 128 mm)



STORAGE



PREPARATION



COOKING

## DRAWERS AND DIVIDERS

CONNECT 2.0  
DRAWER DIVIDERS

Configuration with 2 sets (A)

*Customize  
drawer interiors  
to your taste*

The *Connect 2.0* system offers pre-designed modular divider sets that seamlessly adapt to accommodate different drawer widths.

Its sleek, linear wall design maximizes storage efficiency, while components effortlessly interconnect with discreet clips that become invisible once assembled.



- + This system is designed for metal drawers with a nominal length (NL) of 19 11/16" or 21 22/32" (500 or 550 mm), such as *Optimiz-R*, *908*, *Legrabox*, *Antaro*, or equivalent models.
- + These assemblies smoothly install in metal drawers without requiring recutting and are compatible with other drawer types.
- + With limitless width possibilities, sets can be combined to suit your needs.
- + Achieve a flawless, personalized finish by using a protective mat (sold separately) at the drawer's bottom. Richelieu offers a wide selection of protective mats for your convenience.



Fig.	Code	Description	Finish	Product dimensions (W x D x H)
A	228892910	Set A for drawers Min. depth of 18 5/8" (473 mm)	Dark grey	10 13/16" x 18 5/8" x 2" (275 x 473 x 50 mm)
A	228891910	Set A for drawers Min. depth of 20 5/8" (523 mm)	Dark grey	10 13/16" x 20 5/8" x 2" (275 x 523 x 50 mm)
B	229945910	Set B for drawers Min. depth of 18 5/8" (473 mm)	Dark grey	18 3/4" x 18 5/8" x 2" (475 x 473 x 50 mm)
B	229943910	Set B for drawers Min. depth of 20 5/8" (523 mm)	Dark grey	18 3/4" x 20 5/8" x 2" (475 x 523 x 50 mm)
C*	229919910	Complementary set	Dark grey	17 3/4" x 16 3/4" x 2 3/8" (450 x 400 x 60 mm)
D*	229921910	Complementary set	Dark grey	16 3/4" x 17 3/4" x 2 3/8" (400 x 450 x 60 mm)
E	299156910	Non-slip mat	Dark grey	59" x 23 5/8" (1,500 mm x 600 mm)
F	Deco Mat	See page 27	Several	43 5/16" x 23 5/8" (1,100 x 600 mm)

\* Set C or D to be used in combination with set A or B.  
Works for both depths.



E Rigid mat, dark grey, 299156910



F Thick, soft Deco mats in several colors



STORAGE



PREPARATION



COOKING

**Configuration examples**



1 set (A)



1 set (B)



1 set (A) + 1 set (C)



1 set (A) + 1 set (D)



For interior widths from 10 13/16" (275 mm) or more. For interior depths of 18 5/8" or 20 5/8" (473 or 523 mm).



Min. width 18 23/32" (475 mm). Depth 18 5/8" or 20 5/8" (473 or 523 mm), uncut.

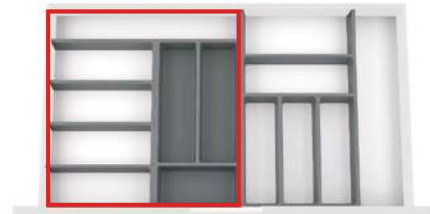

SET C + SET A

Min width 28 1/2" (725 mm). Depth of 18 5/8" or 20 5/8" (473 and 523 mm), uncut.

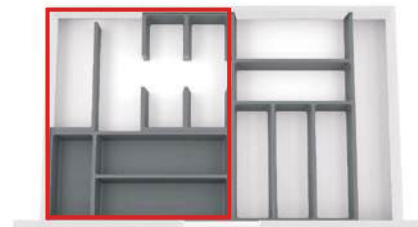

SET D + SET A

Min. width 26 9/16" (675 mm). Depth of 18 5/8" or 20 5/8" (473 or 523 mm), uncut.



For internal drawer widths of 10 13/16" (275 mm) and more, several configurations are available on [richelieu.com](http://richelieu.com)

Drawer depth required: metal drawer, no cutting required. For all other drawers, dividers can be cut to depths from 16 3/4" to 20 5/8" (400 to 523 mm).



**A** Cutlery divider



**B** Multi-purpose dividers



**C** Dividers for spice containers

## Versatile solutions for various drawer widths

The *Classico* product line presents an extensive selection of molded drawer dividers catering to various needs, from cutlery and utensils to spice containers and more, ensuring a solution for every drawer width.



- + Perfect for internal drawer widths ranging from 7 7/8" (200 mm) to 46 1/2" (1,180 mm).
- + Every divider is customizable in width and depth, ensuring a precise fit within your drawer.
- + With a height of 2" (50 mm), each divider fits into any standard drawer.
- + Crafted from high-quality polystyrene.
- + The products are available in two trendy finishes, white or dark grey.
- + Each spice divider can accommodate containers up to 4" (102 mm) high.



For a clean cut, use a ruler to mark a straight line with a utility knife, ensuring multiple passes over the line for precision. Then, fold along the cut line to remove excess material, and repeat the process for any additional sides if needed.

Fig.	White	Dark grey	Drawer int. width Minimum – maximum	Drawer int. depth Minimum – maximum
<b>A</b>	8200300030	8200300910	7 7/8" to 11 3/4" (200 to 300 mm)	18 1/2" to 21 1/4" (470 to 540 mm)
<b>A</b>	8300350030	8300350910	11 3/4" to 13 3/4" (300 to 350 mm)	18 1/2" to 21 1/4" (470 to 540 mm)
<b>A</b>	8350400030	8350400910	13 3/4" to 15 3/4" (350 to 400 mm)	18 1/2" to 21 1/4" (470 to 540 mm)
<b>A</b>	8400450030	8400450910	15 3/4" to 17 3/4" (400 to 450 mm)	18 1/2" to 21 1/4" (470 to 540 mm)
<b>A</b>	8450500030	8450500910	17 3/4" to 19 5/8" (450 to 500 mm)	18 1/2" to 21 1/4" (470 to 540 mm)
<b>A</b>	8500580030	8500580910	19 5/8" to 22 7/8" (500 to 580 mm)	18 1/2" to 21 5/8" (470 to 550 mm)
<b>A</b>	8600680030	8600680910	23 5/8" to 26 3/4" (600 to 680 mm)	18 1/2" to 21 5/8" (470 to 550 mm)
<b>A</b>	8700780030	8700780910	27 1/2" to 30 3/4" (700 to 780 mm)	18 1/2" to 21 5/8" (470 to 550 mm)
<b>A</b>	8800880030	8800880910	31 1/2" to 34 5/8" (800 to 880 mm)	18 1/2" to 21 5/8" (470 to 550 mm)
<b>A</b>	8900980030	8900980910	34 5/8" to 38 5/8" (900 to 980 mm)	18 1/2" to 21 5/8" (470 to 550 mm)
<b>A</b>	811001180030	811001180910	43 1/4" to 46 1/2" (1,100 to 1,180 mm)	18 1/2" to 21 5/8" (470 to 550 mm)
<b>B</b>	8290400030	8290400910	11 3/8" to 15 3/4" (290 to 400 mm)	17 15/16" to 21 1/4" (455 to 540 mm)
<b>B</b>	8390500030	8390500910	15 3/8" to 19 5/8" (390 to 500 mm)	17 15/16" to 21 1/4" (455 to 540 mm)
<b>B</b>	8490580030	8490580910	19 1/4" to 22 7/8" (490 to 580 mm)	17 15/16" to 21 1/4" (455 to 540 mm)
<b>C</b>	9300350030	9300350910	11 3/4" to 13 3/4" (300 to 350 mm)	17 5/16" to 20 1/2" (440 to 520 mm)
<b>C</b>	9360400030	9360400910	14 1/8" to 15 3/4" (360 to 400 mm)	17 5/16" to 20 1/2" (440 to 520 mm)
<b>C</b>	9400450030	9400450910	15 3/4" to 17 3/4" (400 to 450 mm)	17 5/16" to 20 1/2" (440 to 520 mm)
<b>C</b>	9500550030	9500550910	19 5/8" to 21 5/8" (500 to 550 mm)	17 5/16" to 20 1/2" (440 to 520 mm)



STORAGE



PREPARATION



COOKING

## Simplicity meets versatility

*Separado* offers a selection of three primary divider models (cutlery, multifunctional, or spice) designed for individual or combined use within a drawer.

The main feature of these dividers is that they are closed on both sides, allowing them to fit drawers with an internal width of 12" (305 mm) or more.



- + The finish is easy to care for.
- + Additional accessories:
  - Two inserts (**D**: knives ; **E**: spices) for multifunctional divider **C** ;
  - One divider **F** for multifunctional divider **C**.
- + Features a trendy dark grey finish.
- + Herb and spice divider **B** accommodates containers up to 5 1/4" (133 mm) in height.
- + Ultra-easy installation for metal drawers with a nominal length of 19 11/16" or 21 21/32" (500 or 550 mm), no cutting required, just place the divider in the bottom of the drawer.
- + Can be cut to ideal depth for other drawer types.
- + The side panels are very slim, which considerably increases the available storage space.



Pair one or multiple *Separado* modules with a non-slip mat to create additional storage compartments in between them.

Drawer depth required: for metal drawers, no cutting necessary.

For all other drawers, dividers can be trimmed in depth:  
 - 473mm (18 5/8") can be trimmed up to 462mm (18 3/16").  
 - 523 mm (20 5/8") can be trimmed up to 485mm (29 1/8").



**A** Cutlery divider



**B** Spice divider



**C** Multifunctional divider  
**F** Divider insert



Multifunctional divider (C)



Knife-holder insert (D)



Spice insert (E)



Separator for multifunctional divider (F)



**C + D**



**C + E**

Fig.	Code	Description	Product dimensions (W x D)
<b>A</b>	5050910	Cutlery tray <i>Separado</i> 500	11 3/4" x 18 5/8" (300 mm x 473 mm)
<b>A</b>	5055910	Cutlery tray <i>Separado</i> 550	11 3/4" x 20 5/8" (300 mm x 523 mm)
<b>B</b>	5150910	Spice tray <i>Separado</i> 500	11 3/4" x 18 5/8" (300 mm x 473 mm)
<b>B</b>	5155910	Spice tray <i>Separado</i> 550	11 3/4" x 20 5/8" (300 mm x 523 mm)
<b>C</b>	5250910	Multipurpose tray <i>Separado</i> 500	11 3/4" x 18 5/8" (300 mm x 473 mm)
<b>C</b>	5255910	Multipurpose tray <i>Separado</i> 550	11 3/4" x 20 5/8" (300 mm x 523 mm)
<b>D</b>	5240910	Knife holder insert <i>Separado</i>	6 17/32" x 17" (166 mm x 433 mm)
<b>E</b>	5241910	Spice insert <i>Separado</i>	6 17/32" x 17" (166 mm x 433 mm)
<b>F</b>	5242910	Divider insert for multipurpose tray <i>Separado</i>	6 23/32" (171 mm)



Product height is  
1 15/16" (49 mm).



STORAGE PREPARATION COOKING

## DRAWERS AND DIVIDERS

## ORGANIZ-R DRAWER SYSTEM



Richelieu's *Organiz-R* storage systems are the perfect solution for organizing drawers.



- + Complete set or separate components.
- + Durable steel.
- + Dishwasher-safe stainless steel bins.
- + Multiple configurations are achievable with a diverse range of sizes and finishes (including stainless steel and charcoal grey).
- + Compatible with all traditional metal and wooden drawers.



Four key components:

### 1 Side panels



#### 808SP XX

*Organiz-R* side panels are available in two lengths and two finishes. These panels are modular and can be linked together using *Organiz-R* end connectors.

### 2 End connectors



#### 808EC XX

These connectors are designed to assemble side panels to offer infinite possibilities for drawer storage configurations.

### 3 Removable cross dividers



#### 808CD XX

To install in the holes between the side panels, these dividers effectively partition the *Organiz-R* every 1 15/32" (37 mm).

### 4 Trays



#### 808TR XX

Versatile and durable, these trays are perfect for effortless drawer organization.



STORAGE



PREPARATION



COOKING

**Organiz-R cutlery set (A)**

Each set includes:

- Two side panels
- Two end fittings
- One cross divider
- Five trays



A

**Organiz-R utensil set (B)**

Each set includes:

- Two side panels
- Two end fittings
- One cross divider



B



B



B



Discover the *Organiz-R* range of pre-assembled starter sets, offering ready-made solutions for tidy, smart storage of cutlery, utensils, spices, and beyond!

**Cutlery sets**

	Anthracite grey	Stainless steel	Length before assembly	Height	Width after assembly
A	808CKIT450100	808CKIT450170	18" (450 mm)	2 9/32" (58 mm)	10 7/8" (276 mm)
A	808CKIT500100	808CKIT500170	20" (500 mm)	2 9/32" (58 mm)	10 7/8" (276 mm)
A	808CKIT550100	808CKIT550170	22" (550 mm)	2 9/32" (58 mm)	10 7/8" (276 mm)



**Narrow**

	Anthracite grey	Stainless steel	Length	Height	Width
B	808NKIT450100	808NKIT450170	18" (450 mm)	2 9/32" (58 mm)	3 15/16" (100 mm)
B	808NKIT500100	808NKIT500170	20" (500 mm)	2 9/32" (58 mm)	3 15/16" (100 mm)
B	808NKIT550100	808NKIT550170	22" (550 mm)	2 9/32" (58 mm)	3 15/16" (100 mm)

**Medium**

	Anthracite grey	Stainless steel	Length	Height	Width
B	808MKIT450100	808MKIT450170	18" (450 mm)	2 9/32" (58 mm)	7 13/32" (188 mm)
B	808MKIT500100	808MKIT500170	20" (500 mm)	2 9/32" (58 mm)	7 13/32" (188 mm)
B	808MKIT550100	808MKIT550170	22" (550 mm)	2 9/32" (58 mm)	7 13/32" (188 mm)

**Large**

	Anthracite grey	Stainless steel	Length	Height	Width
B	808WKIT450100	808WKIT450170	18" (450 mm)	2 9/32" (58 mm)	10 7/8" (276 mm)
B	808WKIT500100	808WKIT500170	20" (500 mm)	2 9/32" (58 mm)	10 7/8" (276 mm)
B	808WKIT550100	808WKIT550170	22" (550 mm)	2 9/32" (58 mm)	10 7/8" (276 mm)

**Organiz-R mounting bracket (808BR2G)**

The package includes two brackets and two screws designed to firmly secure and stabilize the *Organiz-R* storage system at the bottom of the drawer. In some cases, drawers may have non-standard lengths, causing the storage system to shift when opened or closed. This simple and easy-to-install bracket provides the ideal solution to this problem.



STORAGE

PREPARATION

COOKING



## Deep-drawer solutions

*Organiz-R* is the ideal solution to optimize and organize deep metal drawer storage. Assess your needs and select the storage solutions that align with your items and available space. Well-organized deep drawers can help improve efficiency and reduce clutter.

### Four key components:

#### 1 Horizontal rails



#### 808HR XX

The *Organiz-R* horizontal aluminum rails can easily be cut to fit any size. With cross rail connectors, these rails can be mounted onto the *Optimiz-R* drawer wall system or a gallery side rail.

#### 2 Cross rail connectors



#### 808AD XX

This clever *Organiz-R* transverse rod connector is intended to fit with both the *Optimiz-R* drawer side system and side rack rails. The cushion inside the connector has been carefully designed to offer versatility, allowing for various configurations based on your specific needs.



#### 3 Lateral dividers



#### 808LS XX

The *Organiz-R* lateral dividers discretely segment your storage space. Their compact design allows to add as many as you need, making them perfect for storing bottles, containers, and lids.

#### 4 Square partition dividers



#### 808RS XX

The *Organiz-R* square partition offers ample support surface, enhancing the horizontal rail system by providing separation and segmenting your storage space. It is particularly suited for accommodating larger items, ensuring pots and pans remain securely in place.

Available in three finishes:

- Anthracite (100)
- White (30)
- Black (900)





STORAGE



PREPARATION



COOKING



Product shown: utensil dividers



- + Compatible with all drawer types available in the market.
- + Can be cut to desired width and depth.
- + Constructed from durable polystyrene material.
- + Available in three finishes: classic white, silver-grey, and dark grey.
- + Cutlery divider: Designed for convenient food storage and preparation.
- + Utensil divider: Ideal for organizing preparation and cooking areas.



A Cutlery divider, white

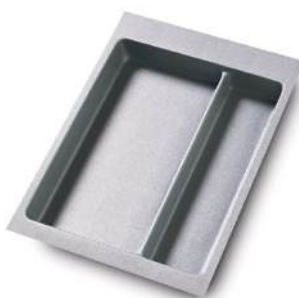

B Utensil divider, silver grey



C Cutlery and utensil divider for wide drawers, dark grey

Fig.	Code	Description	Finish	Int. dimensions required for drawers (W x D x H)		
A	1030-30,100, 910	Cutlery dividers	White, grey, dark grey	7 3/4" to 9 3/4" (197 to 248 mm)	17" to 21 1/2" (432 to 546 mm)	2" (50 mm)
A	1035-30,100, 910	Cutlery dividers	White, grey, dark grey	9 1/2" to 11 3/4" (241 to 298 mm)	17" to 21 1/2" (432 to 546 mm)	2" (50 mm)
A	1040-30,100, 910	Cutlery dividers	White, grey, dark grey	11 1/2" to 13 3/4" (292 to 349 mm)	17" to 21 1/2" (432 to 546 mm)	2" (50 mm)
A	1045-30,100, 910	Cutlery dividers	White, grey, dark grey	13 1/2" to 15 3/4" (343 to 400 mm)	17" to 21 1/2" (432 to 546 mm)	2" (50 mm)
A	1050-30,100, 910	Cutlery dividers	White, grey, dark grey	15 1/2" to 17 3/4" (394 to 451 mm)	17" to 21 1/2" (432 to 546 mm)	2" (50 mm)
A	1055-30,100, 910	Cutlery dividers	White, grey, dark grey	17 3/4" to 19 3/4" (451 to 502 mm)	17" to 21 1/2" (432 to 546 mm)	2" (50 mm)
A	1060-30,100,, 910	Cutlery dividers	White, grey, dark grey	19 1/2" to 21 3/4" (495 to 552 mm)	17" to 21 1/2" (432 to 546 mm)	2" (50 mm)
B	1140-30,100, 910	Cutlery dividers	White, grey, dark grey	11 3/4" to 13 3/4" (298 to 349 mm)	17" to 21 1/2" (432 to 546 mm)	2" (50 mm)
B	1145-30,100, 910	Cutlery dividers	White, grey, dark grey	13 3/4" to 15 3/4" (349 to 400 mm)	17" to 21 1/2" (432 to 546 mm)	2" (50 mm)
B	1150-30,100, 910	Cutlery dividers	White, grey, dark grey	15 1/4" to 17 3/4" (387 to 451 mm)	17" to 21 1/2" (432 to 546 mm)	2" (50 mm)
B	1155-30,100, 910	Cutlery dividers	White, grey, dark grey	17 1/4" to 19 3/4" (439 to 502 mm)	17" to 21 1/2" (432 to 546 mm)	2" (50 mm)
B	1160-30,100, 910	Cutlery dividers	White, grey, dark grey	19 1/2" to 21 3/4" (495 to 552 mm)	17" to 21 1/2" (432 to 546 mm)	2" (50 mm)
C	0075-030, 910	Dividers for large drawers	White, dark grey	21 1/4" to 26" (540 to 660 mm)	18 3/4" to 21 1/4" (475 to 540 mm)	2" (50 mm)
C	0085- 030, 910	Dividers for large drawers	White, dark grey	24 3/8" to 29 1/8" (620 to 740 mm)	18 3/4" to 21 1/4" (475 to 540 mm)	2" (50 mm)
C	0095-030, 910	Dividers for large drawers	White, dark grey	27 3/8" to 32 1/8" (695 to 815 mm)	18 3/4" to 21 1/4" (475 to 540 mm)	2" (50 mm)



STORAGE



PREPARATION



COOKING

## DRAWERS AND DIVIDERS

## SPICE DIVIDERS



A Cut-to-size spice divider



B Spice divider



C Grooved cut-to-size spice divider



D Cut-to-size spice divider in natural wood, maple finish

## Spice up your kitchen!

Wave-shaped design makes it easy to spot all the herbs and spices at a glance.



### A-B-C

- + Easy-care finish.
- + Can be trimmed as needed to accommodate different drawer dimensions.
- + Three finishes available: white, silver grey, and dark grey.



A White



A Silver grey



A Dark grey



### D

- + Natural wood with maple finish.
- + Easy to cut-to-size.



Fig.	Code	Description	Finish	Int. dimensions required for drawers (W x D x H)		
A	5021-30, 100, 910	Cut-to-size spice dividers	White, grey, dark grey	52" cut-to-size (1,321 mm cut-to-size)	17 1/2" to 21 1/2" (445 to 546 mm)	2" (50 mm)
B	1340-30, 100, 910	Spice dividers	White, grey, dark grey	11 1/4" to 13 3/4" (286 to 349 mm)	16" to 21 1/2" (406 to 546 mm)	2" (50 mm)
B	1345-30, 100, 910	Spice dividers	White, grey, dark grey	13 1/2" to 15 3/4" (343 to 400 mm)	16" to 21 1/2" (406 to 546 mm)	2" (50 mm)
B	1350-30, 100, 910	Spice dividers	White, grey, dark grey	15 1/4" to 17 3/4" (387 to 451 mm)	16" to 21 1/2" (406 to 546 mm)	2" (50 mm)
C	5022-30, 100, 910	Cut-to-size spice dividers	White, grey, dark grey	52" cut-to-size (1,321 mm cut-to-size)	17 1/2" to 21 1/2" (445 to 546 mm)	2" (50 mm)
D	9522261	Cut-to-size spice divider	Natural maple	22 1/8" cut-to-size (562 mm cut-to-size)	17 1/2" to 19 1/2" (445 to 495 mm)	2" (50 mm)
D	9560261	Cut-to-size spice divider	Natural maple	60" cut-to-size (1,524 mm cut-to-size)	17 1/2" to 20 3/4" (445 to 527 mm)	2" (50 mm)

## SINGLE AND DOUBLE CUTLERY AND UTENSIL DIVIDERS

## DRAWERS AND DIVIDERS



STORAGE



PREPARATION



COOKING



**A** Single dividers



**B** Double-tiered dividers



**C** Universal drawer profile set. The second photo shows the product assembled in a drawer (drawer not included).



**B**

- + Double dividers significantly increase storage capacity with the inclusion of a top divider.
- + Please be advised: drawers should have an internal height of no less than 3 3/8" (85 mm).
- + These dividers can be cut to any desired size.



**B** White



**B** Silver grey



**C**

- + The set comprises 6 L sections and one flat section, allowing for customizable arrangements as needed.
- + Easy-to-cut to length.
- + Numerous potential configurations.

Fig.	Code	Description	Finish	Int. dimensions required for drawers (W x D x H)		
<b>A</b>	05305130	Single cutlery dividers	White	11 7/8" to 15 11/16" (301 to 399 mm)	17 1/4" to 19 1/2" (437 to 496 mm)	2" (50 mm)
<b>A</b>	05305230	Single cutlery dividers	White	15 3/4" to 19 11/16" (401 to 499 mm)	17 1/4" to 19 1/2" (437 to 496 mm)	2" (50 mm)
<b>A</b>	05305330	Single cutlery dividers	White	19 3/4" to 22" (501 to 559 mm)	17 1/4" to 19 1/2" (437 to 496 mm)	2" (50 mm)
<b>B</b>	4030, 41100	Double-tiered dividers	White, grey	11 1/2" to 13 3/4" (292 to 349 mm)	18" to 21 1/2" (457 to 546 mm)	3 3/8" (85 mm)
<b>B</b>	45-30, 100	Double-tiered dividers	White, grey	13 3/4" to 15 3/4" (349 to 400 mm)	18" to 21 1/2" (457 to 546 mm)	3 3/8" (85 mm)
<b>B</b>	55-30, 100	Double-tiered dividers	White, grey	15 1/2" to 17 3/4" (394 to 451 mm)	18" to 21 1/2" (457 to 546 mm)	3 3/8" (85 mm)
<b>B</b>	60-30, 100	Double-tiered dividers	White, grey	19 1/2" to 21 3/4" (495 to 552 mm)	18" to 21 1/2" (457 to 546 mm)	3 3/8" (85 mm)
<b>C</b>	0491261	Set of utensil dividers	Birch	19 3/4" (502 mm)		
<b>C</b>	0495261	Set of utensil dividers	Birch	60" (1,520 mm)		



STORAGE PREPARATION COOKING

## DRAWERS AND DIVIDERS

## SOFT LARGE-FORMAT ANTI-SLIP MATS AND *ECONO* MATS

*Protect and enhance your drawers*



- + Soft non-slip mats hold utensils and modular dividers in place.
- + Ideal for protecting drawer bottoms from scratches.
- + Easy to clean and waterproof.
- + Available in a various range of finishes, patterns and sizes to suit all drawer types.
- + Compatible with both wood and metal drawers.
- + Easy to recut (using a utility knife) to desired dimensions.



**A** Large-format, translucent soft mat

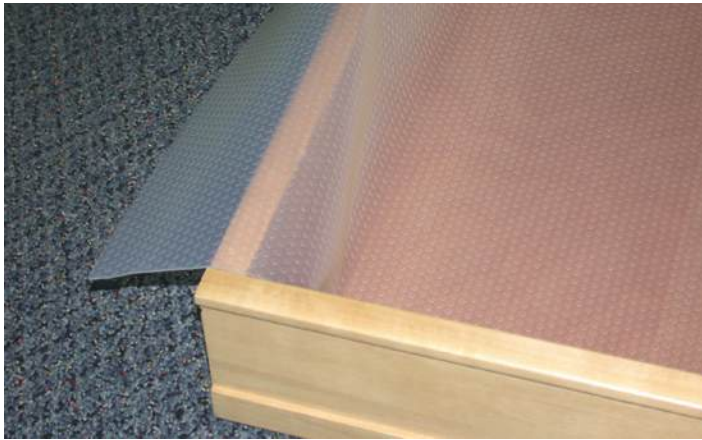

All our soft mats can be easily recut using a utility knife and a ruler. Once recut, the mat can accept more than one drawer.

We recommend installing a non-slip mat in all your drawers.



**B**



**C** Econo soft mat, silver grey

Fig.	Code	Description	Product dimensions (W x D)	Finish
<b>A</b>	4711015011	Soft large-format anti-slip mats	59" x 43 1/4" (1,500 mm x 1,100 mm)	Translucent
<b>B</b>	47110150100	Soft large-format anti-slip mats	59" x 43 1/4" (1,500 mm x 1,100 mm)	Grey
<b>C</b>	61100100	<i>Econo</i> soft mat	43 1/4" x 23 5/8" (1,100 mm x 600 mm)	Grey



STORAGE



PREPARATION



COOKING



## An innovative system

Introducing *Riverso*, a revolutionary bidirectional drawer system enabling drawers to open from either side of the cabinet. The ideal solution for any island configuration!



- + Complete access to every drawer's content with the full-extension drawer slide.
- + Smooth, silent closing.
- + Elegant concealed mounting.
- + Optional handle free opening.
- + Allows to interchange items between drawers located on either side of the cabinet or between different rooms.



Code	Length
200248104	21" (530 mm)
200248204	24" (610 mm)
200248304	30" (760 mm)

### Optional accessories

#### 1 Press-to-open mechanism

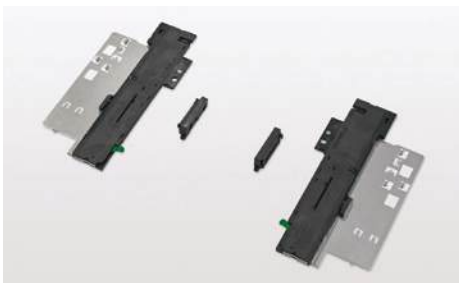

**200248400**

The *Riverso* system is compatible with a push-open mechanism for a handleless look.

#### 2 Set of reinforcement brackets



**200266204**

Reinforcement brackets provide additional strength for 6" (160 mm) high facades.

#### 3 Synchronization rod



**200251420**

Particularly useful for wide drawers, and highly recommended when using press-to-open mechanism to increase the contact surface.



Cooko

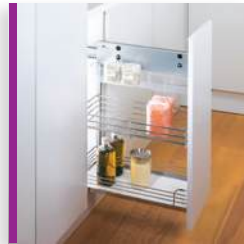

*Slim*



*BPO II*



*Narrow sliding shelves*



*Fiore*

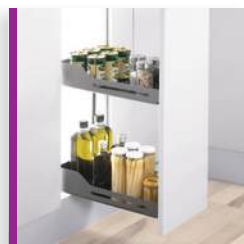

*Snello*

## *No more searching through the base cabinets anymore*

Base cabinets are often the most plentiful in your kitchen, so why not make them practical and functional. Pull-out storage and shelf systems allow total access to the cabinet contents in a single movement.

<i>Comfort II</i> pull-out shelves and anti-slip shelves	44
<i>Slim</i> pull-out system	46
<i>BPO II</i> pull-out system	48
Pull-out systems for narrow widths	51
<i>Fiore</i> pull-out storage	52
<i>Cooko</i> and <i>Vario</i> pull-out storage systems	53
<i>Snello</i> pull-out storage	54
Adjustable pull-out storage shelf	55
Pull-out storage systems and accessories	56



FOOD STORAGE



STORAGE



CLEANING



PREPARATION

## BASE CABINETS

## SLIDING SHELVES IN CHROME WIRE AND COMFORT II NON-SLIP SHELVES

### Uncompromising comfort for base cabinets

The *Comfort II* system, featuring height-adjustable shelves/baskets, perfectly adjusts to meet specific kitchen storage needs. A wide range of shelves/baskets is available to store various types of ingredients such as oils, spices, vinegars, dried foods, and more. The idea is simple: effortlessly bring the entire content of the shelves/baskets to the front with a single hand gesture.



- + Full-extension pull-out frame allows contents to be viewed and accessed at a glance.
- + Available in a range of heights and widths.
- + Choose between right- or left-hand opening.
- + Designed with a heavy-duty silver-grey metal frame, featuring a *Softstopp* shock absorber for smooth closing.
- + Select from two shelf/basket models:
  - A:** Arena, offering stability and sophistication, equipped with a non-slip melamine lining and a metal contour to securely hold contents in place.
  - B:** Chrome wire, providing transparency and elegance.
- + Load capacity of 52 lb (24 kg).

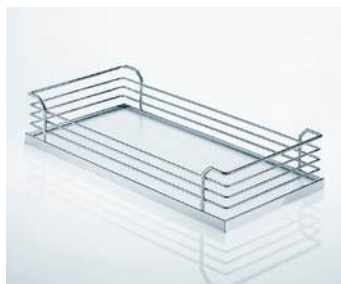

**A** Arena shelf in silver-grey finish non-slip melamine with chrome contour

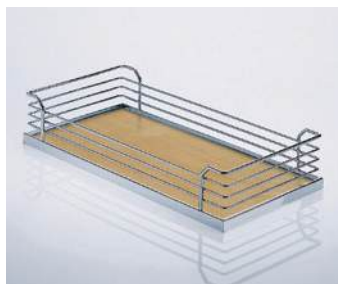

**A** Arena shelf in maple-finish non-slip melamine with chrome contour



**B** Basket in thick chrome wire



**C** Arena non-slip shelf in anthracite finish with flat "Style" anthracite contour

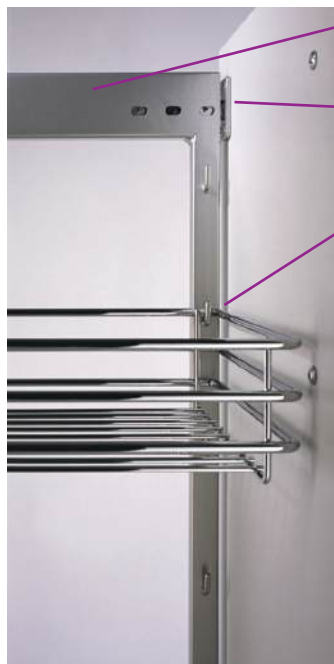

Frame: equipped with *Softstopp* system.

Door brackets: quick assembly with clip-on connectors

Frame with hooks for sturdy shelf/basket mounting.





# SLIDING SHELVES IN CHROME WIRE AND COMFORT II NON-SLIP SHELVES

## BASE CABINETS



### EASY TO ORDER

1

Order a frame according to available height.

2

Order the suggested number of shelves/baskets according to the minimum interior width available and the type of shelf/basket.

3

Order options.



Two mounting brackets included with frame



Mounting bracket

### 1 Order your frame (including runners and mounting brackets)



Minimum interior depth required  
19 1/8" (485 mm).

Access: Right-hand

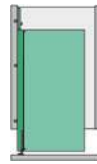

Left-hand



Min. int. height required	Right-hand access silver grey	Left-hand access silver grey	Right-hand access Anthracite	Left-hand access Anthracite	Suggested number of shelves/baskets
20 3/4" (526 mm)	607530100	607520100	607530906	607520906	2
25 3/4" (654 mm)	607570100	607560100	607570906	607560906	3

### 2 Order shelves/baskets



Min. int. width required	Arena shelves Grey/chrome	Arena shelves Maple/chrome	Arena shelves Anthracite/Anthracite with Style rail	Min. int. width required	Thick wire basket in chrome
5 3/4" (145 mm)	5140140100	5140140150	5140906906	5 3/4" (145 mm)	5140140
7 3/4" (195 mm)	5141140100	5141140150	5141906906	7 3/4" (195 mm)	5141140
10 3/8" (263 mm)	5142140100	5142140150	5142906906	9 5/8" (245 mm)	5142140
13" (330 mm)	5143140100	5143140150		14" (355 mm)	5143140
14" (355 mm)			5143906906		

### 3 Order options



Selection of spacers for framed cabinet installations.

Fig.	Code	Description	Product dimensions (W x H x D)			Finish
			Width	Height	Depth	
C	455670910	Spacer	1" (25 mm)	2" (50 mm)	19 1/4" (489 mm)	Anthracite
C	455670100	Spacer	1" (25 mm)	2" (50 mm)	19 1/4" (489 mm)	Silver grey
C	458240100	Spacer	1/2" (12 mm)	2" (50 mm)	19 1/4" (489 mm)	Silver grey
D	60285012	Spacer	1" (25 mm)	2" (50 mm)	1" (25 mm)	White
E	252770100	Spice tray	5 7/16" (138 mm)	3 2/16" (80 mm)	18 7/8" (480 mm)	Silver grey



FOOD STORAGE STORAGE PREPARATION

BASE CABINETS

SLIM  
PULL-OUT SYSTEM



Product shown with matching Arena chrome shelves and Slim shelf



Narrow shelf #29174810 specific to Slim, made of sturdy polycarbonate, provides a storage solution for smaller spaces.

*Universal,  
reversible and versatile  
pull-out system*



- + Perfect for storing groceries, including bottles, herbs, and spices.
- + Reversible design allows for left or right-hand opening.
- + Frame finished in silver grey.
- + Sliding system available in two different heights.
- + Solid door installation, including door brackets.
- + Maximizes space utilization, suitable for frameless cabinets with an interior width ranging from 4 5/8" to 14" (118 to 357 mm).
- + Frames compatible with Arena shelves or chrome wire baskets, ensuring optimal storage in compact areas.
- + Can also be used with robust polycarbonate baskets specifically designed for Slim #29174810.
- + Features a connection system between frame and runner for easy assembly.
- + Full-extension slide with a dampened closing mechanism.
- + Side- and bottom-mounted slides ensure durability and stability.
- + Load capacity of 66 lb (30 kg).



**A Slim set**  
Includes: 1 reversible frame, 1 set of runners, 1 pair of door brackets

Fig.	Code	Description	Min. int. dimensions required (H x D)		Finish
			Height	Depth	
A	2912450100	Slim 485 reversible frame	19 1/8" (485 mm)	18 1/2" (480 mm)	Silver grey
A	2914680100	Slim 680 reversible frame	26 3/4" (680 mm)	18 1/2" (480 mm)	Silver grey

**Choice of baskets/shelves**

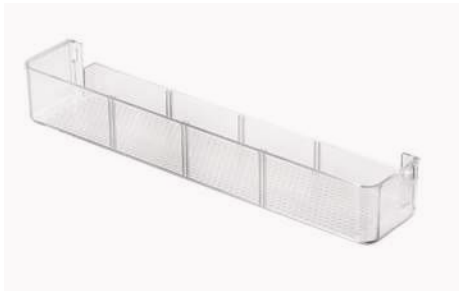

**B** Slim polycarbonate shelves



**C** Basket in thick chrome wire

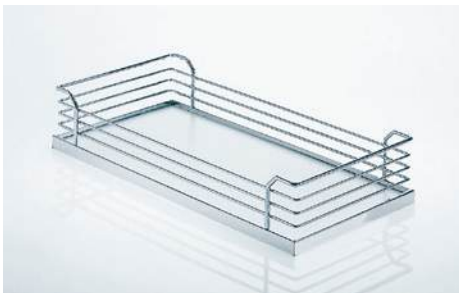

**D** Arena non-slip melamine shelf in silver grey finish with chrome contour

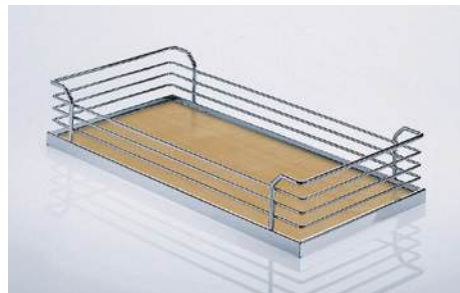

**D** Arena non-slip melamine shelf in maple finish with chrome contour



**E** Arena non-slip shelf in anthracite finish with flat contour anthracite "Style"

Fig.	Code	Description	Min. int. width	Finish
<b>B</b>	29174810	<i>Slim</i> shelf	4 5/8" (118 mm)	Transparent
<b>C</b>	5140140	Thick chrome wire basket	5 3/4" (147 mm)	Chrome
<b>C</b>	5141140	Thick chrome wire basket	7 3/4" (197 mm)	Chrome
<b>C</b>	5142140	Thick chrome wire basket	9 3/4" (247 mm)	Chrome
<b>C</b>	5143140	Thick chrome wire basket	14" (357 mm)	Chrome
<b>D</b>	5140140100	<i>Arena</i> shelves	5 3/4" (147 mm)	Grey/chrome
<b>D</b>	5141140100	<i>Arena</i> shelves	7 3/4" (197 mm)	Grey/chrome
<b>D</b>	5142140100	<i>Arena</i> shelves	10 7/16" (265 mm)	Grey/chrome
<b>D</b>	5143140100	<i>Arena</i> shelves	13 1/16" (332 mm)	Grey/chrome
<b>D</b>	5140140150	<i>Arena</i> shelves	5 3/4" (147 mm)	Maple/chrome
<b>D</b>	5141140150	<i>Arena</i> shelves	7 3/4" (197 mm)	Maple/chrome
<b>D</b>	5142140150	<i>Arena</i> shelves	10 7/16" (265 mm)	Maple/chrome
<b>D</b>	5143140150	<i>Arena</i> shelves	13 1/16" (332 mm)	Maple/chrome
<b>E</b>	5140906906	<i>Arena</i> shelves	5 3/4" (147 mm)	Anthracite/anthracite
<b>E</b>	5141906906	<i>Arena</i> shelves	7 3/4" (197 mm)	Anthracite/anthracite
<b>E</b>	5142906906	<i>Arena</i> shelves	10 7/16" (265 mm)	Anthracite/anthracite
<b>E</b>	5143906906	<i>Arena</i> shelves	14 1/16" (357 mm)	Anthracite/anthracite



FOOD STORAGE



STORAGE



CLEANING



PREPARATION

## BASE CABINETS

## BPO II PULL-OUT SYSTEM

*The base cabinet system that provides the utmost*

BPO II combines convenience with versatility. Pair shelves and accessories to craft a personalized storage solution. The central frame, positioned at the top and bottom of the cabinet, enables access from either side, while providing added stability. Optional accessories such as spice racks, cutting board racks, and baking trays allow complete customization of the base cabinets!



- + Narrow central frame for easy access from both sides. It optimizes the shelf width and increases the storage area.
- + Telescopic frame enables height adjustment up to 8" (203 mm).
- + Runners feature a soft-close mechanism for gentle closing.
- + Load capacity of 60 lb (27 kg).
- + Secures to both the top and bottom of the cabinet, ensuring impeccable stability.
- + Universal: shelves are compatible with our *Dispensa U.S.* sliding system for pantry cabinets.
- + Optimized: shelves have a depth of 22 1/16" (560 mm).
- + This series offers the widest range of widths.
- + Frame in silver grey finish.



### Minimum installation depth:

22 1/2" (571 mm)

### Min. installation height required:

2662100: 20 to 28" (508 to 711 mm)

2663100: 24 to 32" (610 to 813 mm)

### Minimum opening width required (A)

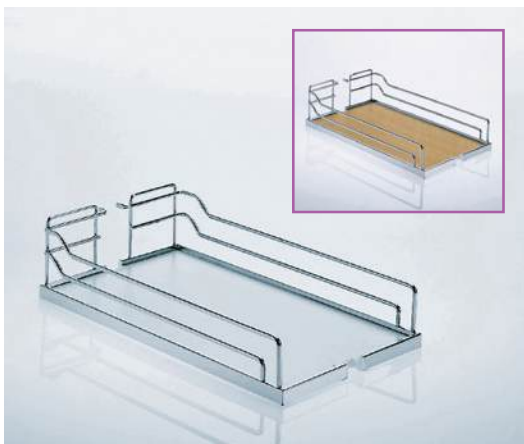

*Arena non-slip melamine shelf in silver grey or maple finish with chrome contour*

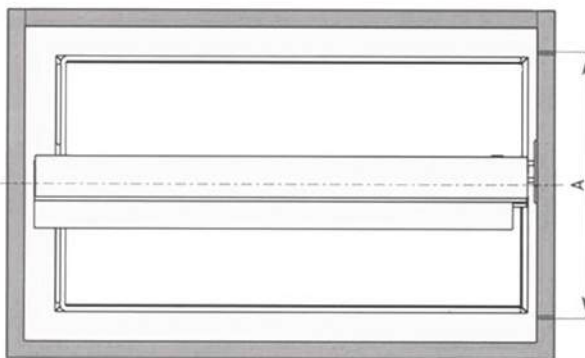

Framed cabinet

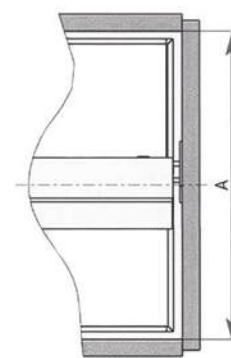

Frameless cabinet



Easy to order

**1 Order your frame**

Fig.	Code	Description	Dimensions (W x D x H)			Finish
			Width	Depth	Height	
A	2662100	BPO II base frame H: 20 to 28"	3 3/4" (95 mm)	22 1/2" (571 mm)	20" to 28" (508 to 711 mm)	Silver grey
A	2663100	BPO II frame H: 24 to 32"	3 3/4" (95 mm)	22 1/2" (571 mm)	24" to 32" (610 to 813 mm)	Silver grey

**2 Order your frame mounting options**

Fig.	Code	Description	Dimensions (W x D x H)			Finish
			Width	Depth	Height	
B	2647100	Large door brackets for BPO II	5 1/2" (140 mm)	3 1/2" (89 mm)	1 1/2" (38 mm)	Silver grey
C	4255100	Additional hook	4" (102 mm)			Silver grey
D	2760452G	Lateral bars	For int. width of 4 1/2" to 5" (114 to 127 mm)			Silver grey
D	2760752G	Lateral bars	For int. width of de 7 1/2" to 10 1/2" (191 to 267 mm)			Silver grey
D	2761352G	Lateral bars	For int. width of de 13 1/2" to 19 1/2" (343 to 495 mm)			Silver grey



A Frame in silver grey finish



B For door cabinets wider than 15" (381 mm), the BPO II wide door support is necessary. It is optional for cabinets narrower than 15" (381 mm). Replace bottom bracket only.



C Allows to add an extra hook for hanging another shelf or accessory when the frame is extended by 4" (102 mm).



D These side brackets are required for installation of the frame under a drawer. More details on [richelieu.com](http://richelieu.com)

**3 Order your set of two Arena shelves**

Grey/chrome	Maple/chrome	Min. opening width	Shelf dimensions (W x D x H)		
			Width	Depth	Height
33140100	33140150	4 1/2" (114 mm)	4" (102 mm)	20 3/8" (518 mm)	4 1/8" (105 mm)
24140100	24140150	5 1/2" (140 mm)	5" (127 mm)	20 3/8" (518 mm)	4 1/8" (105 mm)
34140100	34140150	7 1/2" (191 mm)	7" (178 mm)	20 3/8" (518 mm)	4 1/8" (105 mm)
25140100	25140150	8 1/2" (216 mm)	8" (203 mm)	20 3/8" (518 mm)	4 1/8" (105 mm)
35140100	35140150	10 1/2" (267 mm)	10" (254 mm)	20 3/8" (518 mm)	4 1/8" (105 mm)
26140100	26140150	11 1/2" (292 mm)	11" (279 mm)	20 3/8" (518 mm)	4 1/8" (105 mm)
36140100	36140150	13 1/2" (343 mm)	13" (330 mm)	20 3/8" (518 mm)	4 1/8" (105 mm)
27140100	27140150	14 1/2" (368 mm)	14" (356 mm)	20 3/8" (518 mm)	4 1/8" (105 mm)
37140100	37140150	16 1/2" (419 mm)	16" (406 mm)	20 3/8" (518 mm)	4 1/8" (105 mm)
28140100	28140150	17 1/2" (445 mm)	17" (432 mm)	20 3/8" (518 mm)	4 1/8" (105 mm)
38140100	38140150	19 1/2" (495 mm)	19" (483 mm)	20 3/8" (518 mm)	4 1/8" (105 mm)
39140100	39140150	20 1/2" (521 mm)	20" (508 mm)	20 3/8" (518 mm)	4 1/8" (105 mm)

**3 Order your metal shelves**

Code	Min. opening width (X)	Shelf dimensions (W x D x H)		
		Width	Depth	Height
25474100	3 7/8" (98 mm)	3 3/8" (86 mm)	20 3/8" (517 mm)	2" (50 mm)
25475100	4 1/2" (112 mm)	4" (102 mm)	20 3/8" (517 mm)	2" (50 mm)
25476100	5 1/2" (140 mm)	5" (127 mm)	20 3/8" (517 mm)	2" (50 mm)
25477100	7 1/2" (191 mm)	7" (178 mm)	20 3/8" (517 mm)	2" (50 mm)

Metal shelf in silver grey finish





FOOD STORAGE



STORAGE



CLEANING



PREPARATION

## BASE CABINETS

## BPO II PULL-OUT SYSTEM



**A** Tray holder

### Cutting board and baking tray holder

Transform your *BPO II* into a customizable storage solution tailored to your needs with a variety of accessories.

#### **A** Tray holder

Includes:  
2 wire metal dividers  
1 metal shelf  
**25556100**: 4 plastic clips  
**25557100**: 6 plastic clips  
**25558100**: 8 plastic clips

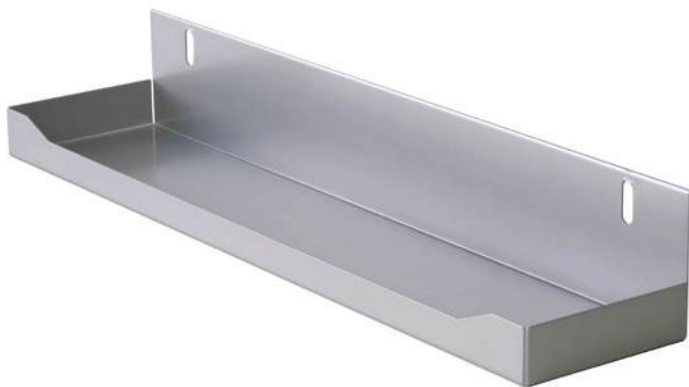

**B** Spice tray



### 4 Order other accessories instead of shelves

Fig.	Code	Description	Min. opening width	Product dimensions (W x D x H)		Height
				Width	Depth	
<b>A</b>	25556100	Tray holder 3 3/8"	3 7/8" (98 mm)	3 3/8" (86 mm)	20 3/8" (518 mm)	min. 8" (min. 203 mm)
<b>A</b>	25557100	Tray holder 5"	5 1/2" (140 mm)	5" (127 mm)	20 3/8" (518 mm)	min. 8" (min. 203 mm)
<b>A</b>	25558100	Tray holder 7"	7 1/2" (191 mm)	7" (178 mm)	20 3/8" (518 mm)	min. 8" (min. 203 mm)
<b>B</b>	25771100	Spice tray 4 1/2"*	10 1/2" (267 mm)*	4 1/2" (114 mm)	20 1/2" (521 mm)	1 1/2" (38 mm)



\* Minimum opening is designed for two spice trays, with one placed on each side (recommended).

# 15ER PULL-OUT SYSTEMS FOR NARROW CABINET WIDTHS

## BASE CABINETS



*For your 15ER*

Ideal for narrow cabinet in preparation, cooking or washing areas.



- + Mounted on the interior right side of the cabinet and on the door.
- + All models feature a shock-absorbing system for soft closing.
- + Towel rails (A) feature an anti-slip coating to keep towels and tea towels securely in place.
- + Shelf is fixed.
- + Perfect for 6" (150 mm) cabinets.
- + Tip: Ensure assembly prior to final cabinet installation.



**Cooking and preparation zone:**  
Spices, sauces, oils and vinegars



**Washing area:**  
Towels and cleaning products



**Cooking zone:**  
Baking trays



**A** 115399140  
Towel rack



**B** 115400140  
Sliding dish rack  
2 shelves



**C, D, E** 15297140  
Sliding rack  
2 shelves



**F** 15298140  
Sliding rack  
3 shelves



**G** 5293140  
Optional divider available for pull-out  
systems A, C, D, E and F.



**H** 480483100  
Non-slip mat for narrow shelves to  
stabilize containers and minimize noise.

Fig.	Code	Description	Product dimensions (W x D x H)			Finish
			Width	Depth	Height	
<b>A</b>	115399140	Sliding rack with towel rack	4 7/16" (112 mm)	19" (481 mm)	23 1/4" (590 mm)	Chrome
<b>B</b>	115400140	Sliding rack with cookware storage	4 7/16" (112 mm)	19" (481 mm)	23 1/4" (590 mm)	Chrome
<b>C</b>	15297140	Sliding rack 2 shelves	4 7/16" (112 mm)	19" (481 mm)	21 1/4" (540 mm)	Chrome
<b>D</b>	15297100	Sliding rack 2 shelves	4 7/16" (112 mm)	19" (481 mm)	21 1/4" (540 mm)	Silver grey
<b>E</b>	15297906	Sliding rack 2 shelves	4 7/16" (112 mm)	19" (481 mm)	21 1/4" (540 mm)	Dark grey
<b>F</b>	15298140	Sliding rack 3 shelves	4 7/16" (112 mm)	19" (481 mm)	29 23/32" (755 mm)	Chrome
<b>G</b>	5293140	Shelf divider	N/A			Chrome
<b>H</b>	480483100	Anti-slip mat	3 5/16" (84 mm)	17 1/4" (438 mm)		Dark grey



FOOD STORAGE



STORAGE



CLEANING



PREPARATION

## BASE CABINETS

## FIORO PULL-OUT STORAGE

*Fioro, the perfect combination of wood and metal*

*Fioro* is the perfect solution for narrow cabinets, providing an ideal space for storing oils, vinegars, spices, and cleaning products.



- + Full-extension runner system provides complete access from both sides.
- + Ensures perfect stability through side and door mounting.
- + Available in two configurations: shelves or shelf and towel rail.
- + Fixed shelves come with two oak profiles.
- + Features a dark grey metal frame and shelf structure.
- + Equipped with a soft-close mechanism.
- + Load capacity – *Fioro 150/200*: 33 lb (15 kg).
- + Load capacity – *Fioro 300*: 44 lb (20 kg).
- + Non-slip mats are included for added convenience.



**A** Fioro with 2 shelves available in 3 widths



The oak profiles can be removed and restained to your taste, or replaced with glass or other materials. Specifications available on [richelieu.com](http://richelieu.com)



**B** Fioro towel rail



Fig.	Code	Description	Int. dimensions required (W x D x H)		
			Width	Depth	Height
<b>A</b>	22118906	<i>Fioro 150</i> , dark grey	4 7/16" (112 mm)	18 3/4" (475 mm)	20 1/2" (520 mm)
<b>A</b>	22119906	<i>Fioro 200</i> , dark grey	6 3/8" (162 mm)	18 3/4" (475 mm)	20 1/2" (520 mm)
<b>A</b>	22120906	<i>Fioro 300</i> , dark grey	10 5/16" (262 mm)	18 3/4" (475 mm)	20 1/2" (520 mm)
<b>B</b>	22121906	<i>Fioro towel rail 150</i> , dark grey	4 7/16" (112 mm)	18 3/4" (475 mm)	26" (660 mm)





**A** Door-mounted CooKo system

## A reinvented cooking space

CooKo streamlines the storage of all essentials required for meal preparation and cooking, including spices, oils, vinegars, cutting boards, knives, and more.



**A**

- + Modular design that offers flexibility to tailor the arrangement of shelves and the entire storage system to suit your preferences.
- + Full-extension runners with soft-closing mechanism are mounted at the bottom of the cabinet.
- + Shelves are removable for easy cleaning.
- + Load capacity of 36 lb (16 kg).
- + Features a chrome wire frame and silver grey polymer shelf.



**B** Vario towel rail

Vario provides an extensive selection of storage solutions for essential food preparation and cleaning items, ensuring everything is conveniently accessible.



**B**

- + The 3-branch towel rail serves as an excellent complementary item.
- + Versatile: can be installed on either the left or right side of the cabinet.

Fig.	Code	Description	Int. dimensions required (W x D x H)			Finish
			Width	Depth	Height	
<b>A</b>	25235140100	Door-mounted CooKo system	10 1/4" (260 mm)	19 1/4" (489 mm)	24 5/8" (625 mm)	Silver grey/chrome
<b>B</b>	3133170	Vario 3-branch towel rack	7 15/32" (190 mm)	18" (457 mm)	3 1/2" (89 mm)	Aluminium



FOOD STORAGE STORAGE CLEANING PREPARATION

## BASE CABINETS

## SNELLO PULL-OUT STORAGE

### *Storage solutions with minimalist design*

*Snello*: Perfect for dry food storage. Bid farewell to wasted space with this system, providing complete access to both sides of the cabinet!



- + Full-extension pull-out system ensures full access from both sides.
- + Side and door installation ensures optimal stability.
- + Fixed shelves maximize storage efficiency.
- + Load capacity of 33 lb (15 kg) for models 150/200, and 45 lb (20 kg) for model 300.
- + Non-slip mats are included (excluding model #20150110).
- + Soft-close mechanism for gentle closing.
- + *Slim* basket sides maximize storage space utilization.



**A** *Snello 200/300 with anti-slip mat.*



**B** *Snello 150 (non-slip mat #480483100 sold separately)*



**C** *A non-slip towel rack and a bin for storing small items.*

Fig.	Code	Description	Min. int. width required	Min. int. depth required	Min. int. height required	Finish
<b>A</b>	20200110	<i>Snello</i> pull-out system	6 5/16" (160 mm)	18 3/4" (475 mm)	20 1/2" (520 mm)	Silver grey
<b>A</b>	20300110	<i>Snello</i> pull-out system	10 1/4" (262 mm)	18 3/4" (475 mm)	20 1/2" (520 mm)	Silver grey
<b>B</b>	20150110	<i>Snello</i> pull-out system	4 7/16" (112 mm)	18 3/4" (475 mm)	20 1/2" (520 mm)	Silver grey
<b>C</b>	20189110	<i>Snello</i> towel rack	4 7/16" (112 mm)	18 3/4" (475 mm)	26" (660 mm)	Silver grey

## ADJUSTABLE PULL-OUT STORAGE BASKET

## BASE CABINETS



A Pantry cabinet application



A Base cabinet application

*A single product serving various purposes*

A versatile and sophisticated solution to simplify your daily life.

This adjustable pull-out storage basket maximizes storage efficiency, perfectly fitting under-sink cabinets, base cabinets, and pantries of varying widths.

Suitable for hinged-door cabinets from 15" to 24" (381 to 609.6 mm) wide and framed cabinets from 18" to 24" (457.2 to 609.6 mm). Can also be used in under-sink cabinets measuring 30" (762 mm) and over.



- + Multi-purpose storage basket in chrome-plated steel with adjustable width.
- + Bottom-mounted, full-extension runners with cushioned closure.
- + Width-adjustable product suitable for a wide variety of uses.
- + Ergonomic handle for maximum user comfort.
- + Enhance your space planning with this versatile suitable for various kitchen or cleaning items.
- + Easy installation of the adjustable basket at the bottom of the cabinet.
- + Universally fits both framed and frameless cabinets.
- + Load capacity of 44 lb (20 kg).

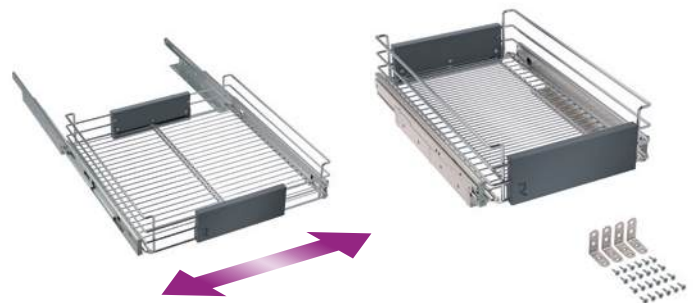

A



This pull-out basket can also be installed on pantry shelves using the included brackets.



**Min. int. depth required:** 20 1/16" (510 mm)  
**Basket height:** 5 3/16" (132 mm)

Fig.	Code	Description	Min. int. width required	Min. int. depth required	Min. int. height required	Finish
A	CSL12A20205SC	Pull-out adjustable chrome wire storage basket	Min. 13 1/2" to 21 1/4" (342 to 540 mm)	21 1/4" (540 mm)	5 1/2" (139 mm)	Chrome & dark grey



Portero



Towel rack

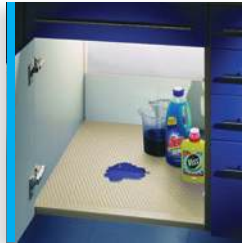

Protective mat



Pull-out shelf

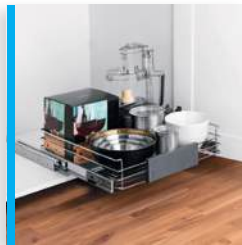

Sliding storage shelf

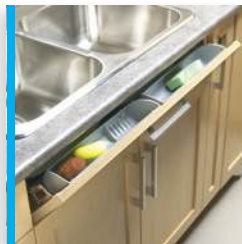

Tip-out trays

*No more chaos  
in the under-sink  
cabinet!*

Fed up with cleaning products, sponges, and garbage bags scattered all over the place? Our storage accessories provide an elegant and practical solution.

For additional storage solutions, see our *Waste bins* and *Recycling centers*, as well as *Base cabinets* sections.

Towel racks	60
Tray dividers and protective mats	61
Pull-out shelves	62
Tip-out trays	63



STORAGE



CLEANING

## UNDER-SINK CABINETS

## TOWEL RACKS



*At last an organized space!*

With Richelieu's range of products, functionality meets practicality in any cabinet. Waste bins that open simultaneously with the door, pull-out shelves for your cleaning supplies, and sliding towel racks ensure everything is neatly organized and readily accessible.



If your towel rack is attached on the hinge side you may need to use spacers (#60285012).



**A** 3143100, 314330  
Left, right, top or back of the cabinet installation



**B** 5051140  
Left or right installation



**C** 3133170  
Left, right or top of the cabinet installation



**D** 860830  
Towel rack for door



**E** 60285012

Fig.	Code	Description	Min. int. dimensions required (W x D x H)			Finish
			Width	Depth	Height	
<b>A</b>	314330	3-branch pull-out towel rack, PVC steel construction	7 1/2" (191 mm)	17 1/8" (435 mm)	3 5/8" (92 mm)	White
<b>A</b>	3143100	3-branch pull-out towel rack, PVC steel construction	7 1/2" (191 mm)	17 1/8" (435 mm)	3 5/8" (92 mm)	Grey
<b>B</b>	5051140	3-branch pull-out towel rack, with steel construction	6 11/16" (170 mm)	19 7/8" (505 mm)	2" (50 mm)	Chrome
<b>C</b>	3133170	3-branch pull-out towel rack, ABS aluminum construction	7 1/2" (190 mm)	18" (457 mm)	3 1/2" (89 mm)	Aluminium
<b>D</b>	860830	Wire towel rack, metal wire construction	13" (330 mm)	3 1/2" (89 mm)	7" (178 mm)	White
<b>E</b>	60285012	1" (25 mm) side spacer				White



STORAGE



CLEANING

*Protect the bottom of  
your under-sink cabinets!*

**Protective mat to guard against leaks and spills**

Designed using an exclusive patented method, these mats feature a surface comprising tiny cells capable of absorbing up to 1,05 qt (1 liter) of liquid per square meter (10.76 sq. ft.). This feature applies to mats A, B and C. All mats are customizable, allowing them to be easily cut to the desired size.



**A** 461162170, 461187170



**B** 461162150



**C** 461187906



**D** 471084140 (optional)  
Under-sink mat gasket



**E** 61187100

**Tray dividers:**

Perfect for holding cutting boards, baking trays, pan lids and pots in place. They are easy to install, with just four screws.



**F** 10012-100/30,  
1001830



**G** 003930, 6251140



**H** 001230, 001830



**I** 0012140, 0018140

Fig.	Code	Description	Min. int. dimensions required (W x D x H)	Mounting type	Finish
<b>A</b>	461162170	Under-sink mat, can be cut	Max. 45 3/4" x 23 5/8" (1,162 x 600 mm)		Stainless steel
<b>A</b>	461187170	Under-sink mat, can be cut	Max. 46 3/4" x 23 5/8" (1,187 x 600 mm)		Stainless steel
<b>B</b>	461162150	Under-sink mat, can be cut	Max. 45 3/4" x 23 5/8" (1,162 x 600 mm)		Maple
<b>C</b>	461187906	Under-sink mat, can be cut	Max. 46 3/4" x 23 5/8" (1,187 x 600 mm)		Dark grey
<b>D</b>	471084140	Under-sink mat gasket, can be cut	Max. 49 1/4" x 15/32" x 3/16" (1,250 x 12 x 5 mm)		Chrome
<b>E</b>	61187100	Econo under-sink protective mat	46 3/4" x 23 5/8" (1,187 x 600 mm)		Grey
<b>F</b>	10012-100/30	Single tray divider	D = 12 1/4" (310 mm), H = 19 1/4" (488 mm)	Screw-on: bottom and rear	Grey/white
<b>F</b>	1001830	Single tray divider	D = 18 3/16" (462 mm), H = 19 1/4" (488 mm)	Screw-on: bottom and rear	White
<b>G</b>	003930	Double tray divider	3 3/16" x 12 1/4" x 10 3/16" (81 x 310 x 259 mm)	Screw-on: bottom	White
<b>G</b>	6251140	Double tray divider	3 3/16" x 12 1/4" x 10 3/16" (81 x 310 x 259 mm)	Screw-on: bottom	Chrome
<b>H</b>	001230	Single tray divider	D = 19 3/4" (502 mm), H = 12 1/4" (310 mm)	Screw-on: bottom and rear	White
<b>H</b>	001830	Single tray divider	D = 19 3/4" (502 mm), H = 18 1/4" (464 mm)	Screw-on: bottom and rear	White
<b>I</b>	0012140	Single tray divider	D = 19 3/4" (502 mm), H = 12 1/4" (311 mm)	Screw-on: bottom and rear	Chrome
<b>I</b>	0018140	Single tray divider	D = 19 3/4" (502 mm), H = 18 1/4" (464 mm)	Screw-on: bottom and rear	Chrome



## UNDER-SINK CABINETS

## PULL-OUT SHELVES



**A** 5153140  
The top shelf tilts to either side for easy access.



**B** 5151140  
One-shelf version



**C** 51502140  
Two-shelf version  
Complementary manual pull-out waste bins type 3632 or 3666100

*Say goodbye to any mess!*



**Portero**

### A, B and C

- + Bottom-mounted.
- + Full extension for complete access.
- + Easy-to-remove shelves.
- + The plastic base of chrome shelves is resistant to cleaning agents.
- + Perfect for cleaning supplies, as well as water bottles, oil, vinegar, etc.
- + Dividers available for organizing shelves into compartments.
- + Fixed shelf with shock absorber for gentle closing.



**D** The #CSL12A20205SC product features adjustable width, allowing it to accommodate various cabinet widths.

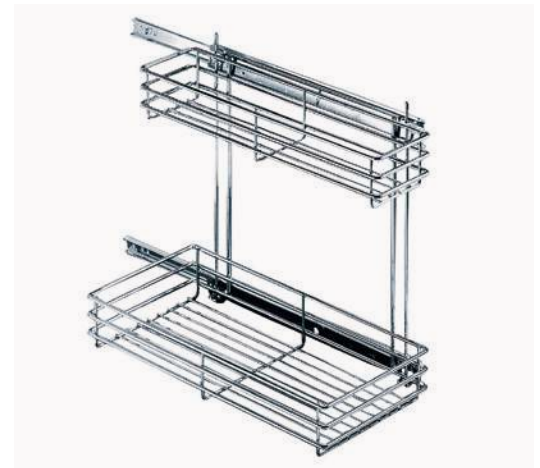

**E**

Fig.	Code	Description	Min. int. dimensions required (W x D x H)			Opening type	Finish
			Width	Depth	Height		
<b>A</b>	5153140	Removable sliding shelves (3 shelves)	11" (280 mm)	19 11/16" (500 mm)	20 3/16" (512 mm)	Manual	Grey/chrome
<b>B</b>	5151140	Removable sliding shelves (1 shelf)	6 1/2" (165 mm)	19 11/16" (500 mm)	15 3/4" (400 mm)	Manual	Grey/chrome
<b>C</b>	51502140	Removable sliding shelves (2 shelves)	11" (280 mm)	19 11/16" (500 mm)	15 3/4" (400 mm)	Manual	Grey/chrome
<b>D</b>	CSL12A20205SC	Sliding adjustable chrome wire storage shelves	13 1/2" to 21 1/4" (342 to 540 mm)	21 1/4" (540 mm)	5 1/2" (139 mm)		Dark grey/chrome
<b>E</b>	5139140	Sliding rack	8 15/32" (215 mm)	18 1/2" (470 mm)	16 17/32" (420 mm)		Chrome





STORAGE



CLEANING



Available in 11" (279 mm) or 14" (355 mm) versions

## A convenient hidden space

Explore our range of tip-out trays designed to provide discreet, integrated additional storage. Convert unused areas into practical storage space for items like sponges, brushes, steel wool, and more.



- + Includes a set of 2 tip-out trays and hinges.
- + Available in lengths of 11" or 14" (279 or 355 mm).
- + Available in white or silver grey finishes.
- + Features a standard tray and a tray with a hook for securing jewelry (rings, etc.).
- + Also available in sets of 20 single trays and 20 trays with dividers. For further information, visit [richelieu.com](http://richelieu.com).



Each set includes: two trays (one standard and one with hook) along with two pairs of scissor hinges.



A White



One of the trays features a hook designed to keep your rings secure.

Fig.	Code	Description	Product dimensions (W x D x H)		Height	Finish
			Width	Depth		
A	96572130	Set of 2 tip-out trays 11" (280 mm)	11" (280 mm)	2 3/16" (55 mm)	3 13/16" (97 mm)	White
A	96572430	Set of 2 tip-out trays 14" (362 mm)	14 1/4" (362 mm)	2 3/16" (55 mm)	3 13/16" (97 mm)	White



*Pegasus*

## Unleash the full potential of your upper cabinets

Kitchen upper cabinets are often used to store items and consumable foods that require easy access. However, their height and depth can sometimes make them difficult to access. Richelieu offers retractable or sliding systems as a solution to this issue.



*Pegasus*



*Twister*



*Pull-out basket*

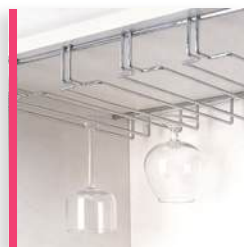

*Triple wine glass rack*

<i>Pegasus</i> pull-down system	64
<i>Twister</i> system	66
<i>Tandem</i> and <i>Picanto</i> pull-out storage system	68
Pull-out spice rack	69
Storage accessories	70
Wine glass and bottle racks	71



FOOD STORAGE STORAGE

## UPPER CABINETS

## PEGASUS PULL-DOWN SYSTEM



*Cabinets within everyone's reach!*

The *Pegasus* retractable system offers an optimal solution for accessing items stored in upper cabinets. This system lowers the contents to the desired height, providing convenient access.



- + Pull-down basket system with integrated handle for improved ergonomics, ensuring effortless movement.
- + Streamlined central assembly for easy installation.
- + Height-adjustable mechanism simplifies installation within the cabinet.
- + Rotary mechanism allows for adjustable opening force.
- + Clip-on metal baskets with non-slip mats.
- + Customers have the option to create their own baskets using brackets #5088110, which can be fixed to the mechanism.



The customer can make their own baskets



A



B



C



Depth:  
11 1/4" to 13" (285 to 330 mm)  
Height:  
26" to 37 1/4" (660 to 946 mm)

For a complete set, order one mechanism and 4 baskets

Fig.	Code	Description	Min. width required	Capacity	Finish
A	5083110	<i>Pegasus</i> mecanism	N/A	0 to 26.5 lb (0 to 12 kg)	Aluminium grey
A	5084110	<i>Pegasus</i> mecanism	N/A	22 to 44 lb (10 to 20 kg)	Aluminium grey
B	5085110	4 <i>Pegasus</i> baskets	33 15/16" (862 mm)	N/A	Aluminium grey
B	5087110	4 <i>Pegasus</i> baskets	45 3/4" (1,162 mm)	N/A	Aluminium grey
C	5088110	Wood basket support	N/A	N/A	Aluminium grey

Visit [richelieu.com](http://richelieu.com) for more information

**PEGASUS  
PULL-DOWN SYSTEM**

**UPPER-CABINETS**





FOOD STORAGE STORAGE

## UPPER CABINETS

## TWISTER SYSTEM FOR CORNER CABINETS



A Twister set with 2 trays, maple

### 135° corner cabinet system

The *Twister* system is a pivoting mechanism for angled upper cabinets designed to optimize access to storage space.



- + Height-adjustable posts and trays.
- + Rear-mounted post, maximizing storage space and enhancing accessibility.
- + D-shaped design, perfect for corner cabinets.
- + Trays available in gray or maple non-slip melamine, with chrome contours.
- + Load capacity per tray: 20 lb (8.16 kg).



Equipped with a mechanism that prevents the trays from pivoting when they face the front of the cabinet.



A Twister set with 3 trays, silver grey



Fig.	Code	Description	Shelf diameter	Min. depth required	Min. height required	Shelves	Finish
A	2561140100	Twister kit	20 1/2" (520 mm)	22 1/8" (562 mm)	25 15/16 to 30 1/2" (659 to 775 mm)	2	Silver grey
A	2561140150	Twister kit	20 1/2" (520 mm)	22 1/8" (562 mm)	25 15/16 to 30 1/2" (659 to 775 mm)	2	Maple
A	2562140100	Twister kit	20 1/2" (520 mm)	22 1/8" (562 mm)	32 to 36 1/2" (813 to 927 mm)	3	Silver grey
A	2562140150	Twister kit	20 1/2" (520 mm)	22 1/8" (562 mm)	32 to 36 1/2" (813 to 927 mm)	4	Maple





FOOD STORAGE STORAGE

## UPPER CABINETS

## TANDEM AND PICANTO PULL-OUT STORAGE SYSTEM



A



B



C

### Tandem

Tandem is a system that optimizes storage and access to contents.



- + Full access to cabinet contents in a single movement.
- + Designed for cabinets with hinged doors.
- + Reversible design allows for left or right-hand opening.
- + Unit comprising a sliding component and a door-mounted basket.



#### Minimum interior installation dimensions required:

Width: 10 5/16" (262 mm)  
Depth: 11" (280 mm)  
Height: 27 1/2" (700 mm)

**For a complete set, please order items A, B and C**

Fig.	Code	Description	Finish	Qty to order
A	1271140	3 door-mounted baskets	Chrome	1
B	1270140	3 inner shelves	Chrome	1
C	1272140	Opening mechanism	Chrome	1



**Note:** The customer must provide a 5/8" (16 mm) thick back panel (not included).



Product shown: 150 mm version (5095110)



#### Minimum interior installation dimensions required:

Width: 50095110 = 4 7/16" (112 mm)  
50094110 = 10 5/16" (262 mm)  
Depth: 11 1/4" (285 mm)  
Height: 23 1/4" (590 mm)

### Picanto

Picanto is a three-shelves pull-out system for narrow upper cabinets.



- + Enhance storage efficiency in compact upper cabinets with a three-shelves pull-out system.
- + Transparent baskets with adjustable height offer a clear view of stored items.
- + Reversible design allows for left or right-hand opening.
- + Frame mounts onto the door for easy installation.
- + Full-extension soft-closing runners for smooth operation.
- + Available in two widths, with minimum inside measurements of 4 7/16" (112 mm) or 10 5/16" (262 mm).

Fig.	Code	Description	Finish
A	50095110	Pull-out system 150	Silver grey
B	50094110	Pull-out system 300	Silver grey



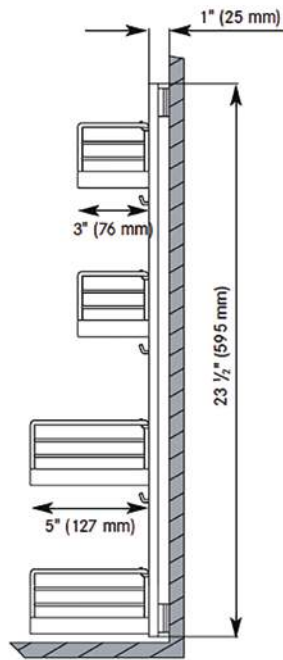

**A practical solution for upper cabinets**

The *Arena Plus* pull-out rack offers an efficient solution to maximize storage and simplify the organization of spices and oils.



- + Upper cabinet pull-out system, perfect for organizing herbs, spices, oils, preserves, and more.
- + Reversible side-mounted frame supports up to four shelves, each with a load capacity of 18 lb (8 kg).
- + Baskets are height-adjustable and sold in sets of two.
- + Available in two widths.
- + Non-slip surface ensures items remain secure.
- + Features a cushioned closing mechanism.
- + Each basket features a sleek chrome contour.
- + Basket finishes available in grey/silver or maple/chrome.



**Framed cabinet**

Min. opening width required: 1 1/4" (32 mm) + width of widest shelf (use spacers if necessary).

**Frameless cabinet**

Min. interior width required: 1 1/4" (32 mm) + width of widest shelf.



A



B



C



C



Use #60285012 spacers for installation in a frameless cabinet.



**Order 1 frame, 1 set of runners and the required number of shelves**

Fig.	Code	Description	Int. height/opening	Finish
A	2579100	Reversible frame	Min. 23 1/2" (596 mm)	Silver grey
B	2578100	Set of runners		Silver grey

Fig.	Code	Description	Product dimensions (W x D x H)			Finish
			Width	Depth	Height	
C	2581140100	Set of 2 shelves	3" (77 mm)	9 7/8" (251 mm)	2 3/4" (70 mm)	Silver grey/chrome
C	2582140100	Set of 2 shelves	5" (127 mm)	9 7/8" (251 mm)	2 3/4" (70 mm)	Silver grey/chrome
C	2581140150	Set of 2 shelves	3" (77 mm)	9 7/8" (251 mm)	2 3/4" (70 mm)	Maple/chrome
C	2582140150	Set of 2 shelves	5" (127 mm)	9 7/8" (251 mm)	2 3/4" (70 mm)	Maple/chrome



FOOD STORAGE STORAGE

UPPER CABINETS

STORAGE ACCESSORIES

*Essential and easily usable within minutes*



A Product shown: spice rack

A Spice rack



B Ideal for holding objects in place on a shelf



C The set includes a plate rack and a shelf



D Wooden plate rack

Fig.	Code	Description	Product dimensions (W x D x H)			Finish
			Width	Depth	Height	
A	1301140	Spice rack	9 19/32" (244 mm)	2 5/8" (66 mm)	15 1/2" (395 mm)	Chrome
A	1310140	Spice rack	14 3/4" (375 mm)	2 5/8" (66 mm)	16 3/4" (425 mm)	Chrome
B	8802140	Shelf gallery	13 3/4" (348 mm)	13/32" (10 mm)	1 1/2" (39 mm)	Chrome
B	8803140	Shelf gallery	5 11/16" (398 mm)	13/32" (10 mm)	1 1/2" (39 mm)	Chrome
B	8805140	Shelf gallery	21 9/16" (548 mm)	13/32" (10 mm)	1 1/2" (39 mm)	Chrome
C	570170	Plate rack	26" to 26 3/4" (660 to 680 mm)	9 3/4" (247 mm)		Stainless steel
C	585170	Plate rack	31 7/8" to 32 5/8" (810 to 830 mm)	9 3/4" (247 mm)		Stainless steel
D	30100	Plate display unit	30" (762 mm)	1 1/2" (38 mm)	13 1/16" (332 mm)	Maple



A Product shown : triple wine glass rack

### Optimize your storage space

Wine bottles and glasses within easy reach with our racks.



- + Easy and quick installation, requiring only a few screws.
- + Wine glass holders made of high-quality chrome.
- + Wooden supports are offered in various wood species.
- + Wooden trellises for storing wine bottles, offered in various wood species.



A



B



C and D



C



D



The set includes two trellises, one for the front and the other for the back.

Fig.	Code	Description	Product dimensions (W x D x H)			Glasses/ bottles per rack	Finish
			Width	Depth	Height		
A	2750140	Three part stemware holder	10 7/8" (276 mm)	10 7/8" (276 mm)	1 3/4" (45 mm)	9	Chrome
B	88007140	Single opening stemware holder	4" (102 mm)	11" (279 mm)	1 3/8" (35 mm)	3	Chrome
C	9620150	Wood stemware rack	30" (762 mm)	12" (305 mm)	1 1/4" (32 mm)	21	Maple
C	9630150	Wood stemware rack	36" (914 mm)	12" (305 mm)	1 1/4" (32 mm)	24	Maple
C	9630250	Wood stemware rack	36" (914 mm)	12" (305 mm)	1 1/4" (32 mm)	24	Oak
D	8102430	Wine rack lattice	30" (762 mm)	7/16" (11 mm)	24" (610 mm)	18	Maple
D	8152430	Wine rack lattice	30" (762 mm)	7/16" (11 mm)	24" (610 mm)	18	Cherry
D	8252430	Wine rack lattice	30" (762 mm)	7/16" (11 mm)	24" (610 mm)	18	Oak
D	8102443	Wine rack lattice	43 1/4" (1,100 mm)	7/16" (11 mm)	24" (610 mm)	28	Maple
D	8152443	Wine rack lattice	43 1/4" (1,100 mm)	7/16" (11 mm)	24" (610 mm)	28	Cherry
D	8252443	Wine rack lattice	43 1/4" (1,100 mm)	7/16" (11 mm)	24" (610 mm)	28	Oak



SE-Cargo Short

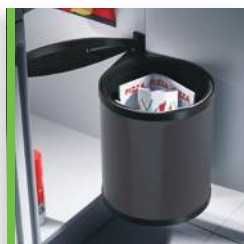

Mono pivot-out waste bin



Pull-out waste bin

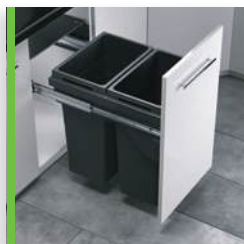

Euro-Cargo II



SE-Cargo



One2Five system

*Free up floor space and make life easier*

Recycling and waste management pose significant challenges to the environment. Richelieu's range of waste bins and recycling centres aims to simplify selective sorting on a daily basis. A well-equipped kitchen should feature a compost bin for organic waste, a recycling centre for sorting recyclables, and a waste bin for non-recyclable items.

<i>Pivot-out waste bins</i>	74
<i>Pull-out waste bins</i>	76
<i>Euro-Cargo II</i>	80
<i>SE-Cargo</i>	82
<i>SE-Cargo Short</i>	84
<i>US-Cargo</i>	85
<i>US-Cargo Synchro</i> for frameless cabinet	86
<i>US-Cargo Synchro</i> for framed cabinets	87
<i>K-Waste</i>	88
<i>Libero 3.0</i>	90
<i>Practico</i>	91
<i>One2Five</i>	92
<i>One2Four</i>	94
<i>One2Seven</i>	95



CLEANING PREPARATION

Poubelles en métal, série 3715



A 15 L, chrome, 3715140



A 15 L, silver grey, 3715100



B 15 L, graphite, 3515905

Plastic waste bins, T2700 series



C 13 L, white, T270030



C 13 L, grey, T2700100

## Pivoting and versatile

Convenient and discreet, these waste bins can be mounted in either a base cabinet or under the sink.



A

- + Capacity of 15.9 qt (15 L). 20L (21qt) options available on richelieu.com.
- + Constructed from durable metal for long-lasting performance.
- + Equipped with an automatic opening mechanism synchronized with the door.
- + When the door is opened, the lid remains inside the cabinet, providing unrestricted access to the bin.
- + Featuring a spring-loaded design, the system remains functional even during overflow, preventing waste spillage.
- + Designed to fit into spaces with an available interior width of 14 3/16" (362 mm).
- + Accessible rear space of the waste bin facilitates easy cleaning and enhances total storage capacity.
- + Reversible installation allows for right- or left-hand mount.

B

- + Capacity of 15.9 qt (15 L).
- + Ideal solution for use with soft-close hinges.
- + Reversible installation allows for right- or left-hand mount.
- + Equipped with an automatic opening mechanism synchronized with the door.
- + When the door is opened, the lid remains inside the cabinet, providing unrestricted access to the bin.
- + Available in stylish graphite finish with a black lid and base.
- + Convenient handle facilitates easy removal and cleaning.
- + All necessary hardware included for hassle-free installation.
- + Designed to fit into spaces with an available interior width of 14 1/4" (365 mm).

C

- + Same properties as model B, but in an economical version.
- + Constructed from durable polymer.
- + Available in white or grey finish.
- + Designed to fit into spaces with an available interior width of 14" (356 mm).
- + Reversible installation allows for right- or left-hand mount.

Fig.	Code	Description	Product dimensions (W x D x H)			Capacity	Type of opening	Finish
			Width	Depth	Height			
A	371530	Metal waste bin	14 3/16" (362 mm)	12 1/4" (311 mm)	16 1/2" (425 mm)	15.9 qt (15 L)	With door	White
A	3715140	Metal waste bin	14 3/16" (362 mm)	12 1/4" (311 mm)	16 1/2" (425 mm)	15.9 qt (15 L)	With door	Chrome
A	3715100	Metal waste bin	14 3/16" (362 mm)	12 1/4" (311 mm)	16 1/2" (425 mm)	15.9 qt (15 L)	With door	Silver grey
B	3515905	Mono waste bin	14 1/4" (365 mm)	12 1/16" (309 mm)	18" (460 mm)	15.9 qt (15 L)	With door	Graphite
C	T270030	Plastic waste bin	14" (356 mm)	12" (305 mm)	17 3/4" (451 mm)	13.7 qt (13 L)	With door	White
C	T2700100	Plastic waste bin	14" (356 mm)	12" (305 mm)	17 3/4" (451 mm)	13.7 qt (13 L)	With door	Silver grey



# Maximized, easy-to-access space

The *Maxi* model offers the largest capacity on the market.



**A**

- + Capacity of 31.7 qt (30 L).
- + Clip-on contour on bin holds bag securely in place.
- + Available in dark grey finish.
- + Installation in a space with an interior width of 16 3/8" (415 mm).
- + Reversible installation allows for right- or left-hand mount.

**B**

- + Capacity of 5.3 qt (5 L).
- + Ideal for vanities.
- + Provides full access to the bin when the door is opened.

**C**

- + Capacity of 19 qt (18 L).
- + Avoids the need for rear return pipes within the cabinet.
- + Full access to the bin when the door is opened.
- + Installation in a space with an interior width of 16 1/2" (419 mm).
- + Reversible installation allows for right- or left-hand mount.



**A** 30 L, dark grey, 24335110



**B** 5 L, white, 350530



**C** 18 L, white, 341830

Fig.	Code	Description	Product dimensions (W x D x H)			Capacity	Type of opening	Finish
			Width	Depth	Height			
<b>A</b>	24335110	Maxi metal waste bin	16 3/8" (415 mm)	13 3/8" (340 mm)	19 5/8" (500 mm)	31.7 qt (30 L)	With door	Silver grey
<b>B</b>	350530	Plastic waste bin	11 3/4" (300 mm)	7 9/16" (192 mm)	13 3/8" (340 mm)	5.3 qt (5 L)	With door	White
<b>C</b>	341830	Metal waste bin	16 1/2" (419 mm)	8" (203 mm)	18" (457 mm)	19 qt (18 L)	With door	White



CLEANING PREPARATION



**A** 1 x 21.1 qt (20 L), dark grey, 3635910, 3636910



**B** 2 x 15.9 qt (15 L), grey, 3650100



**C** 2 x 15.9 qt (15 L), grey, 3666100



**D** 2 x 14.8 qt (14 L), stainless steel, 2500170



**E** 2 x 14.8 qt (14 L), beige, 2270100



**F** 1 x 221.1 qt (20 L), beige, 2260100  
*The clever lid hinges upward, providing full access, and the bin can be effortlessly removed.*



**G** 2 x 15.9 qt (15 L), white and blue, 3667030  
*Durable antibacterial protection tested against more than 50 types of bacteria.*

## The essentials!



- + Easy bottom-of-cabinet installation.
- + Materials: metal frame and plastic tray.
- + Finishes: grey, dark grey, beige, and stainless steel.
- + Certain models can be door-mounted for convenient single-motion opening and access.
- + Available in one or two bins configuration.
- + Lids remain inside the cabinet, allowing easy removal of bins fitted with handles.
- + Lids offer additional storage space on top, ideal for bags or other items.
- + Large capacity makes it suitable for tight spaces like under-sink cabinets.

Fig.	Code	Description	Min. int. dimensions required (W x D x H)			Capacity	Extension	Opening	Finish
			Width	Depth	Height				
	3635910	Solo waste bin	10 5/8" (270 mm)	16 13/16" (427 mm)	15 19/32" (396 mm)	21.1 qt (20 L)	Full access	Manual	Dark grey
<b>A</b>	3636910	Solo waste bin	14 3/16" (360 mm)	16 13/16" (427 mm)	15 19/32" (396 mm)	21.1 qt (20 L)	Full access	With door	Dark grey
<b>B</b>	3650100	Tandem waste bin	10 7/8" (277 mm)	19 7/8" (505 mm)	17 15/16" (455 mm)	2 x 15.9 qt (15 L)	Full access	Manual	Grey
<b>C</b>	3666100	Tandem waste bin	10 7/8" (276 mm)	19 1/8" (485 mm)	15 15/16" (405 mm)	2 x 15.9 qt (15 L)	Full access	Manual	Grey
<b>D</b>	2500170	Stainless steel double waste bin	14 1/4" (362 mm)	17 3/8" (440 mm)	16 1/2" (420 mm)	2 x 14.8 qt (14 L)	Full access	With door	Stainless steel
<b>E</b>	2270100	Double waste bin	11" (280 mm)	17 3/4" (450 mm)	18 1/2" (470 mm)	2 x 14.8 qt (14 L)	Full access	Manual	Beige
<b>F</b>	2260100	Single waste bin	11" (280 mm)	17 3/4" (450 mm)	18 1/2" (470 mm)	21.1 qt (20 L)	Full access	Manual	Beige
<b>G</b>	3667030	Tandem antibacterial waste bin	10 7/8" (276 mm)	19 1/8" (485 mm)	15 15/16" (405 mm)	2 x 15.9 qt (15 L)	Full access	Manual	Blue and white



## PULL-OUT WASTE BINS AND RECYCLING CENTRES, BOTTOM-MOUNTED

## WASTE BINS AND RECYCLING CENTERS



**A** 2 x 8.9 qt + 1 x 19 qt (8,5 L + 1 x 18 L), silver grey, 3642100



**B** 2 x 19 qt (18 L), silver grey, 3641100



**C** 2 x 19 qt (18 L), black and white, 364090

*Compact yet high-capacity models*



### A, B, C and D

- + Ideal for waste management, these bins feature a low installation height and high capacity.
- + Integrated lids for additional storage space.
- + Bins are equipped with ergonomic handles.
- + Designed for installation on hinged doors.

### (D)

When mounted at the bottom and alongside the door, this sliding waste bin is convenient, saving kitchen space and minimizing odors. Equipped with an automatic opening mechanism, it simplifies waste disposal. Benefit from two bins, sized at 19 and 12.68 qt (18 and 12 L) respectively, for an efficient sorting.



**D** 1 x 19 qt + 1 x 12.68 qt (18 L + 1 x 12 L), silver grey, 3644100

This waste bin is designed to fit into base cabinets with an available interior width of 22 1/8" (562 mm).



**E** 1 x 42.3 qt (40 L), white, 640530



**E** Product application shown

### (E) The versatile

This standalone floor bin is versatile enough for any room in the house. Alternatively, it can be mounted on a pull-out shelf (not included) to function as a 2 x 42.3 qt (40 L) recycling centre. Ingeniously, the lid closes automatically for added convenience.

Fig.	Code	Description	Min. int. dimensions required (W x D x H)			Capacity	Extension	Opening	Finish
			Width	Depth	Height				
<b>A</b>	3642100	Tandem triple waste bin	14 5/8" (371 mm)	18 7/8" (480 mm)	13 3/8" (341 mm)	2 x 8.9 qt + 1 x 19 qt (8.5 L + 1 x 18 L)	Full access	Manual	Silver grey
<b>B</b>	3641100	Tandem double waste bin	14 5/8" (371 mm)	18 7/8" (480 mm)	13 3/8" (341 mm)	2 x 19 qt (18 L)	Full access	Manual	Silver grey
<b>C</b>	364090	Double waste bin	14 5/8" (371 mm)	18 1/2" (470 mm)	12 3/4" (325 mm)	2 x 19 qt (18 L)	3/4 extension	Manual	Black and white
<b>D</b>	3644100	Tandem double waste bin	22 1/8" (562 mm)	13 5/16" (343 mm)	14 3/16" (365 mm)	1 x (19 qt + 12.68 qt) (18 L + 1 x 12 L)	Full access	Manual or with door	Silver grey
<b>E</b>	640530	Floor model waste bin	10 1/4" (260 mm)	13 3/8" (340 mm)	19 7/8" (500 mm)	42.3 qt (40 L)	Full access	N/A	White



CLEANING PREPARATION



**A** 2 x 37 qt (35 L), silver grey, 255070100



**B** 2 x 31.7 qt (30 L), silver grey, 255160100

## Convenient and universal



### A, B, C and D

- + Easy installation at the bottom of the cabinet.
- + Internal lid securely fixed inside the cabinet.
- + Comes with two bins for a single full-height door (model #255070100) or under a drawer (model #255160100).
- + Suitable for installation in both framed and frameless cabinets.
- + Features an ergonomic handle for effortless opening.
- + Equipped with full-extension runners for complete access and easy bin removal.
- + Optional damped closing mechanism available (sold separately – model #15510100).
- + Installation in sliding door version with brackets (sold separately – model #5520100).



**C** Door bracket (optional)



**D** Soft-closing mechanism (optional)

For use with hinged doors or as a pull-out door



### E, F and G

- + A space-saving pull-out waste bin, perfect for narrow interiors.
- + Equipped with full-extension runners for effortless bin removal and complete access.
- + Designed for hinged doors.
- + Ultra-easy bottom mounting requiring only four screws.
- + Available in generous capacities: 42.3 qt (40 L), 44.4 qt (42 L), and 51.8 qt (49 L).
- + Fixed inner lid increases storage capacity.
- + Available in silver grey finish.



**E** 1 x 42.3 qt (40 L), silver grey, 6294100



**G** 1 x 44.3 qt (42 L), silver grey, 366840100



**F** 1 x 31.7 qt (30 L) et 1 x 20 qt (19 L), silver grey, 366850100

Fig. Code	Description	Min. int. dimensions required (W x D x H)			Capacity	Fini
		Width	Depth	Height		
<b>A</b> 255070100	Recycling center	16 1/4" (412 mm)	19 1/2" (495 mm)	23 3/8" (595 mm)	2 x 37 qt (35 L)	Silver grey
<b>B</b> 255160100	Recycling center	16 1/4" (412 mm)	19 1/2" (495 mm)	20 1/4" (511 mm)	2 x 31.7 qt (30 L)	Silver grey
<b>C</b> 55520100	Door mounting bracket	N/A	N/A	N/A	N/A	Silver grey
<b>D</b> 15510100	Soft-Close* mechanism	N/A	N/A	N/A	N/A	Silver grey
for 2250 and 2551						
<b>E</b> 6294100	Narrow waste bin	11" (280 mm)	17 3/4" (450 mm)	21 1/8" (537 mm)	1 x 42.3 qt (40 L)	Silver grey
<b>F</b> 366850100	Easy-Cargo recycling center	17 15/16" (455 mm)	18 5/16" (465 mm)	18 1/8" (460 mm)	1 x 31.7 qt (30 L) 1 x 20 qt (19 L)	Silver grey
<b>G</b> 366840100	Easy-Cargo recycling center	13 19/32" (345 mm)	18 5/16" (465 mm)	21 17/32" (547 mm)	1 x 44.3 qt (42 L)	Silver grey

\* Damped closing mechanism



## The 2-in-1 all-rounder!

Discover our range of recycling centre mounted at the bottom of the cabinet, compatible with cabinets featuring either hinged or sliding doors.



### A

- + Ensure complete access with full-extension, soft-closing slides.
- + Large capacity with 2 x 30.5 qt (2 x 29 L) bins for small spaces.
- + Heavy-duty slides support weights up to 88 lb (40 kg).
- + Designed for ergonomic use, each bin features handles for easy handling and hermetically sealed lids to contain odors.
- + Slide rails, installed beneath the cabinet, simplify setup.
- + For hinged doors, remove door mounting brackets.
- + Easy to order, each box contains one set, including lids.

**A** 2 x 30.5 qt (29 L), silver grey, 461640100

## Ecofil savers!



### B, C and D

- + Ecofil is designed for cabinets with hinged doors.
- + Constructed with a chrome-plated steel wire frame and ball-bearing runners.
- + Full or partial extension (depending on model).
- + Attaches to bottom of cabinet with just four screws.
- + Soft-close mechanism is available only in the #4424241100 model.
- + Available in two two-bin models 2 x 25.3 qt (24 L) and one three-bin model 1 x 25.3 qt + 2 x 8.4 qt (1 x 24 L + 2 x 8 L).
- + Bins are equipped with handles for easy handling and to keep bags securely in place when closed.
- + Lids are designed to minimize the spread of odors.



**B** and **C** 2 x 25.3 qt (24 L), dark grey, 4424241100 with damped closing mechanism

**D** 1 x 25.3 qt + 2 x 8.4 qt (1 x 24 L + 2 x 8 L), silver grey, 4424880100

Fig. Code	Description	Min. int. dimensions required (W x D x H)			Capacity	Extension	Finish
		Width	Depth	Height			
<b>A</b> 461640100	Recycling center 400	14 1/4" or 16 1/4"* (362 mm or 412 mm)	20 13/16" (530 mm)	21 21/32" (550 mm)	2 x 30.6 qt (29 L)	Full	Silver grey
<b>B</b> 4424240100	Ecofil recycling center	13 3/8" (340 mm)	18 1/4" (465 mm)	20 1/2" (520 mm)	2 x 25.3 qt (24 L)	Full	Silver grey
<b>C</b> 4424241100	Ecofil recycling center	12 7/8" (327 mm)	18 3/4" (475 mm)	21" (532 mm)	2 x 25.3 qt (24 L)	3/4 extension	Silver grey
<b>D</b> 4424880100	Ecofil recycling center	13 3/8" (340 mm)	18 1/4" (465 mm)	20 1/2" (520 mm)	1 x 25.3 qt (24 L) + 2 x 8.4 qt (8 L)	Full	Silver grey

\* 362 mm interior width for pull-out door version, 412 mm interior width for hinged door version.



CLEANING PREPARATION



Euro-Cargo II

## The toughest on the market!

The Euro-Cargo II series, exclusive to Richelieu, is designed to fit a wide variety of frameless cabinet widths. These models feature sturdy, ball-bearing slides that offer over-extension for easy access to all bins.



- + Side-mounted for enhanced stability and rigidity.
- + Mounting brackets enable attachment of the recycling centre frame to the door, ensuring complete access with a single motion.
- + Door mounting brackets allow three-dimensional adjustment.
- + Equipped with ball-bearing slides with over-extension for easy bin removal.
- + Includes a soft-close mechanism in most models.
- + Suitable for cabinet wall thicknesses of 5/8" (16 mm) or 3/4" (19 mm).
- + Some models come with individual lids for small bins.
- + Can be installed with full-height doors or beneath a drawer to optimize storage space based on available interior height.
- + Tested to endure over 50,000 opening cycles with 165 lb (75 kg) and over 100,000 cycles with 110 lb (50 kg).
- + Designed with ergonomic bins and handles for easy handling.
- + Reversible frame allows for changing bin configuration on models #8461440100 and #8461464XXX.
- + Available in trendy silver or dark grey finishes.
- + All Euro-Cargo II recycling centers can be optionally fitted with an automatic opening mechanism for hands-free access, such as the *Libero* or mechanical pedal, depending on the model.
- + Most models are designed for installation without spacers in metric or imperial frameless cabinets.

Fig.	Code	Description	Min. int. dimensions required (W x D x H)			Capacity	Finish
			Width	Depth	Height		
A	361430100	Euro-Cargo, 300 mm	10 1/2" (268 mm)	18 3/4" (477 mm)	22 1/16" (560 mm)	1 x 40 qt + 1 x 7.3 qt) (1 x 38 L + 1 x 7 L)	Silver grey
B	8461412100	Euro-Cargo II, 300 mm or 12"	10 5/16" to 10 3/4" (262 to 273 mm)	15 7/8" (403 mm)	17 15/16" (456 mm)	1 x 31.7 qt (1 x 30 L)	Silver grey Dark grey
C	8461435100	Euro-Cargo II, 350 mm	2 1/4" to 2 1/2" (312 to 318 mm)	21 3/4" (553 mm)	20 7/8" (530 mm)	1 x 44.4 qt (1 x 42 L)	Silver grey
D	8461440100	Euro-Cargo II, 400 mm	14 1/4" to 4 1/2" (362 to 368 mm)	21 3/4" (553 mm)	21 3/4" (552 mm)	1 x 40 qt + 1 x 12.6 qt (1 x 38 L + 1 x 12 L)	Silver grey
E*	83614100	Euro-Cargo II, 450 mm or 18"	16 1/4" to 16 3/4" (412 to 425 mm)	21 3/4" (553 mm)	21 3/4" (552 mm)	2 x 40 qt (2 x 38 L)	Silver grey
E	84614100 84614910	Euro-Cargo II, 450 mm or 18"	16 1/4" to 16 3/4" (412 to 425 mm)	21 3/4" (553 mm)	21 3/4" (552 mm)	2 x 40 qt (2 x 38 L)	Silver grey Dark grey
F	8461450100	Euro-Cargo II, 500 mm	8 3/16" to 18 7/16" (462 to 468 mm)	22 9/16" (573 mm)	20 7/8" (530 mm)	2 x 40 qt (2 x 38 L)	Silver grey
G*	8361460100	Euro-Cargo II, 600 mm or 24"	22 1/8" to 22 3/4" (562 to 578 mm)	21 3/4" (553 mm)	21 3/4" (552 mm)	2 x 40 qt + 2 x 8.9 qt (2 x 38 L + 2 x 8.5 L)	Silver grey
G	8461460100 8461460910	Euro-Cargo II, 600 mm or 24"	22 1/8" to 22 3/4" (562 to 578 mm)	21 3/4" (553 mm)	21 3/4" (552 mm)	2 x 40 qt + 2 x 8.9 qt (2 x 38 L + 2 x 8.5 L)	Silver grey Dark grey
H	8461463100 8461463910	Euro-Cargo II, 600 mm or 24"	22 1/8" to 22 3/4" (562 to 578 mm)	22 9/16" (573 mm)	20 7/8" (530 mm)	2 x 44.4 qt (2 x 42 L)	Silver grey Dark grey
I	8461464100 8461464910	Euro-Cargo II, 600 mm or 24"	22 1/8" to 22 3/4" (562 to 578 mm)	22 9/16" (573 mm)	21 3/4" (552 mm)	2 x 40 qt + 1 x 20 qt (2 x 38 L + 1 x 19 L)	Silver grey Dark grey

\* Without soft-close mechanism.

The Euro-Cargo II series



**A** 1 x 40 qt + 1 x 7.3 qt (1 x 38L + 1 x 7 L), silver grey, 361430100



**B** 1 x 31.4 qt (30 L) (for a 12" or 300 mm cabinet), silver or dark grey, 8461412100, 8461412910



**C** 1 x 44.4 qt (42 L) (for 350 mm cabinet), silver grey, 8461435100



**361430100:**  
To be used with an existing drawer;  
the frame is mounted at the bottom  
of the drawer and on the door.



**D** 1 x 40 qt + 1 x 12 qt (1 x 38 L + 1 x 12 L) (for 15 3/4" or 400 mm cabinet), silver grey, 8461440100



**E** 2 x 40 qt (38 L) (for 18" or 450 mm cabinet), silver grey or dark grey, 83614100, 84614100, 84614910



**F** 2 x 40 qt (38 L) (for 19 11/16" or 500 mm cabinet), silver grey, 8461450100



**G** 2 x 40 qt + 1 x 8.9 qt (2 x 38 L + 2 x 8.5 L) (for 24" or 600 mm cabinet), silver grey or dark grey, 8361460100, 8461460100 / 8461460910



**H** 2 x 44.4 qt (42 L) (for a 24" or 600 mm cabinet), silver grey or dark grey, 8461463100, 8461463910



**I** 2 x 40 qt + 1 x 20 qt (2 x 38 L + 1 x 19 L) (for a 24" or 600 mm cabinet), silver or dark grey, 8461464100, 8461464910



**Installation:**

All models (excluding A, #361430100) are equipped with a metal frame mounted on both right and left runners for installation inside the cabinet.



CLEANING PREPARATION

## Coordinate the interior of your cabinets!

The *SE-Cargo* series showcases a straight-sided frame with concealed, synchronized runners. With integrated damped closing mechanisms, these models ensure smooth and long-lasting operation for both opening and closing actions. This product is designed to fit a diverse range of metric frameless cabinet widths.



- + Unique feature: the three-bin model (#471945XXX, developed by Richelieu) is compatible with both 450 mm and 18" cabinets.
- + Accommodates cabinet side thicknesses of 5/8" (16 mm) or 3/4" (19 mm).
- + Represents the latest generation of side-mounted recycling centres.
- + Fixed internal metal lid maximizes storage space and minimizes odor transmission.
- + Endured testing of over 100,000 cycles with 110 lb (50 kg).
- + Over-extension slides ensure easy access to all bins.
- + Door-mounted design enables complete access with a single motion.
- + Front mounting brackets feature three-way adjustment for flexibility.
- + 12.7 and 13.7 qt (12 L and 13 L) bins come with individual lids.
- + Side panels fully cover the runners, providing superior long-term protection and functionality.
- + Concealed right-hand and runner side panels are particularly suitable for use with metal drawers.



Product shown: 2 x 40 qt + 1 x 12.7 qt + 1 x 2.2 qt (2 x 38 L + 1 x 12 L + 1 x 2,5 L), 471960910



Product shown: 2 x 40 qt (2 x 38 L), 4719100



Every *SE-Cargo* recycling centres can be fitted with an optional automatic opening mechanism for hands-free access, with options including *Libero* (page 90).



Product shown: 1 x 31.7 qt + 2 x 13.7 qt (1 x 30 L + 2 x 13 L), 471945910



**A** 1 x 40 qt + 1 x 7.3 qt (1 x 38 L + 1 x 7 L) (for 350 cabinet), silver grey, 471935100



**B** 1 x 40 qt + 1 x 7.3 qt (1 x 38 L + 1 x 7 L) (for 400 cabinet), silver grey, 471940100



**C** 1 x 31.7 qt + 2 x 13.7 qt (1 x 30 L + 2 x 13 L) (for 450 cabinet), silver or dark grey, 471945100 and 471945910



**D** 2 x 40 qt (2 x 38 L) (for 450 cabinet), silver or dark grey, 4719100 and 4719910



**E** 2 x 40 qt (2 x 38 L) (for 500 cabinet), silver or dark grey, 471950100 and 471950910



**F** 2 x 40 qt + 1 x 12.7 qt + 1 x 2.2 qt (2 x 38 L + 1 x 12 L + 1 x 2.5 L) (for 600 cabinet), silver or dark grey, 471960100 and 471960910

Fig.	Code	Description	Min. int. dimensions required (W x D x H)			Capacity	Finish
			Width	Depth	Height		
<b>A</b>	471935100	SE-Cargo 350 mm	12 1/4" to 12 1/2" (312 to 318 mm)	20 3/4" (528 mm)	21 5/8" (545 mm)	1 x 40 qt + 1 x 7.3 qt (1 x 38 L + 1 x 7 L)	Silver grey
<b>B</b>	471940100	SE-Cargo 400 mm	14 1/4" to 14 1/2" (362 to 368 mm)	20 3/4" (528 mm)	21 5/8" (545 mm)	1 x 40 qt + 1 x 7.3 qt 1 (x 38 L + 1 x 7 L)	Silver grey
<b>C</b>	471945100	SE-Cargo 450 mm	16 1/4" to 16 3/4" (412 to 425 mm)	20 3/4" (528 mm)	17 7/8" (453 mm)	1 x 31.7 qt + 2 x 13.7 qt 1 (x 30 L + 2 x 13 L)	Silver grey
<b>C</b>	471945910	SE-Cargo 450 mm	16 1/4" to 16 3/4" (412 to 425 mm)	20 3/4" (528 mm)	17 7/8" (453 mm)	1 x 31.7 qt + 2 x 13.7 qt (1 x 30 L + 2 x 13 L)	Dark grey
<b>D</b>	4719100	SE-Cargo 450 mm	16 1/4" to 16 1/2" (412 to 418 mm)	20 3/4" (528 mm)	21 5/8" (545 mm)	2 x 40 qt (2 x 38 L)	Silver grey
<b>D</b>	4719910	SE-Cargo 450 mm	16 1/4" to 16 1/2" (412 to 418 mm)	20 3/4" (528 mm)	21 5/8" (545 mm)	2 x 40 qt (2 x 38 L)	Dark grey
<b>E</b>	471950100	SE-Cargo 500 mm	18 1/4" to 18 3/8" (462 to 468 mm)	20 3/4" (528 mm)	21 5/8" (545 mm)	2 x 40 qt (2 x 38 L)	Silver grey
<b>E</b>	471950910	SE-Cargo 500 mm	18 1/4" to 18 3/8" (462 to 468 mm)	20 3/4" (528 mm)	21 5/8" (545 mm)	2 x 40 qt (2 x 38 L)	Dark grey
<b>F</b>	471960100	SE-Cargo 600 mm	22 1/8" to 22 3/8" (562 to 568 mm)	20 3/4" (528 mm)	21 5/8" (545 mm)	2 x 40 qt + 1 x 12.7 qt + 1 x 2.2 qt (2 x 38 L + 1 x 12 L + 1 x 2,5 L)	Silver grey
<b>F</b>	471960910	SE-Cargo 600 mm	22 1/8" to 22 3/8" (562 to 568 mm)	20 3/4" (528 mm)	21 5/8" (545 mm)	2 x 40 qt + 1 x 12.7 qt + 1 x 2.2 qt (2 x 38 L + 1 x 12 L + 1 x 2,5 L)	Dark grey



CLEANING PREPARATION



A 1 x 37 qt (30L) (for 12" or 300 mm cabinet), silver grey, 461912100

*Large capacity solution in reduced height and depth*

The distinctive aspect of the *SE-Cargo Short* series lies in its remarkably compact design, featuring minimized installation dimensions in both depth and height, yet maintaining ample bin capacity. These units are compatible with frameless cabinets and come equipped with synchronized concealed runners featuring a dampened mechanism. Protected from dust and debris, this system ensures effortless, long-lasting operation.



- + Inner cover maximizes storage capacity and limits odor propagation.
- + Suitable for cabinet wall thicknesses of 5/8" (16 mm) or 3/4" (19 mm).
- + Product endured testing of over 100,000 cycles with a weight capacity of 110 lbs (50 kg).
- + Features over-extension slides for easy bin removal.
- + Door mounting brackets allow three-dimensional adjustment.
- + The 13.7 qt (13 L) bins come with individual lids.
- + Bins are fitted with handles for easy handling.



B 2 x 37 qt (30 L), silver grey, 461162100



C 1 x 31.7 qt + 2 x 13.7 qt (1 x 30 L + 2 x 13 L), silver grey, 461156100



D 1 x 29.59 qt + 2 x 13.74 qt (1 x 28 L + 2 x 13 L), graphite, retractable inside lid, 360860905

Fig. Code	Description	Min. int. dimensions required (W x D x H)			Capacity	Finish
		Width	Depth	Height		
A	461912100 SE-Cargo Short 12" (30 cm)	10 3/8" to 10 1/2" (262 to 268 mm)	17 5/8" (448 mm)	18 1/8" (460 mm)	1 x 37 qt L (1 x 30)	Silver grey
B	461162100 SE-Cargo Short 60 cm	22 1/8" to 22 3/8" (562 to 568 mm)	17 5/8" (448 mm)	17 5/8" (449 mm)	2 x 37 qt (2 x 30 L)	Silver grey
C	461156100 SE-Cargo Short 60 cm	22 1/8" to 22 3/8" (562 to 568 mm)	17 5/8" (448 mm)	17 5/8" (449 mm)	1 x 31.7 qt + 2 x 13.7 qt (1 x 30 L + 2 x 13 L)	Silver grey
D	360860905 SE-Cargo Short 60 cm	22 1/8" to 22 3/8" (562 to 568 mm)	15 3/4" (400 mm)	16 7/8" (429 mm)	1 x 29.59 qt + 2 x 13.74 qt (1 x 28 L + 2 x 13 L)	Graphite





**A** 2 x 37 qt + 2 x 10.6 qt (2 x 35 L + 2 x 10 L), silver grey, 461324100, lids for 10 L bins included



**B** 1 44.3 qt + 1 x 8.9 qt (1 x 40 L + 1 x 8.5 L), silver or dark grey, 461315100, 461315910, lids for 8.9 qt (8.5 L) bins included

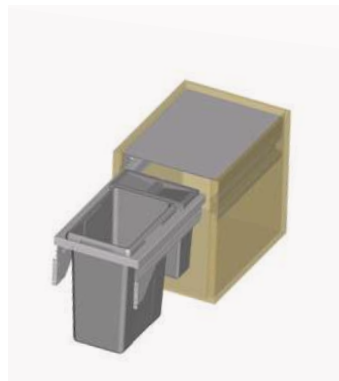

**C** 1 x 44.3 qt + 1 x 12.6 qt (1 x 42 L + 1 x 12 L), silver grey, 461318100, lid for 12.6 qt (12 L) bin included



**D** 1 x 44.3 qt + 1 x 12.6 qt (1 x 42 L + 1 x 12 L), silver or dark grey, 461321100 and 461321910



**E** Framed door support (shaker style) sold separately

## The imperial

The *US-Cargo* series, featuring full-extension ball-bearing slides, is tailored for framed cabinets of imperial dimensions, ensuring complete accessibility to the bins. Available in multiple capacities and setups, this product also incorporates a soft-close mechanism.



- + Side-mounted for enhanced stability.
- + Product endured testing of over 100,000 cycles with 110 lb (50 kg) load.
- + Equipped with heavy-duty ball-bearing slides for robustness and smooth, cushioned closing.
- + Designed for door mounting to ensure full access in a single motion.
- + Features a fixed internal metal lid, maximizing storage capacity and containing odors.
- + 8.9 and 12.6 qt (8.5 L and 12 L) bins come with individual lids.
- + Compatible with frameless cabinet installations (visit [richelieu.com](http://richelieu.com) for installation instructions).
- + Installation for full-height door mounting or under-drawer placement to optimize storage, based on available interior height.
- + Bins are easily detachable for cleaning and emptying.
- + User-friendly handles for convenient use.
- + Wide door support (E) may be necessary for certain framed doors, such as shaker-style doors.
- + Door mounting brackets allow three-dimensional adjustment.



### Installation:

#### Framed cabinet:

Minimum door opening:

461315100	W: 12" (305 mm)	H: 20 11/16" (526 mm)
461318100	W: 14 5/8" (371 mm)	H: 20 11/16" (526 mm)
461321100	W: 17 7/8" (455 mm)	H: 20 11/16" (526 mm)
461324100	W: 20 7/8" (531 mm)	H: 22 1/4" (565 mm)

Fig. Code	Description	Min. int. dimensions required (W x D x H)			Capacity	Finish
		Width	Depth	Height		
<b>A</b> 461324100	<i>US-Cargo</i> 24"	22 7/16" to 23" (570 to 584 mm)	22 3/8" (568 mm)	22 1/4" (565 mm)	2 x 37 qt (35 L) + 2 x 10.6 qt L (12 L)	Silver grey
<b>B</b> 461315100	<i>US-Cargo</i> 15"	13 1/2" to 14 1/8" (343 to 359 mm)	22 9/16" (573 mm)	20 11/16" (526 mm)	1 x 44.3 qt L (40 L) + 1 x 8.9 qt (8.5 L)	Silver grey
<b>B</b> 461315910	<i>US-Cargo</i> 15"	13 1/2" to 14 1/8" (343 to 359 mm)	22 9/16" (573 mm)	20 11/16" (526 mm)	1 x 44.3 qt L (40 L) + 1 x 8.9 qt (8.5 L)	Dark grey
<b>C</b> 461318100	<i>US-Cargo</i> 18"	16 1/2" to 16 3/4" (419 to 425 mm)	22 9/16" (573 mm)	20 11/16" (526 mm)	1 x 44.3 qt (42 L) + 1 x 12.6 qt L (12 L)	Silver grey
<b>D</b> 461321100	<i>US-Cargo</i> 21"	19 7/16" to 20" (493 to 509 mm)	22 9/16" (573 mm)	20 11/16" (526 mm)	2 x 44.3 qt (42 L)	Silver grey
<b>D</b> 461321910	<i>US-Cargo</i> 21"	19 7/16" to 20" (493 to 509 mm)	22 9/16" (573 mm)	20 11/16" (526 mm)	2 x 44.3 qt (42 L)	Dark grey
<b>E</b> SB46133613	Brackets for framed doors (shaker style), sold in pairs					Silver grey



CLEANING PREPARATION

WASTE BINS AND RECYCLING CENTERS

**US-CARGO SYNCHRO  
RECYCLING CENTRE,  
FRAMELESS CABINET**

*Designed for frameless  
imperial cabinets*

The *US-Cargo Synchro FL* series is designed for frameless imperial-sized cabinets. Featuring concealed, synchronized over-extension slides, it ensures complete access to bins. With integrated damped closing mechanisms, this series provides long-lasting operation, offering smoothness in both opening and closing motions. Available in various configurations and bin capacities, it provides versatility to suit different storage needs.



- + Side-mounted for maximum stability.
- + Tested to over 100,000 cycles with a load capacity of 110 lb (50 kg).
- + Door-mounted for full access with a single motion.
- + Equipped with a fixed internal metal lid to maximize storage space and prevent odor diffusion.
- + 15 L bins come with individual lids.
- + Bin configuration is reversible for the #481315100 model.
- + Door mounting brackets allow three-dimensional adjustment.



**A** 1 x 39 qt + 1 x 15.9 qt (1 x 37 L + 1 x 15L), silver grey, 481315100



All *US-Cargo Synchro* recycling centres can be fitted with an optional automatic opening mechanism for hands-free access (*Libero*).



Designed for frameless bottom cabinets, 15" (381 mm), 18" (457 mm), 21" (533 mm) and 24" (609 mm) bottom cabinets.



**B** 2 x 39 qt (2 x 37L), silver grey, 481318100



**C** 2 x 44 qt (2 x 42L), silver grey, 481321100



**D** 2 x 44 qt (2 x 42L), silver grey, 481324100

Fig. Code	Description	Int. dimensions required (W x D x H)	Capacity	Finish
<b>A</b> 481315100	<i>US-Cargo Synchro FL 15"</i>	13 1/2" to 13 3/4" x 22 7/16" x 20 7/32" (343 to 349 mm x 569 mm x 521 mm)	1 x 39 qt (37 L) 1 x 15.9 qt (15 L)	Silver grey
<b>B</b> 481318100	<i>US-Cargo Synchro FL 18"</i>	16 1/2" to 16 3/4" x 22 7/16" x 20 7/32" (419 to 425 mm x 569 mm x 521 mm)	2 x 39 qt (37 L)	Silver grey
<b>C</b> 481321100	<i>US-Cargo Synchro FL 21"</i>	19 1/2" to 19 3/4" x 22 7/16" x 20 7/32" (495 to 501 mm x 569 mm x 521 mm)	2 x 44.4 qt (42 L)	Silver grey
<b>D</b> 481324100	<i>US-Cargo Synchro FL 24"</i>	22 1/2" to 22 3/4" x 22 7/16" x 20 7/32" (572 to 578 mm x 569 mm x 521 mm)	2 x 44.4 qt (42 L)	Silver grey

## Designed for imperial framed cabinets

The *US-Cargo Synchro FF* series is designed for framed imperial-sized cabinets. Featuring concealed, synchronized over-extension slides, it ensures complete access to bins. With integrated damped closing mechanisms, this series provides long-lasting operation, offering smoothness in both opening and closing motions. Available in various configurations and bin capacities, it provides versatility to suit different storage needs.



- + Side-mounted for maximum stability.
- + Tested to over 100,000 cycles with a load capacity of 110 lb (50 kg).
- + Door-mounted for full access with a single motion.
- + Equipped with a fixed internal metal lid to maximize storage space and prevent odor diffusion.
- + 15.9 qt (15 L) bins come with individual lids.
- + Bin configuration is reversible for models **#491315100** and **#491318100**.
- + Door mounting brackets allow three-dimensional adjustment.



**A** 1 x 39 qt + 1 x 15.9 qt (1 x 37 L + 1 x 15 L), silver grey, 491315100



Designed for bottom cabinets with frame, 15", 18", 21" and 24" bottom cabinets.



**B** 1 x 39 qt + 1 x 15.9 qt (1 x 37 L + 1 x 15 L), silver grey, 491318100



**C** 2 x 44.4 qt (2 x 42 L), silver grey, 491321100



**D** 2 x 44.4 qt (2 x 42 L), silver grey, 491324100

Fig. Code	Description	Min. int. dimensions required (W x D x H)			Capacity	Finish
		Width	Depth	Height		
<b>A</b> 491315100	<i>US-Cargo Synchro</i> 15" FF Opening width: 12"	13 1/2" to 17 31/32" (343 to 457 mm)	22 7/16" (569 mm)	20 3/4" (527 mm)	1 x 39 qt + 1 x 15.9 qt (1 x 37 L + 1 x 15 L)	Silver grey
<b>B</b> 491318100	<i>US-Cargo Synchro</i> 18" FF Opening width: 15"	16 1/2" to 17 1/32" (419 to 433 mm)	22 7/16" (569 mm)	20 3/4" (527 mm)	1 x 39 qt + 1 x 15.9 qt (1 x 37 L + 1 x 15 L)	Silver grey
<b>C</b> 491321100	<i>US-Cargo Synchro</i> 21" FF Opening width: 18"	19 1/2" to 20 1/16" (495 to 510 mm)	22 7/16" (569 mm)	20 3/4" (527 mm)	2 x 44.4 qt (2 x 42 L)	Silver grey
<b>D</b> 491324100	<i>US-Cargo Synchro</i> 24" FF Opening width: 21"	18 9/16" to 23 1/32" (572 to 585 mm)	22 7/16" (569 mm)	20 3/4" (527 mm)	2 x 44.4 qt (2 x 42 L)	Silver grey



CLEANING PREPARATION

## A brilliant solution for bottom mounting!

K-Waste offers a sturdy waste management solution that mounts at the bottom of cabinets with simplicity in mind. Available in two frame widths and three trendy finishes, it accommodates both one- and two-bin setups. Whether door-mounted in a full-height cabinet or under a drawer with shorter bins, installation is hassle-free. Enhanced with soft-closing runners and an optional "Push To Open" feature, K-Waste will meet your needs.



- + Easy bottom and door mounting.
- + Suitable for both framed and frameless cabinets.
- + Available in one-bin or two-bin models.
- + Door mounting brackets offer three-way adjustment.
- + Compatible with cabinets featuring overlay or recessed doors.
- + Equipped with full-extension runners featuring a damped-closing mechanism.
- + Bin capacities include 28 qt, 36 qt and 52 qt (26.5 L, 34.1 L and 49.2 L).
- + Frame finishes: silver grey, chrome and anthracite.
- + Bin finishes: white and silver grey.
- + The one-bin model offers additional storage space, perfect for storing cleaning products or other items (see illustration).
- + Load capacity of up to 100 lb (45 kg).
- + Installation template included.
- + K-Waste can be fitted with a mechanical Push to Open device (#61015100, sold separately) for hands-free opening.



For wide frames featuring two bins, we recommend installing a cover exclusively on the front bin.



### Available configurations

#### Narrow frame:

1 x 28 qt (1 x 26,5 L) or 1 x 36 qt (1 x 34,1 L) or 1 x 52 qt (1 x 49,2 L)  
2 x 28 qt (2 x 26,5 L)

#### Wide frame:

2 x 36 qt (2 x 34,1 L) or 2 x 52 qt (2 x 49,2 L)



**A** Narrow K-Waste frame  
Available in 3 finishes: Anthracite, chrome or silver grey



**B** Wide K-Waste frame



**C** Bins:  
Available in 28 qt, 36 qt and 52 qt  
Available in two finishes: white and silver grey



**D**

\* For models with two bins (36 qt or 52 qt), install the cover on the front bin only.

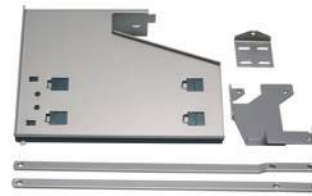

**F**

Automatic door opener (PTO) for K-Waste  
Available in 2 finishes: silver grey (61015100) and anthracite (61015906)

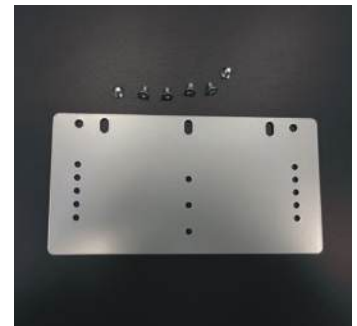

**G**

The K-Waste wide door holder is available as an optional accessory, ideal for doors wider than 21" (533 mm) and for framed (shaker-style) doors that are not 15" and 18". To complete your setup, be sure to order two.

### 1 Single or double frame

Fig.	Description	Silver grey	Chrome	Anthracite	Min. opening width for framed cabinets	Min. int. width for frameless cabinets	Min. int. depth
<b>A</b>	Single frame	61010100	61010140	61010906	11 1/2" (292 mm)	12 1/2" (318 mm)	min. 22 1/8" (562 mm)
<b>B</b>	Double frame	61020100	61020140	61020906	14 1/2" (368 mm)	15 1/2" (394 mm)	min. 22 1/8" (562 mm)

For required internal height, see table below.

### 2 Bins

Fig.	Description	Silver grey	Chrome	Required int. height without lid	Required int. height with lid
<b>C</b>	26.49 L (28 qt) bin	51025100	5102530	min. 19 1/2" (496 mm)	N/A
<b>C</b>	34.1 L (36 qt) bin	51212100	5101230	min. 19 1/2" (496 mm)	min. 20 1/2" (521 mm)
<b>C</b>	49.2 L (52 qt) bin	51052100	5105230	min. 23 1/2" (597 mm)	min. 24 1/2" (623 mm)

### 3 Optional accessories

Fig.	Code	Description	Product width	Product depth	Product height	Finish
<b>D</b>	51152100	Lid	14 1/2" (368 mm)	11" (279 mm)	1" (25 mm)	Silver grey
<b>D</b>	51152030	Lid	14 1/2" (368 mm)	11" (279 mm)	1" (25 mm)	White
<b>I</b>	61015100	PTO system				Silver grey
<b>I</b>	61015906	PTO system				Anthracite
<b>J</b>	25079100	System for wide doors (sold individually)				Silver grey



CLEANING PREPARATION

## Smart home: "Alexa" can you open the trash can.

*Libero 3.0* is an automatic hands-free opening system, featuring a foot-activated laser sensor and integration with Amazon's *Alexa*. It brings convenience and innovation to your kitchen experience, setting the standard for the future.



- + Two opening options available:  
A) foot-activated laser sensor  
B) voice activation with *Alexa*.
- + Designed for easy attachment to the bottom front of cabinets (not compatible with framed cabinets).
- + Powered via a standard 120V outlet with USB-C/USB cable and adapters included.
- + LED location lighting for added visibility.
- + Push force and laser sensitivity settings can be customized through online account settings.
- + Automatic opening function intelligently detects obstructions.
- + Splash-proof design with IP21 certification.
- + UL and CSA certified.
- + Compatible with cabinet doors ranging from 12" to 24" (300 to 600 mm) in width.
- + Works with any type of recycling center installed laterally in a frameless cabinet (#83614, #84614, #4719), and is also suitable for bottom deep drawers.



A Libero 3.0 smart door opener



B The Kick-and-Go pedal only works on Euro-Cargo II models without the cushioned closing device.

### Mechanical door opener (Kick-and-Go pedal)

Fig.	Type of waste bin	Recommended mechanism Code	Finish
B	83614100 - 8361460100	3695106	Grey
B	361430100	3694106	Grey



A

### Smart door opener

Fig.	Code	Description	Product dimensions (W x D x H)		
			Width	Depth	Height
A	36973100	Libero 3.0 smart door opening system	6 3/16" (157 mm)	11 3/4" (300 mm)	1 5/16" (33 mm)

# Modular and economical!



Product shown: Practico series



53000140, 873000140



56000140, 876000140



Sliding door version



15 L  
5303030, 53030100



35 L  
5603030, 56030100



Manual version



- + Practico offers a customizable recycling solution tailored to individual needs.
- + Easily adjust the frame to fit the available interior width by inserting the preferred container type.
- + Chrome metal frame with mounting brackets, suitable for door installation.
- + Accommodates two interior widths: minimum 10 1/4" (260 mm) or 20 1/16" (510 mm).
- + Choose from two container sizes: 15.8 or 36.9 qt (15 or 35 L).
- + Available in white or silver grey finishes.
- + Compatible with both hinged (manual opening) and door-mounted doors.
- + Enjoy full access with the help of full-extension runners.
- + Frames available with or without soft-close mechanism.

Available configurations:



A 2 x 15.8 qt (15 L)



B 1 x 36.9 qt (35 L)



C 4 x 15.8 qt (15 L)



D 2 x 36.9 qt (35 L)



E 1 x 36.9 qt + 2 x 15.8 qt  
(1 x 35 L + 2 x 15 L)

**For a complete system, please order:**

Fig.	Min. int. dimensions required	Quantity	Without Soft-close	With Soft-close	Description	Total capacity
	Width      Depth      Height					
A	10 1/4" (260 mm)      20 3/4" (528 mm)      20 1/16" (510 mm)	1	53000140	873000140	Chrome metal frame (small)	31.7 qt (30 L)
		2	53030XX		15.8 qt (15 L) container	
B	10 1/4" (260 mm)      20 3/4" (528 mm)      20 1/16" (510 mm)	1	53000140	873000140	Chrome metal frame (small)	36.9 qt (35 L)
		1	56030XX		36.9 qt (36 L) container	
C	20 1/16" (510 mm)      20 3/4" (528 mm)      20 1/16" (510 mm)	1	56000140	876000140	Chrome metal frame (large)	63.4 qt (60 L)
		4	53030XX		15.8 qt (15 L) container	
D	20 1/16" (510 mm)      20 3/4" (528 mm)      20 1/16" (510 mm)	1	56000140	876000140	Chrome metal frame (large)	73.9 qt (70 L)
		2	56030XX		36.9 qt (36 L) container	
E	20 1/16" (510 mm)      20 3/4" (528 mm)      20 1/16" (510 mm)	1	56000140	876000140	Chrome metal frame (large)	68.6 qt (65 L)
		2	53030XX		15.8 qt (15 L) container	
		1	56030XX		36.9 qt (36 L) container	

Choice of colors: XX = 30 for white and 100 for grey



CLEANING PREPARATION

# Turn your drawer into a recycling center!

*One2Five* is a recycling bin system designed to hang within a double-walled metal drawer like *Tandembox* and *Intivo*.

You can create your own bin configuration to suit your sorting requirements. With *One2Five*, you can perfectly match the interior of your cabinets with adjacent drawers.



- + *One2Five* comprises a suspended frame that fits within your existing drawer, accommodating bins of your choice.
- + Compatible with *Tandembox* and *Intivo* drawers (H: 3 9/32", W: 19 11/16") (H: 83 mm, W: 500 mm).
- + The frame includes a full-width internal cover, securing to the cabinet's two inner walls.
- + Optionally, it can be used with *Blum's Servo-Drive* system for assisted opening.
- + Individual lids for each bin can be ordered as an option, particularly practical for the 8 L version, ideal for compost management.
- + Each bin features handles for effortless removal from the frame.
- + When determining the required internal height, always consider the height of the tallest bin.



Product shown: Version for one cabinet 23 1/2" (600 mm) wide, 2 x 8.4 qt + 2 x 33.8 qt (2 x 8L + 2 x 32L)

Product shown: Version for one cabinet 17 3/4" (450 mm) wide, 2 x 33.8 qt (2 x 32L)

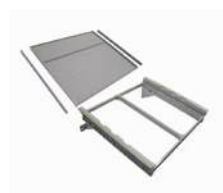

A



B



C



D

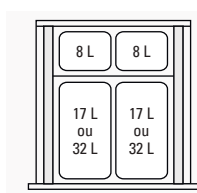

23 1/2" (600 mm) wide cabinet, 4 bins

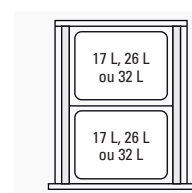

17 3/4" (450 mm) wide cabinet, 2 bins



See our available configurations at [richelieu.com](http://richelieu.com)



For exclusive use with frameless cabinets measuring 17 3/4" (450 mm) or 23 1/2" (600 mm) in outer width, featuring 5/8" (16 mm) thick cabinet walls. Internal depth required is the same as that for *Tandembox* and *Intivo* 19 11/16" (500 mm) drawer installation.

For a complete system: Order 1 frame + the required number of trays + options

Fig.	Code	Description	Min. int. width required
<b>Frame</b>			
A	5206100	Frame and lid for 450 cabinet, silver grey	16 1/2" (418 mm)
A	5216100	Frame and lid for 600 cabinet, silver grey	22 3/8" (568 mm)
<b>Bin</b>			
			<b>Min. int. height required</b>
B	5050100	8.4 qt (8 L) bin, silver grey	12 1/4" (310 mm)
B	5060100	17.9 qt (17 L) bin, silver grey	12 1/4" (310 mm)
B	5258100	26.4 qt (26 L) bin, silver grey	17 3/4" (450 mm)
B	5275100	33.8 qt (32 L) bin, silver grey	22 1/8" (560 mm)
<b>Options</b>			
C	5661100	Standard lid for 8 L (8.4 qt) bin, silver grey	
C	5662100	Standard lid for 17.9 qt (17 L), 26.4 qt (26 L) or 33.8 qt (32 L) bin, silver grey	
D	5003100	Lid with bio-filter for 8.4 qt (8 L) bin, silver grey	
E	52393100	<i>Servo-Drive Blum</i> 450	
E	Z10T543	<i>Servo-Drive Blum</i> 600	





Product shown: 2 x 37 qt (2 x 35 L) version for 23 1/2" (600 mm) wide cabinets

## The high-capacity solution for 600 mm cabinets



- + Each bin is equipped with handles for effortless removal.
- + For both 2 x 26.4 qt and 2 x 37 qt (2 x 25 L and 2 x 35 L) configurations, the compensating profile (sold separately) is necessary to fill the space at the rear of the frame.
- + The optional *Servo-Drive* provides electric assistance for door opening.
- + This version enables configurations with total capacities of 52.8 qt (50 L) (two bins of 26.4 qt) or 74 qt (70 L) (two bins of 37 qt) for 23 1/2" (600 mm) wide cabinets.
- + Compatible with *Tandembox* or *Intivo* drawers (H: 3 9/32" (83 mm), W: 19 3/4" (500 mm)).
- + The *Servo-Drive* product is only suitable for cabinets with 5/8" (16 mm) thick walls.



Interior depth required: same as for *Tandembox* 19 3/4" (500 mm) drawer installation

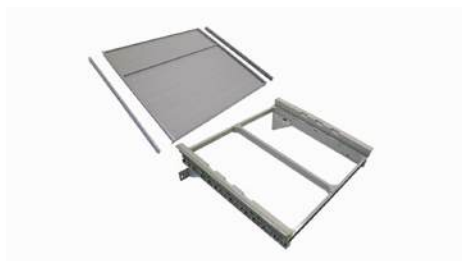

A



B



C



D

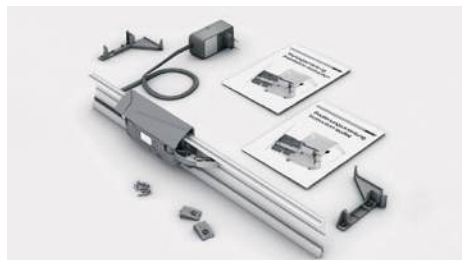

E



See our available configurations at [richelieu.com](http://richelieu.com)

**For a complete system: order 1 frame + 2 trays + options**

Fig.	Code	Description	Min. int. width required
<b>Frame</b>			
A	5216100	Frame and lid for 23 1/2" (600 mm) cabinet, silver grey	22 3/8" (568 mm)
<b>Compensating profile</b>			
B	5891100	Compensating profile	
<b>Bin</b>			
C	5061100	26.4 qt (25 L) bin, silver grey	Min. int. height required 13" (330 mm)
C	5062100	37 qt (35 L) bin, silver grey	18 1/2" (470 mm)
<b>Options</b>			
E	5010100	Standard lid for 26.4 qt (25 L) or 37 qt (35 L) bins, silver grey	
E	Z10T543	<i>Servo-Drive Blum</i> for 600	



CLEANING PREPARATION



Turn deep drawers into a recycling center or storage space in the blink of an eye. This system is the simplest solution on the market today.



- + Suitable for a variety of deep drawers, including those in kitchens and bathrooms, made of materials like melamine, wood, or metal.
- + Allows to choose the appropriate bin type, lid, and anti-slip mat based on drawer dimensions and available space.
- + The anti-slip mat features small pegs that securely hold the bins in place when the drawer is opened or closed.
- + Bins come with handles for perfect grip.
- + Easy to clean.
- + The bins are available in various heights and capacities.
- + Bins configuration with or without lids make them versatile for use as recycling or storage.



**For a complete system, please order:**

One anti-slip mat #5181100 (to be cut to your drawer dimensions), the number of bins according to drawer dimensions and storage requirements, plus one individual lid per bin (optional).

Visit [richelieu.com](http://richelieu.com) for configuration options.

Fig.	Code	Description	Product dimensions (W x D x H)			Capacity
			Width	Depth	Height	
A	5181100	Non-slip mat for <i>One2Four</i> system	46 1/2" (1,181 mm)	17 7/8" (600 mm)		
B	5135100	6.3 qt bin, silver grey	8 5/16" (211 mm)	5 9/16" (141 mm)	10 7/8" (275 mm)	6.3 qt (6 L)
B	5136100	14.3 qt bin, silver grey	11" (279 mm)	8 5/16" (211 mm)	10 7/8" (275 mm)	14.3 qt (13.5 L)
B	5137100	22.2 qt bin, silver grey	16 5/8" (423 mm)	8 5/16" (211 mm)	10 7/8" (275 mm)	22.2 qt (21 L)
C	5178100	4.4 qt bin, silver grey	6" (152 mm)	8 1/2" (230 mm)	9" (220 mm)	4.4 qt (4.2 L)
C	5175100	5.8 qt bin, silver grey	9 1/16" (230 mm)	6 1/32" (153 mm)	8 21/32" (220 mm)	5.8 qt (5.5 L)
C	5170100	12.7 qt bin, silver grey	12" (306 mm)	9 1/6" (230 mm)	8 21/32" (220 mm)	12.7 qt (12 L)
D	5661100	Covers for 5175100, 5178100	9 1/16" (230 mm)	5 29/32" (150 mm)	25/32" (20 mm)	
D	5662100	Covers for 5170100	11 3/8" (290 mm)	8 1/2" (216 mm)	25/32" (20 mm)	
E	5670100	Covers for 5135100	5 9/16" (141 mm)	8 5/16" (211 mm)	25/32" (20 mm)	
E	5671100	Covers for 5136100	8 5/16" (211 mm)	11 1/8" (282 mm)	25/32" (20 mm)	
E	5672100	Covers for 5137100	8 5/16" (211 mm)	16 5/8" (423 mm)	25/32" (20 mm)	
F	5003100	Bio lids for 4.4 qt and 5.8 qt bins	6 1/16" (154 mm)	9 1/32" (229 mm)	1 31/32" (50 mm)	
G	5007100	Replacement filter for <i>Bio</i> lid				



Product shown: 23 1/2" (600 mm) cabinet system, 2 x 37 qt (35 L)



Product shown: 17 3/4" (450 mm) cabinet system, 1 x 44.4 qt (42 L)

**One2Seven:** This modular recycling center for *Legrabox* drawers from *Blum* lets you customize waste management to suit your needs.



- + Compatible with Blum's *Legrabox* drawers measuring 21 5/8" (550 mm) deep and C-height (sold separately).
- + These systems are available for outside width of 17 1/2" (450 mm) and 23 1/2" (600 mm) pedestals, with side panel thickness of 5/8" (16 mm).
- + The fixed inner lid (sold separately) helps contain odors and increases storage capacity.
- + Bins are available in.
- + Various configuration options:
  - For 15 3/4" (400 mm) cabinets: 1 x 37 qt (35 L) or 1 x 44.4 qt (42 L)
  - For 23 1/2" (600 mm) cabinets: 2 x 37 qt (35 L) or 2 x 44.4 qt (42 L).
- + Provides a combined capacity of up to 88.8 qt (84 L) for 23 1/2" (600 mm) wide cabinets.
- + Each bin is equipped with handles for convenient removal and handling.
- + The folded handles keep the bags securely in place.
- + Individual bin lids are available and compatible with both 37 and 44.4 qt (35 L and 42 L) bins.
- + **Biobin** compost bin (sold separately) can be attached inside one of the bins, allowing for a two or three-bin system.
- + Stylish Orion grey finish.

**For a complete system, please order:**



One *Legrabox* drawer, nominal length of 21 5/8" (550 mm) and C height of 7" (177 mm), one *One2Seven* frame, one internal lid and the required number of 37 or 44.4 qt (35 L or 42 L) bins, depending on your needs.



A



B



C



D



E Lid for 37 or 44.4 qt (35 or 42 L) bin (optional).



F Optional compost bin in dark grey and silver grey (lid included)

Fig.	Code	Description	Product dimensions (W x D x H)			Capacity
			Width	Depth	Height	
A	WEBKIT1211412	<i>Legrabox</i> drawer		21 5/8" (550 mm)	C-7" (177 mm)	
B	604516910	<i>One2Seven</i> 450 frame	15 3/4" (400 mm)	min. 21 5/8" (550 mm)		
B	606016910	<i>One2Seven</i> 600 frame	21 5/8" (550 mm)	min. 21 5/8" (550 mm)		
C	514516910	<i>One2Seven</i> 450 inside lid	16 1/2" (418 mm)	21 5/8" (550 mm)	31/32" (25 mm)	
C	516016910	<i>One2Seven</i> 600 inside lid	22 3/8" (568 mm)	21 5/8" (550 mm)	31/32" (25 mm)	
D	5062910	35 L bin for <i>One2Seven</i> system	16 1/4" (412 mm)	9 1/16" (230 mm)	18 1/2" (470 mm)	37 qt (35 L)
D	5074910	42 L bin for <i>One2Seven</i> system	16 1/4" (412 mm)	9 1/16" (230 mm)	22" (560 mm)	44.4 qt (42 L)
E	50101910	Lids for <i>One2Seven</i> bins	9 1/16" (230 mm)	16 1/4" (412 mm)	25/32" (20 mm)	
F	518890910	<i>Biobin</i> compost bin, dark grey	8 15/16" (227 mm)	6 1/2" (165 mm)	6 11/16" (170 mm)	4.4 qt (4.2 L)
F	518890100	<i>Biobin</i> compost bin, dark grey	8 15/16" (227 mm)	6 1/2" (165 mm)	6 11/16" (170 mm)	4.4 qt (4.2 L)



Trigon

## Unparalleled accessibility

Corner cupboards are often underused. Transform these forgotten spaces into storage paradise with our corner systems and accessories.



*Lemans II*



*Power Slide*



*Magic Corner*



*Magic Corner II*

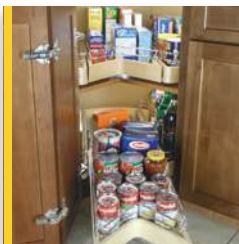

*Two-tray system with drawer*

<i>Qanto</i> electric lift-up system	98
Set of two <i>Arena</i> trays for <i>Lemans II</i> blind corner cabinet	100
Two- and three-tray system for <i>Trigon</i> blind corner cabinet	102
<i>Power Slide</i> sliding and swivelling shelves system	104
<i>Revo</i> and <i>Pro-Arc</i> swivel trays	105
<i>Magic Corner Fiore</i> and <i>Magic Corner II Fiore</i> blind corner system	106
<i>Magic Corner</i> door-mounted blind corner system	107
<i>Magic Corner II</i> blind corner system with hinged doors	108
<i>Smart Corner III</i> blind corner system with hinged doors	109
<i>Lazy Susan</i> swivelling trays	110



FOOD STORAGE STORAGE PREPARATION

## CORNER CABINETS

## QANTO ELECTRIC LIFT-UP SYSTEM FOR BLIND CORNER

# Unlock the potential of vertical storage

### Qanto electric blind corner lift-up system

Qanto is a pre-assembled electric lift-up system, offering the ultimate solution for maximizing storage space in corner and end cabinets.



- + The Qanto is a two-tray electric lift system pre-assembled in a base cabinet.
- + Ideal for storing small appliances like coffee machines and stand mixers, as well as cookware, or for crafting a hidden bar, or to create a concealed bar.
- + Equipped with integrated LED lighting beneath the top shelf.
- + A safety device automatically halts shelf descent in case of obstruction.
- + Qanto units are equipped with leveling feet for precise height adjustment.
- + Features removable trays for easy cleaning.
- + This product is UL and CSA Certified.
- + Qanto features a load capacity of 22 lb (10 kg) for the top tray and 33 lb (15 kg) for the bottom tray.



A For corner application



The two models are pre-assembled in a box ready to install and connect.



The two shelves ascend and descend with simple press of a button.

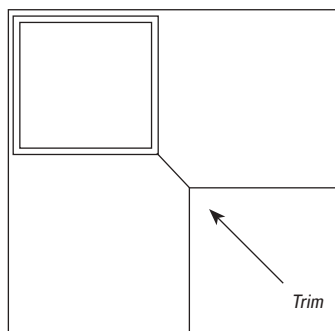

Corner model 57011910



Fig.	Code	Description	Cabinet dimensions (W x D x H)		Height	Load capacity total recommended	Finish
			Width	Depth			
A	57011910	Qanto for corner	22 13/16" (580 mm)	22 13/16" (580 mm)	31 1/2" to 39 3/4" (800 to 1,010 mm)	55 lb (25 kg)	Dark grey

**QANTO ELECTRIC LIFT-UP SYSTEM FOR ISLAND**

**CORNER CABINETS**



FOOD STORAGE STORAGE PREPARATION

*Simply connect and use*



**Qanto electric island lift-up system**  
Pre-assembled, this innovative system can also be integrated into a kitchen island to enhance dynamic storage space.

**B** Island model 57014910



Closed system



Open system

Fig.	Code	Description	Cabinet dimensions (W x D x H)		Height	Load capacity total recommended	Finish
			Width	Depth			
<b>B</b>	57014910	Qanto for island	22 13/16" (580 mm)	22 13/16" (580 mm)	31 1/2" to 39 3/4" (800 to 1,010 mm)	55 lb (25 kg)	Dark grey



FOOD STORAGE STORAGE PREPARATION

## CORNER CABINETS

## SET OF TWO ARENA TRAYS FOR LEMANS II BLIND CORNER



Product shown: anthracite/anthracite version with stylish contour (flat rail), left-hand opening



Product shown: grey/chrome version with classic round wire contour

*The original version: often replicated, yet never matched.*

Inspired by the shape of the iconic *Le Mans* racing circuit, this tray system has redefined accessibility in blind corner cabinets. It blends an elegant, contemporary design with easy access to often neglected corner spaces. Our patented four-arm hinge system, along with the optional soft-close mechanism and *Arena* trays, ensures smooth operation while securely organizing items in place.



The set includes a mechanism and two *Arena* trays.



- + Easy to order and install.
- + Open the door, then pull out each tray independently.
- + The height-adjustable trays feature a non-slip coating and a metal contour.
- + Available in several finishes: maple/chrome, grey/chrome, anthracite/anthracite.
- + Trays fully extend with a door opening of only 85 degrees.
- + Suitable for both left and right-hand openings.
- + Optional soft-close feature.
- + Two contour options available: classic round wire for grey/chrome and maple/chrome finishes, and flat rail style model for anthracite/anthracite finish.
- + Load capacity of 55 lb (25 kg) per tray.



**Min. int. depth required:**  
19 5/8" (500 mm)

**Min. int. height required:**  
21 1/2" (545 mm)

Visit our website to confirm the minimum door opening required.

### Complete set with two trays

Description	Opening	Min. int. width required	Maple/chrome	Grey/chrome	Anthracite/anthracite
<i>LeMans II</i> 400 set	Right	30 3/4" (780 mm)	6936140150	6936140100	6936906906
<i>LeMans II</i> 400 set	Left	30 3/4" (780 mm)	6937140150	6937140100	6937906906
<i>LeMans II</i> 450 set	Right	32 1/4" (820 mm)	6930140150	6930140100	6930906906
<i>LeMans II</i> 450 set	Left	32 1/4" (820 mm)	6931140150	6931140100	6931906906
<i>LeMans II</i> 500 set	Right	36 1/4" (920 mm)	6932140150	6932140100	6932906906
<i>LeMans II</i> 500 set	Left	36 1/4" (920 mm)	6933140150	6933140100	6933906906
<i>LeMans II</i> 600 set	Right	38" (965 mm)	6934140150	6934140100	6934906906
<i>LeMans II</i> 600 set	Left	38" (965 mm)	6935140150	6935140100	6935906906



# SETS OF TWO ARENA TRAYS FOR LEMANS II BLIND CORNER

## CORNER CABINETS



Anthracite/anthracite with style model rail, right-hand opening



Chrome/grey with classic model rail, right-hand opening



Chrome/maple with classic model rail, right-hand opening



Min. int. height required:  
49 7/8" (1,265 mm)

### Accessories (optional)

Fig.	Code	Description	Opening	Finish
A*	693802100	Soft-close mechanism	Right	Grey
A*	693803100	Soft-close mechanism	Left	Grey
A*	693802906	Soft-close mechanism	Right	Anthracite
A*	693803906	Soft-close mechanism	Left	Anthracite
B	693630	Opening restriction device		Champagne
C	6930100	Spacers for face framed cabinets		Grey
D	2504100	Hardware for 4 shelf system		Grey

\* Sold as a set of two soft-close mechanism.



Product shown: four-tray application using four-tray hardware #2504100 and two sets of two trays



A 693802100, 693803100, 693802906, 693803906  
Soft-close mechanism



B 693630  
Opening restriction device



C 6930100  
Spacer for framed cabinet



D 2504100  
Four-shelf hardware



FOOD STORAGE STORAGE PREPARATION

## CORNER CABINETS

## TWO AND THREE-TRAY SYSTEM FOR *TRIGON* CORNER CABINETS



*Trigon I* - two trays, left-hand version

*Trigon* revolutionizes corner cabinet storage with the introduction of an optional third tray—a market first, ensuring maximum use of available space.

## Reinvent corner cabinet storage with *Trigon*



- + *Trigon* is available in two different configurations: *Trigon I-450*, optimized for standard dead-corner cabinets with a 18" (450 mm) door, and *Trigon II-600*, designed for 90-degree corner double cabinets featuring a 24" (600 mm) door. *Trigon II* is versatile, suitable for standard dead-corner cabinets as well.
- + *Trigon II-600* (24") is exclusively compatible with double cabinet installations, requiring the construction of two specific cabinets.
- + Suitable for both framed and frameless cabinets.
- + An optional third tray is available, boosting cabinet storage capacity by 50%.
- + Each tray has a weight capacity of 55 lb (25 kg) and comes out of the cabinet individually.
- + Tray height adjustment is effortless and tool-free.
- + Made from 100% recyclable materials.
- + Quick to install.
- + Easy to clean.
- + An optional dampened closure feature is available (sold individually).
- + Features a stylish dark grey finish.
- + Tray surfaces are scratch-resistant.
- + *Trigon I* and *II* trays have different shapes (see drawing below).

**Standard blind spot application**  
***Trigon I-450* (A)**  
18" (450 mm) tray shape

**Double corner – 90° application**  
***Trigon II-600* (B)**  
24" (600 mm) tray shape

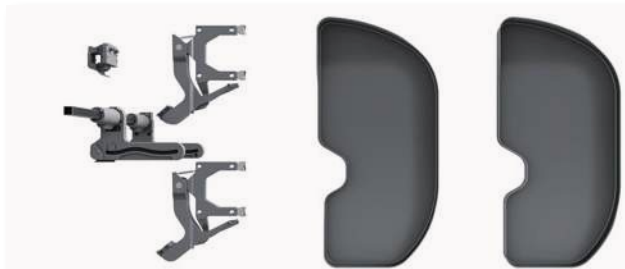

One set includes two trays and a mechanism.



Left-hand version shown

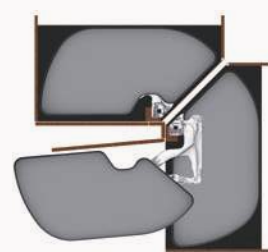

For the double corner version, order two sets (one right-hand and one left-hand).



Forward movement prevents interference with adjacent appliances or cabinets.



Quick installation and tool-free tray height adjustment.



## 2 AND 3-TRAY SYSTEM FOR TRIGON CORNER CABINET

## CORNER CABINETS



### EASY TO ORDER

1

Order a set of two trays.

2

Order one or more optional accessories.



Trigon I-450 mm, right-hand version, "standard" blind corner cabinet



Trigon II-600 mm, 90° double cabinets  
Credit: Beeck-Kuechen.

### 1 Order a set of two trays. Make a selection between a right-hand or a left-hand version.

Fig.	Code	Description	Min. int. dimensions required (W x D x H)			Door opening required	Finish
			Width	Depth	Height		
A	62414503910	Trigon I-450 left	33 15/16" (862 mm)	20 1/16" (510 mm)	28 1/2" (724 mm)	16 1/4" (412 mm)	Dark grey
A	62424502910	Trigon I-450 right	33 15/16" (862 mm)	20 1/16" (510 mm)	28 1/2" (724 mm)	16 1/4" (412 mm)	Dark grey
B*	62516203910	Trigon II-600 left	37 7/8" (962 mm)	20 1/16" (510 mm)	28 1/2" (724 mm)	22 1/8" (562 mm)	Dark grey
B*	62526202910	Trigon II-600 right	37 7/8" (962 mm)	20 1/16" (510 mm)	28 1/2" (724 mm)	22 1/8" (562 mm)	Dark grey



\* For a 90 degree double corner application, order one left-hand opening version + one right-hand opening version. The double version is exclusively compatible with Trigon II-600.

### 2 Optional accessories

Fig.	Code	Description	Notes	Finish
A	62414513910	3 <sup>rd</sup> optional 450 tray, left (by unit)	For use with Trigon I, left only	Dark grey
A	62424512910	3 <sup>rd</sup> optional 450 tray, right (by unit)	For use with Trigon I, right only	Dark grey
B	62526013910	3 <sup>rd</sup> optional 600 tray, left (by unit)	For use with Trigon II, left only	Dark grey
B	62526012910	3 <sup>rd</sup> optional 600 tray, right (by unit)	For use with Trigon II, right only	Dark grey
C	62610390	Soft-close mechanism – left	Order 1 mechanism per tray	Dark grey
C	62620290	Soft-close mechanism – right	Order 1 mechanism per tray	Dark grey



FOOD STORAGE STORAGE PREPARATION

# Innovation comes from within

Power Slide represents the latest innovative solution for corner cabinets, embodying a perfect harmony between design and functionality. This system consists of two unique trays that slide individually.

The linear motion, aligned with the door, ensures complete accessibility and prevents potential interference with nearby appliances.



- + Two sliding trays ensure complete access to the cabinet interior.
- + The ergonomic design maximizes storage space.
- + An integrated contour enhances overall stability.
- + Trays slide and rotate 90°, preventing interference with adjacent cabinets or appliances.
- + Central mounting offers less space restriction, suitable for both framed and frameless cabinets, with the mechanism discreetly integrated for minimal visibility.
- + Easy assembly and cleaning: each tray can be effortlessly removed and replaced without the need for tools.
- + Individual sliding trays offer better ergonomics.
- + Tray construction supports a high load capacity of up to 20 kg per tray (44 lb).



Product shown: right-hand opening, dark grey



Anti-slip coating on silver grey version only



Removable trays for easy cleaning



Fig.	Code	Description	Opening	Min. door opening width	Min. int. dimensions required (W x D x H)			Finish
				Width	Depth	Height		
A	9591100	Power Slide 450 mechanism	Left	16 1/4" (412 mm)	33 7/8" (862 mm)	18 7/8" (480 mm)	24 3/8" (620 mm)	Silver grey
A	9592100	Power Slide 450 mechanism	Right	16 1/4" (412 mm)	33 7/8" (862 mm)	18 7/8" (480 mm)	24 3/8" (620 mm)	Silver grey
A	9595100	Power Slide 600 mechanism	Left	22 1/8" (562 mm)	45 3/4" (1,162 mm)	19 1/4" (490 mm)	24 3/8" (620 mm)	Silver grey
A	9596100	Power Slide 600 mechanism	Right	22 1/8" (562 mm)	45 3/4" (1,162 mm)	19 1/4" (490 mm)	24 3/8" (620 mm)	Silver grey
B	9591910	Power Slide 450 mechanism	Left	16 1/4" (412 mm)	33 7/8" (862 mm)	18 7/8" (480 mm)	24 3/8" (620 mm)	Silver grey
B	9592910	Power Slide 450 mechanism	Right	16 1/4" (412 mm)	33 7/8" (862 mm)	18 7/8" (480 mm)	24 3/8" (620 mm)	Silver grey
B	9595910	Power Slide 600 mechanism	Left	22 1/8" (562 mm)	45 3/4" (1,162 mm)	19 1/4" (490 mm)	24 3/8" (620 mm)	Silver grey
B	9596910	Power Slide 600 mechanism	Right	22 1/8" (562 mm)	45 3/4" (1,162 mm)	19 1/4" (490 mm)	24 3/8" (620 mm)	Silver grey



Two shelves per set



B



C

**Revo**

With a single motion, the doors, directly affixed to the mechanism, fold inward and vanish into the cabinet.



- + No need to go around the door to access storage space.
- + Easy installation with adjustable post, ranging from 26" to 33 13/16" (660 to 860 mm).
- + Features a non-slip grey melamine coating and chrome trim.
- + Height-adjustable trays.



**For a 35 1/2" x 35 1/2" (900 x 900 mm) cabinet**

Min. int. dimensions required:

Height: 26" to 33 13/16" (660 to 860 mm)

Interior diameter: 32 1/2" (825 mm)

**For a 31 1/2" x 31 1/2" (800 x 800 mm) cabinet**

Min. int. dimensions required:

Height: 26" to 33 13/16" (660 to 860 mm)

Interior diameter: 28 1/2" (725 mm)

**For a complete system, order mechanism (A) and 1 set of trays (B or C).**

Fig.	Code	Description	Product dimensions	Finish
A	6940100	Revo mechanism	Height: 26" to 33 13/16" (660 to 860 mm)	Silver grey
B	6763140100	Set of 2 – 31 13/16" (810 mm) trays	Diameter: 31 13/16" (810 mm)	Grey/chrome
B	6762140100	Set of 2 – 28" (710 mm) trays	Diameter: 28" (710 mm)	Grey/chrome
C	6763140150	Set of 2 – 31 13/16" (810 mm) trays	Diameter: 31 13/16" (810 mm)	Maple/chrome
C	6762140150	Set of 2 – 28" (710 mm) trays	Diameter: 28" (710 mm)	Maple/chrome

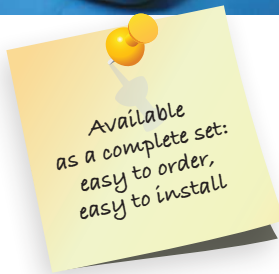

**Pro-Arc**



- + Ergonomically designed trays provide optimal storage space.
- + Each tray features a non-slip surface to ensure maximum stability.
- + The load capacity of each tray is 44 lb (20 kg).
- + Simple installation process.
- + The package includes two trays, one post, and installation hardware.
- + Compatible with doors equipped with standard hinges.

Code	Description	Product dimensions	Finish
9766100	Set of 2 – 3/4 Pro-Arc trays	28" (710 mm)	Silver grey
9776100	Set of 2 – 3/4 Pro-Arc trays	31 7/8" (810 mm)	Silver grey



FOOD STORAGE STORAGE PREPARATION

## CORNER CABINETS

## MAGIC CORNER FIORO AND MAGIC CORNER II FIORO SYSTEM FOR BLIND CORNER

# Streamlined and sophisticated solution

Winner of several international design awards, the *Fioro* product line represents the perfect marriage of wood and metal. The warmth and naturalness of wood combined with the elegance of anthracite metal add an exceptional touch to your interior design.



Product shown: *Magic Corner Fioro*, left-hand opening



A

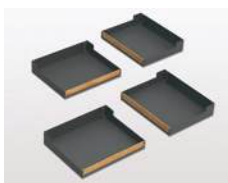

B



Product shown: *Magic Corner II Fioro*, right-hand opening



C

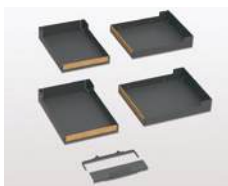

D



### *Magic Corner Fioro* (sliding door model)

- + Upon opening, the front baskets extend and swivel outward from the cabinet, while the rear baskets slide inward, for easy access in one smooth motion.
- + This system is designed for blind corner and door-mounted cabinets.
- + Offers the option for right or left-hand opening.
- + The metal shelves feature oak wood inserts and non-slip matting.
- + Includes an integrated soft-close mechanism.
- + This product is available in dark grey and natural oak finishes.



### *Magic Corner Fioro*

**Load capacity per basket:**  
Front: 15.4 lb (7 kg)  
Rear: 19.8 lb (9 kg)

### *Magic Corner II Fioro*

**Load capacity per basket:**  
Front: 22 lb (10 kg)  
Rear: 17 lb (7 kg)



### *Magic Corner II Fioro* (hinged door version)

- + Upon opening the door, the front baskets can slide fully forward, while the rear baskets can be pulled out individually for full access.
- + Features an ergonomic, height-adjustable handle.
- + This system is designed for blind corner cabinets with hinged doors.
- + Offers the option for right or left-hand opening.
- + The shelves are easy to remove for effortless cleaning.
- + Includes an integrated soft-close mechanism.
- + The metal shelves feature oak wood inserts and non-slip matting.
- + This product is available in dark grey and natural oak finishes.

**For a complete system, order: 1 frame + 1 set of shelves**

Fig. Code	Description	Opening	Int. dim. required
<b>Magic Corner – Sliding door installation</b>			
A	30826906 <i>Magic Corner Fioro</i> frame	Left	D = min. 21 1/4" (540 mm)
A	30831906 <i>Magic Corner Fioro</i> frame	Right	W = 33 7/8" to 38 1/4" (862 to 971 mm)
B	31010906 Set of 4 <i>Magic Corner Fioro</i> shelves		Door opening = 15 9/16" (395 mm)
<b>Magic Corner II – Hinged door installation</b>			
C	30580906 <i>Magic Corner II Fioro 900</i> frame	Right	
C	30582906 <i>Magic Corner II Fioro 1,000</i> frame	Right	
C	30581906 <i>Magic Corner II Fioro 900</i> frame	Left	
C	30583906 <i>Magic Corner II Fioro 1,000</i> frame	Left	
D	31007906 Set of 4 <i>Magic Corner II Fioro 450</i> shelves		15 9/16" (395 mm) opening
D	31008906 Set of 4 <i>Magic Corner II Fioro 500</i> shelves		17 1/2" (444 mm) opening
D	31009906 Set of 4 <i>Magic Corner II Fioro 550/600</i> shelves		19 7/16" (494 mm) opening



***Magic Corner II Fioro***  
**Min. int. dimensions required  
for installation (W x D x H)**

#### W (min. int. width):

33 7/8" to 38 1/4" (862 to 971 mm) if frame 30580906 or 30581906 with shelves 31007906 or 31008906

37 7/8" to 46 1/8" (962 to 1,171 mm) if frame 30582906 or 30583906 with shelves 31008906

37 1/4" to 38 1/4" (945 to 971 mm) if frame 30580906 or 30581906 with shelves 31009906

37 7/8" to 46 1/8" (962 to 1,171 mm) if frame 30582906 or 30583906 with shelves 31009906

**D (min. int. depth):** 19 11/16" (500 mm)

**H (min. int. height):** 21 1/2" (545 mm)

# MAGIC CORNER SYSTEM FOR DOOR-MOUNTED BLIND CORNER

## CORNER CABINETS



Product shown: right-hand opening, chrome/maple

The storage module fully extends from the cabinet, providing easy and ergonomic access.



- + Upon opening the door, the front baskets extend and swivel outward from the cabinet, while the rear baskets smoothly slide inward towards the opening, ensuring a full access in one seamless motion.
- + This system offers an extensive selection of baskets:
  - Chrome finish, offering both elegance and transparency.
  - *Arena* baskets available in grey melamine or maple, featuring a non-slip surface and chrome contour.
- + No tools are required for door adjustments.
- + Door fastening system allows for tool-free adjustments.
- + Features a *SoftStopp* soft-close mechanism.
- + An optional soft-close mechanism for installation at the top of the frame is also available for added comfort.

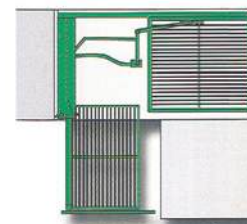

A Left-hand opening

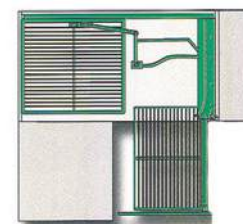

B Right-hand opening



C 6107140

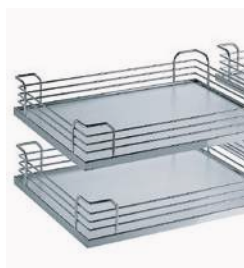

D 6107140100

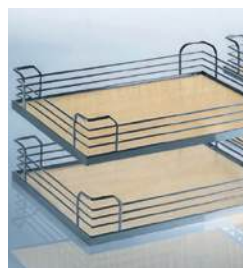

E 6107140150



F



### Min. int. dimensions required for installation (W x D x H)

W (min. int. width):	33 7/8 - 38 3/16" (860 to 970 mm)
D (min. int. depth):	19 11/16" (500 mm)
H (min. int. height):	21 1/4" (540 mm)
Min. opening width:	17 3/4" (450 mm)
Max. capacity (front):	30 lb (14 kg)
Max. capacity (corner):	40 lb (18 kg)

For a complete system, order: 1 frame + 1 set of shelves + 1 shock absorber (optional)

Fig.	Code	Product dimensions	Opening
A	16104100	Magic Corner frame, silver grey	Left
B	16103100	Magic Corner frame, silver grey	Right
C	6107140	Set of 4 Magic Corner shelves, chrome wire	
D	6107140100	Set of 4 Arena shelves, grey/chrome	
E	6107140150	Set of 4 Arena shelves, maple/chrome	
F	016211100	Soft-close mechanism	



FOOD STORAGE STORAGE PREPARATION

## CORNER CABINETS

## MAGIC CORNER II SYSTEM FOR HINGED-DOOR BLIND CORNER



Product shown:  
Magic Corner II, right-hand opening, silver/chrome grey



A



B



C

This system allows the entire contents of your corner cabinet to the outside. The ergonomic pull-out technology ensures full access to both front and rear baskets.



- + Once the door is open, the front baskets slide completely outward, and the rear baskets can be individually pulled forward.
- + Arena baskets feature a non-slip surface to secure pots, pans, and groceries in place.
- + Includes an ergonomic, height-adjustable handle.
- + Features a door stopper that hooks onto the basket rail to prevent accidental scratches when pulling forward.
- + This system is designed for installation in cabinets with hinged doors.
- + Integrated soft-close mechanism.



Arena anti-slip baskets



Door stopper to prevent accidental scratching



### Min. int. dimensions required for installation (W x D x H)

#### W (int. width):

33 7/8" to 38 1/4" (862 to 971 mm) if frame 30580100 or 30581100 with baskets 30595140-100,150 or 30594140100

37 7/8" to 46 1/8" (962 to 1,171 mm) if frame 30392100 or 30393100 with baskets 30595140100 or 30595140150

37 1/4" to 38 1/4" (945 to 971 mm) if frame 30580100 or 30581100 with baskets 30427140100 or 30427140150

37 7/8" to 46 1/8" (962 to 1,171 mm) if frame 30392100 or 30393100 with baskets 30427140100 or 30427140150

**Max. capacity:** 22 lb (10 kg) per basket, 44 lb (20 kg) for both 2 baskets (front and corner)

**D (min. int. depth):** 19 11/16" (500 mm)

**H (min. int. height):** 21 1/2" (545 mm)

#### Min. opening required:

15 1/2" (394 mm) if with baskets 30594140100

17 1/2" (444 mm) if with baskets 30595140100 or 30595140150

19 1/2" (494 mm) if with baskets 30427140100 or 30427140150



Height-adjustable basket and handle

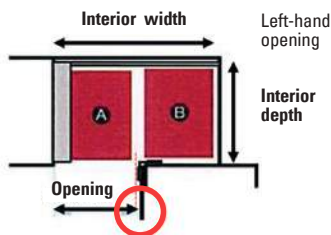

**For a complete system, order: 1 frame + 1 set of baskets**

Fig.	Code	Product dimensions	Opening	Finish
A	30580100	Magic Corner II frame, 900	Right	Silver grey
A	30581100	Magic Corner II frame, 900	Left	Silver grey
A	30392100	Magic Corner II frame, 1,100	Right	Silver grey
A	30393100	Magic Corner II frame, 1,100	Left	Silver grey
B	30594140100	Set of 4 baskets for door of 450, 2 Arena baskets and 2 chrome-plated wire baskets		Grey/chrome
C	30595140100	Set of 4 baskets for door of 500, 2 Arena baskets and 2 chrome-plated wire baskets		Grey/chrome
C	30595140150	Set of 4 baskets Arena for door of 500		Maple/chrome
C	30427140100	Set of 4 baskets Arena for door of 550/600		Grey/chrome
C	30427140150	Set of 4 baskets Arena for door of 550/600		Maple/chrome



## The handy pick

The *Smart Corner III* is the perfect solution for corner cabinet storage. With a single choice of chrome wire baskets, this is a simplified system that blends well with any kitchen style.



- + Easy assembly in minutes.
- + Improved stability and compatibility with doors up to 23 5/8" (600 mm) wide, thanks to wide door brackets.
- + Full-extension runners with a soft-closing mechanism.
- + Total load capacity of 77 lb (35 kg).
- + Easy adjustment of opening angle using a simple screw mechanism.
- + Secure attachment of baskets with basket hooks.
- + Set of four chrome-plated wire baskets available (sold separately).



203502100  
Product shown: *Smart Corner III*, right-hand opening (with basket set #2053140)



2053140  
Set of four baskets (two front and two rear)



Drilling template included for easy installation



**Min. door opening width required:**  
16 1/8" (410 mm)

Code	Description	Opening	Finish	Int. required dimensions (W x D x H)		
				Width	Depth	Height
203502100	<i>Smart Corner III</i> frame	Right	Grey	33 7/8" to 46" (860 to 1,168 mm)	18 1/2" to 19 7/8" (470 to 505 mm)	22" (560 mm)
203503100	<i>Smart Corner III</i> frame	Left	Grey	33 7/8" to 46" (860 to 1,168 mm)	18 1/2" to 19 7/8" (470 to 505 mm)	22" (560 mm)
2053140	Set of 4 <i>Smart Corner III</i> shelves		Chrome			



FOOD STORAGE STORAGE PREPARATION

## CORNER CABINETS

## LAZY SUSAN SWIVELLING TRAYS

*Well-liked, functional  
and always trusted!*



- + Height-adjustable post with a sleek chrome finish.
- + Each tray pivots independently, and the top tray is height-adjustable for easy access.
- + Trays feature a non-slip coating available in silver grey or maple melamine, with chrome trim.
- + Diameters provide ample storage capacity.
- + Each tray has a load capacity of 44 lb (20 kg).

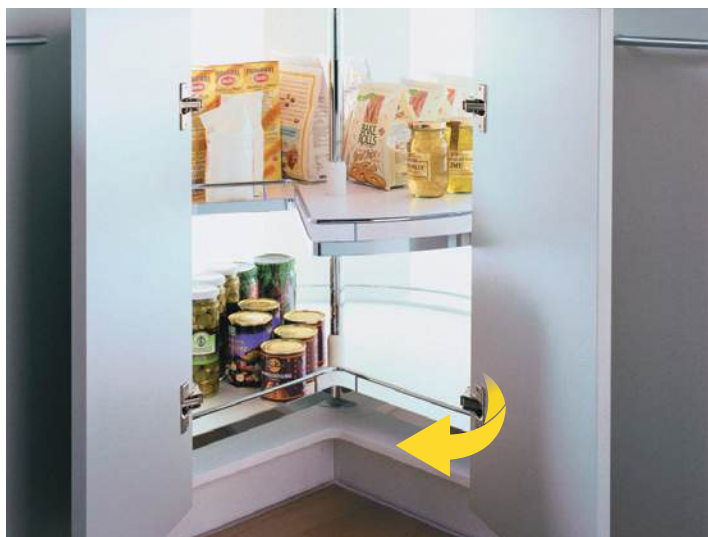

**A** 671024140100 and 671124140100, silver grey finish



**B** 671024140150 and 671124140150, maple finish



Arena trays with non-slip coating

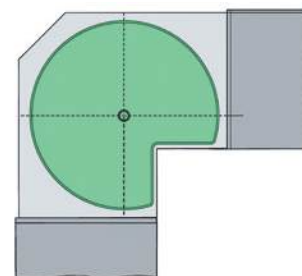

Fig.	Code	Description	Finish	Tray diameter	Int. height required
A	671024140100	Set of 2 – 3/4 pivoting trays	Chrome pole, silver grey/chrome tray	27 1/2" (700 mm)	28 9/16" to 30 1/8" (725 to 765 mm)
A	671124142100	Set of 2 – 3/4 pivoting trays	Chrome pole, silver grey/chrome tray	32 1/4" (820 mm)	28 9/16" to 30 1/8" (725 to 765 mm)
B	671024142150	Set of 2 – 3/4 pivoting trays	Chrome pole, maple/chrome tray	27 1/2" (700 mm)	28 9/16" to 30 1/8" (725 to 765 mm)
B	671124140150	Set of 2 – 3/4 pivoting trays	Chrome pole, maple/chrome tray	32 1/4" (820 mm)	28 9/16" to 30 1/8" (725 to 765 mm)

## Wood, a natural choice

A return to nature, even in the choice of kitchen accessories. Discover Richelieu's complete range of maple swivel trays.



A 74182151

B 74183151



- + Bring the inviting warmth of maple into your kitchen.
- + Height-adjustable pole adapt to any cabinet style.
- + Independently pivoting trays for easy access.
- + Tray are manufactured in durable maple-finish plywood top.
- + Features a 1" (25 mm) high contour.
- + Secure items in place.
- + Varnished trays offer durability and resistance to wear.
- + Adding an optional #4711015011 anti-slip mat prevents items from sliding and improves protection.



C 84242151 / 84282151 / 84322151

D 79202151 and 79312151



E 4711015011

Fig.	Code	Description	Finish	Tray diameter	Int. height required
A	74182151	Set of 2 – round trays	Maple	18" (458 mm)	25 5/8" to 32" (651 to 813 mm)
B	74183151	Set of 3 – round trays	Maple	18" (458 mm)	33 5/8" to 40" (853 to 1,016 mm)
C	84242151	Set of 2 – 3/4 trays	Maple	24" (610 mm)	26" to 32" (660 to 813 mm)
C	84282151	Set of 2 – 3/4 trays	Maple	28" (712 mm)	26" to 32" (660 to 813 mm)
C	84322151	Set of 2 – 3/4 trays	Maple	32" (813 mm)	26" to 32" (660 to 813 mm)
D	79202151	Set of 2 – D-shape trays	Maple	20" (508 mm)	25 5/8" to 32" (651 to 813 mm)
D	79312151	Set of 2 – D-shape trays	Maple	31" (788 mm)	25 5/8" to 32" (651 to 813 mm)
E	4711015011	Non-slip mat	Translucent	Dimensions: 43 1/4" x 59" (1,100 x 1,500 mm)	



FOOD STORAGE STORAGE PREPARATION

## CORNER CABINETS

## LAZY SUSAN WOOD SWIVELLING TRAYS

The trays are fitted with a ball-bearing pivot.



A 7218151



B 8224151 / 8228151 / 8232151

Fig.	Code	Description	Finish	Tray diameter	Min. int. height required
A	7218151	Set of 2 round swiveling trays	Maple	18" (458 mm)	2" (50 mm) + tray content
B	8224151	Set of 2 – 3/4 swiveling trays	Maple	24" (610 mm)	2" (50 mm) + tray content
B	8228151	Set of 2 – 3/4 swiveling trays	Maple	28" (712 mm)	2" (50 mm) + tray content
B	8232151	Set of 2 – 3/4 swiveling trays	Maple	32" (813 mm)	2" (50 mm) + tray content



A 87301250  
Complete set with two trays



B 87301150  
Application shown: two single-tray units  
mounted on fixed shelves.

## Optimize your storage



- + This system is designed for most 36" (900 mm) corner cabinets.
- + Features a 360° rotation system.
- + The tray's central section functions as a sliding drawer bringing content to the user.
- + The drawer is equipped with full-extension slides and a dampened mechanism to ensure complete access to contents.
- + The tray's 4 1/2" (114 mm) contour height prevents contents from falling out.
- + This product is constructed from premium maple and cherry wood, finished with a catalyzed varnish for durability.
- + Each set is mounted on a ball-bearing pivot.



The single-tray version must be installed on a fixed shelf or the bottom of the cabinet. Remember to consider the space needed to accommodate the contents of the trays.

Fig.	Code	Description	Finish	Tray diameter	Min. int. height required
A	87301250	Set of 2 – 3/4 swiveling shelves and drawers	Maple	30" (762 mm)	18" (457 mm) + tray content
B	87301150	3/4 swiveling shelf and drawer	Maple	30" (762 mm)	5" (127 mm) + tray content



**A** P18R30



**B** P183R30  
The three trays swivel simultaneously



**C** P281K30



**D** P24K30, P28K30, P32K30, P1028K30 3/4 swiveling trays



*Convenient  
and economical*

Polymer swivel trays will meet all your needs. Discover Richelieu's complete range of shapes and sizes for these trays!



- + All trays are crafted from ultra-durable polymer material.
- + Trays rotate independently, except for model #P183R30, to facilitate access to stored items.
- + This product is easy to maintain.
- + Telescopic poles adjust to fit the interior height of the cabinet.
- + Heavy-duty nylon brake ensures trays remain securely in place even after movement.
- + The single-tray model includes all necessary mounting hardware and can be easily installed on a fixed shelf or on the bottom of the cabinet.

Fig.	Code	Description	Finish	Tray diameter	Int. height required
<b>Round pivoting trays</b>					
<b>A</b>	P18R30	Set of 2 round swiveling trays	White	18" (458 mm)	23" to 32" (584 to 813 mm)
<b>B</b>	P183R30	Set of 3 round swiveling trays*	White	18" (458 mm)	32" to 44" (812 to 1,118 mm)
<b>3/4 pivoting trays</b>					
<b>C</b>	P281K30	Set of 1 – 3/4 swiveling tray	White	28" (712 mm)	6" (152 mm) + tray content
<b>D</b>	P24K30	Set of 2 – 3/4 swiveling trays	White	24" (610 mm)	23" to 32" (584 to 813 mm)
<b>D</b>	P28K30	Set of 2 – 3/4 swiveling trays	White	28" (712 mm)	23" to 32" (584 to 813 mm)
<b>D</b>	P32K30	Set of 2 – 3/4 swiveling trays	White	32" (813 mm)	23" to 32" (584 to 813 mm)
<b>3/4 pivoting trays in economy packs of 10 sets</b>					
<b>D</b>	P1028K30	10 sets of 2 swiveling trays	White	28" (712 mm)	23" to 32" (584 to 813 mm)

\* All 3 trays pivot simultaneously.



*Island top made  
in mixed maple*

*Upgrade your cooking workspace with our selection of maple countertops and accessories.*

Transform your kitchen with a distinctive, natural touch by selecting maple countertops that blend elegance, durability, and functionality. Discover our accessories to enhance your cooking experience by offering a range of practical benefits, making meal preparation more user-friendly.



Island top in mixed maple



Butcher block



Built-in waste disposal



Support for bar consoles



C Steel wall-mounted application

Full-length maple countertops and island tops	116
Countertops and island tops in mixed maple	117
Butcher block and waste disposal	118
<i>Design-R</i> maple cutting boards	119
Supports for bar consoles	120
Bar consoles	121



CLEANING PREPARATION COOKING



A Full-length maple countertop

*Work surfaces for professionals!*



- + Crafted from natural North American maple, renowned for its durability and lasting quality.
- + Extensive range of dimensions available to suite various needs and preferences.
- + Staple-free assembly ensures unexpected challenges when customizing countertops to fit.
- + Features an oiled finish for reliable protection against moisture and bacterial buildup.
- + Thickness: 1 1/2" (38 mm).
- + Non-reversible design.



Dimensions sur mesure en commande spéciale.



B Full-length maple island top

Fig.	Code	Description	Wood type	Product dimensions (W x D)		
				Width	Depth	Thickness
A	2511218	Wooden countertop	Natural maple	18" (457 mm)	25" (635 mm)	1 1/2" (38 mm)
A	2511224	Wooden countertop	Natural maple	24" (610 mm)	25" (635 mm)	1 1/2" (38 mm)
A	2511230	Wooden countertop	Natural maple	30" (762 mm)	25" (635 mm)	1 1/2" (38 mm)
A	2511236	Wooden countertop	Natural maple	36" (914 mm)	25" (635 mm)	1 1/2" (38 mm)
A	2511248	Wooden countertop	Natural maple	48" (1,219 mm)	25" (635 mm)	1 1/2" (38 mm)
A	2511260	Wooden countertop	Natural maple	60" (1,524 mm)	25" (635 mm)	1 1/2" (38 mm)
A	2511272	Wooden countertop	Natural maple	72" (1,829 mm)	25" (635 mm)	1 1/2" (38 mm)
A	2511296	Wooden countertop	Natural maple	96" (2,438 mm)	25" (635 mm)	1 1/2" (38 mm)
A	2511210	Wooden countertop	Natural maple	120" (3,048 mm)	25" (635 mm)	1 1/2" (38 mm)
B	3611248	Wooden island top	Natural maple	48" (1,219 mm)	36" (914 mm)	1 1/2" (38 mm)
B	3611260	Wooden island top	Natural maple	60" (1,524 mm)	30" (762 mm)	1 1/2" (38 mm)
B	3611272	Wooden island top	Natural maple	72" (1,829 mm)	30" (762 mm)	1 1/2" (38 mm)
B	3611296	Wooden island top	Natural maple	96" (2,438 mm)	36" (914 mm)	1 1/2" (38 mm)





A Island top in mixed maple

## Maple: A trusted choice!



- + Crafted from natural North American maple, renowned for its durability and lasting quality.
- + Crafted from varying lengths and featuring mortised joints for both durability and natural look.
- + Features an oiled finish for reliable protection against moisture and bacterial buildup.
- + Integrated side grooves for easy cutting to the desired dimensions.
- + Thickness: 1 1/2" (38 mm).



A Countertop in mixed maple



B 00166 & 001668: EZ-DO gels for wood countertops for long-term sealing and protection

Before applying EZ-DO gel, the oil must be removed from the surface with denatured alcohol and then lightly sanded.



C 001212: natural water-repellent protection cream



D 001512: penetrating protective oil for wood countertops and planks



For optimal wood protection, we advise using the protective cream alongside the mineral oil regularly to prevent drying, discoloration, and cracking.

Fig.	Code	Description	Wood type	Product dimensions (W x D)		
				Width	Depth	Thickness
A	2511236150	Mixed maple countertop	Natural maple	36" (914 mm)	25" (635 mm)	1 1/2" (38 mm)
A	2511248150	Mixed maple countertop	Natural maple	48" (1,220 mm)	25" (635 mm)	1 1/2" (38 mm)
A	2511296150	Mixed maple countertop	Natural maple	96" (2,438 mm)	25" (635 mm)	1 1/2" (38 mm)
A	3011248150	Mixed maple island top	Natural maple	48" (1,220 mm)	27" (686 mm)	1 1/2" (38 mm)
A	3011260150	Mixed maple island top	Natural maple	60" (1,520 mm)	27" (686 mm)	1 1/2" (38 mm)
B	00166	EZ-DO sealing gel 16 oz (473 ml)				
B	001668	EZ-DO sealing gel 8 oz (237 ml)				
C	001212	Protective cream 5 oz (148 ml)				
D	001512	Protective oil 16 oz (148 ml)				



CLEANING PREPARATION COOKING



A

## Sturdiness and mobility

### Butcher block



- + Top-of-the-range butcher block.
- + Crafted from maple and stainless steel.
- + Meets restaurant industry standards.
- + Varnish finish.
- + Equipped with two stainless steel shelves.
- + Includes a dovetail drawer with a stainless steel front.
- + Features two 10" (254 mm) folding maple side panels.
- + Supported by stainless steel legs.
- + Fitted with 3" (76 mm) castors with brakes.

### Built-in waste disposal for all types of countertops

Prepare food, open the lid and with a simple flip of the hand, dispose of waste effortlessly into the under-counter garbage bag or compost bin.



B

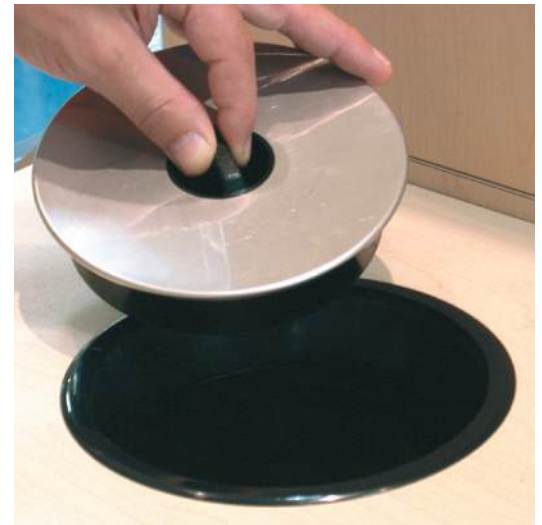

### Waste disposal

- + Fits any thickness of countertop.
- + Stainless steel lid included.
- + Clamping ring securely holds the bag beneath the countertop.



A 6 5/16" (160 mm) diameter hole must be drilled in the countertop to insert the product.

Fig.	Code	Description	Product dimensions (L x D x H)		Height	Thickness	Hole diameter
			Length	Depth			
A	5020134	Butcher block trolley	50" (1,270 mm)	20" (508 mm)	35" (889 mm)	1 3/4" (44 mm)	
B	361690170	Waste disposal for counter			5 1/4" (133 mm)		6 5/16" (160 mm)

End grain boards



A



B



C



Coat regularly with Richelieu mineral oil and conditioner to prevent drying out and discoloration.

*The most comprehensive range to meet every need*



- + Crafted from North American maple.
- + Pre-oiled boards for both durability and aesthetic appeal.
- + Available in multiple sizes and suitable for various purposes such as cutting meat, fruits, vegetables, baguettes, pizza, and more.
- + End grain construction (featured on select models) enhances durability.
- + Some models include grooves to catch juices and prevent dripping.

Striped cutting boards



D



E



F



G



H



I



J



K



L

Fig.	Code	Description	Product dimensions (L x W x H)		
			Length	Width	Height
A	115545150	End grain cutting board	16" (406 mm)	12" (305 mm)	1 1/2" (38 mm)
A	115555150	End grain cutting board	19 5/8" (498 mm)	15 3/4" (400 mm)	1 1/2" (38 mm)
B	115540150	End grain grooved cutting board	19 5/8" (498 mm)	15 3/4" (400 mm)	1 1/2" (38 mm)
C	200018150	Round butcher block	18" (457 mm)	18" (457 mm)	2" (51 mm)
D	340010150	Grooved cutting board	20" (508 mm)	16" (406 mm)	3/4" (19 mm)
D	340621150	Grooved cutting board	18" (457 mm)	12" (305 mm)	3/4" (19 mm)
E	340252150	Pastry board	22" (559 mm)	16" (406 mm)	3/4" (19 mm)
F	340305150	Fruit and vegetable cutting board	16" (406 mm)	12" (305 mm)	3/4" (19 mm)
G	340330150	French bread cutting board	24" (610 mm)	5" (127 mm)	3/4" (19 mm)
H	342003150	Paddle cutting board	20" (508 mm)	10" (254 mm)	3/4" (19 mm)
I	343812150	Meat carving cutting board	17 3/4" (451 mm)	11 3/4" (298 mm)	3/4" (19 mm)
J	384314150	Pizza board	21" (533 mm)	13" (330 mm)	3/8" (10 mm)
K	1050000	Oil and conditioner 500 ml (16,9 oz)			
L	1224000	Protective oil application kit			



CLEANING PREPARATION COOKING

## Stylish, ergonomic and durable

A bar console offers extra horizontal surface area on a countertop, island, or wall.



- + Available inclined or straight, round or square designs, in steel or aluminum – perfect for use as a countertop or an additional shelf.
- + Enhances kitchen ergonomics.
- + Crafted from durable steel or aluminum.
- + Load capacity of up to 132 lb (60 kg).
- + Compatible with both wood and glass shelves.
- + Variety of models for diverse needs and various decors.
- + To install glass shelf adapters, you will need UV glue #D030142 or #D030143 along with an ultraviolet lamp #10132490.



Application with glass shelf (A + F)

### Bar console for countertops:

The raised serving surface improves kitchen ergonomics and increases work space.



A Inclined round steel model



B Straight round steel model



C Steel wall-mounted application



D Glass shelf adapter

Fig.	Code	Description	Product dimensions		Material
			Height	Diameter	
A	24320140	Inclined round support (polished chrome)	9 1/16" (230 mm)	1 3/8" (35 mm)	Steel
A	24320170	Inclined round support (stainless steel)	9 1/16" (230 mm)	1 3/8" (35 mm)	Steel
A	24320174	Inclined round support (satin chrome)	9 1/16" (230 mm)	1 3/8" (35 mm)	Steel
A	20016170	Inclined round support (stainless steel)	4 11/32" (110 mm)	1 25/32" (45 mm)	Steel
A	20016140	Inclined round support (polished chrome)	4 11/32" (110 mm)	1 25/32" (45 mm)	Steel
A	20016174	Inclined round support (satin chrome)	4 11/32" (110 mm)	1 25/32" (45 mm)	Steel
B	20017140	Inclined round support (polished chrome)	4 11/32" (110 mm)	1 25/32" (45 mm)	Steel
B	20017170	Inclined round support (stainless steel)	4 11/32" (110 mm)	1 25/32" (45 mm)	Steel
B	20017174	Inclined round support (satin chrome)	4 11/32" (110 mm)	1 25/32" (45 mm)	Steel
C	24180170	Inclined round wall support (stainless steel)	7 7/32" (183 mm)	1 25/32" (45 mm)	Steel
C	24180174	Inclined round wall support (satin chrome)	7 7/32" (183 mm)	1 25/32" (45 mm)	Steel
D	24312140	Glass shelf adapter (polished chrome)	15/32" (12 mm)	3 17/32" (90 mm)	Steel
D	24312170	Glass shelf adapter (stainless steel)	15/32" (12 mm)	3 17/32" (90 mm)	Steel



CLEANING



PREPARATION



COOKING



E Straight square aluminum model



F Square inclined aluminum model



Fig.	Code	Description	Product dimensions		
			Height	Diameter	Material
E	2519010	Straight square support (satin aluminum)	7 15/32" (190 mm)	1 31/32" (50 mm)	Aluminum
F	2719010	Straight square support (satin aluminum)	7 15/32" (190 mm)	1 31/32" (50 mm)	Aluminum



Slide

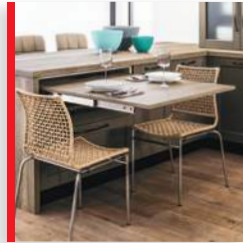

*Lunch*

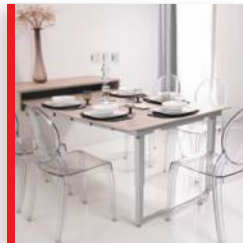

*Versoto*

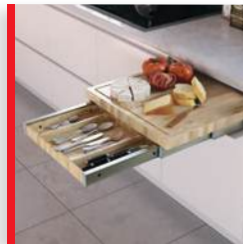

*Blade*



*Opla Top*



*Opla +39*

## *Transform space without pull-out mechanisms*

Expand the available space as the day progresses with our pull-out mechanisms. Instantly create extra workspace or storage areas. Whether in the kitchen, office, bedroom, closet, or laundry room, these systems will revolutionize your daily routine.

Pull-out table mechanisms	124
Pull-out bench and mechanisms for tables with support legs	125
<i>Blade</i> and <i>Opla-Top</i> pull-out mechanisms	126
Pull-out mechanisms for counters and shelves	127
Mechanisms for tables with support legs	128
Mechanisms for island tops	129



PREPARATION COOKING



A Cocktail



B

C

\* Please order B or C hinges separately for Cocktail models.



D Lunch



E Cheo

## A table concealed in the cabinet

Hidden within a drawer space, these revolutionary solutions are ideal for compact areas, yet they are also suitable for standard kitchens or any other room. To use the table, simply pull it out, unfold it, and then stow it away when no longer needed.



- + Pull-out table mechanism designed for seamless integration within a cabinet.
- + Replaces a standard drawer, blending into the kitchen aesthetic.
- + Includes two tabletop hinge models (excluding *Cocktail* model).
- + The table tops must be built by the customer.
- + The front bar of the mechanism can be customized to the desired width.
- + The front bar also doubles as a handle for easy table extension
- + Offers a load capacity of 132 lb (60 kg) or more, depending on the chosen model.
- + For a polished look, install a drawer front in using bottom-mounted *Euro* hinges.
- + These mechanisms not only provide additional side table functionality but also facilitate the installation of extra preparation space effortlessly. Say goodbye to cluttered counters during meal preparation.

Fig.	Code	Description	Extension	Int. width required	Int. depth required	Int. height required
A	4119312010	<i>Cocktail</i> mechanism	29 11/16" (754 mm)	16 1/8 to 46 1/8" (410 to 1,170 mm)	21 1/4" (540 mm)	4 23/32" (120 mm)
B*	411932002G	Set of 3 concealed steel hinges for <i>Cocktail</i>				
C*	411933002G	Set of 3 self-supporting steel hinges for <i>Cocktail</i>				
D	4119112010	<i>Lunch</i> mechanism	35 1/4" (895 mm)	16 1/8 to 46 1/8" (410 to 1,170 mm)	21 1/4" (540 mm)	4 23/32" (120 mm)
E	411981122	<i>Cheo</i> mechanism	42 3/8" (1,075 mm)	22 1/8 to 52 1/2" (562 to 1,332 mm)	21 5/8" (550 mm)	4 27/32" (123 mm)





**A** *T-table presented with two T-benches*

**Sturdy table and bench mechanisms offering an innovative solution for space organization.**

These models feature a telescopic folding leg, providing greater stability and load capacity. The leg conveniently folds away, allowing the entire mechanism to be neatly inserted into a drawer space.



- + Mechanisms designed to extract a table or bench from its cabinet.
- + Each model can replace a standard drawer.
- + Features sturdy, adjustable, and foldable aluminum legs.
- + Tables have a weight capacity of 220 lb (100 kg), while benches can support up to 330 lb (150 kg).
- + Includes two hinge models for table tops.
- + Customer is responsible for manufacturing the table panels and/or benches.
- + Suitable for kitchen use, these mechanisms can also be used in other areas of the house such as the laundry room or wardrobe, creating temporary workspaces to simplify your daily tasks.



Combine the *T-bench* with a *T-table* to create a temporary dining or work area. Ideal for small spaces.



**B** *T-table XL*



**C** *T-bench*

Fig.	Code	Description	Extension	Int. width required	Min. int. depth required	Min. int. height required
<b>A</b>	4119292210	<i>T-table</i> mechanism	35 1/4" (895 mm)	22 to 22 1/2" (560 to 570 mm)	21 1/4" (540 mm)	5 1/8" (130 mm)
<b>B</b>	4119192210	<i>T-table XL</i> mechanism	51 5/8" (1,310 mm)	22 to 22 1/2" (560 to 570 mm)	20 1/2" (520 mm)	5 29/32" (150 mm)
<b>C</b>	4119194510	<i>T-bench</i> mechanism	34 1/4" (870 mm)	16 1/8 to 16 1/2" (410 to 420 mm)	21 1/4" (540 mm)	5 1/8" (130 mm)



PREPARATION COOKING

TABLE MECHANISMS

PULL-OUT MECHANISMS AND COUNTER EXTENSIONS BLADE AND OPLA-TOP



Blade: complete set (A, B, C)

Blade

Reinvent drawer space with this pull-out cutting board and concealed utensil divider. The *Blade* set features a solid maple construction paired with a premium aluminum system. This innovative mechanism transforms into a dedicated workstation for meal prep, remaining hidden until needed and keeping the surface clutter-free.



- + A mechanism that expands workspace in a preparation area and uses drawer space effectively.
- + Crafted from solid maple, the cutting board and utensil divider are pre-oiled for durability and visual appeal.
- + The cutting board can be easily detached for cleaning purposes.
- + Wood is the preferred surface for cutting food as it provides natural protection against bacteria.
- + Equipped with sturdy aluminum runners with a load capacity of 132 lb (60 kg).
- + The complete set is designed for a 24" cabinet (three codes to order).
- + Customers can opt to order the mechanism separately for those who prefer to create their own board and divider.
- + Suitable for interior widths ranging from 22 1/2" (572 mm) to 34 3/4" (882 mm) with technical drawings available on [richelieu.com](http://richelieu.com).
- + The board extends by 19 11/16" (500 mm).
- + The full extension the divider reaches 32 1/4" (820 mm).



\* If you opt for a full set (including mechanism, board, and divider), the interior width should range from 22 1/2" to 22 3/4" (572 mm to 578 mm). For interior widths exceeding 22 3/4" (578 mm), customers will need to provide custom board and divider.



Closed position



A Aluminum system



B Cutting board



C Utensils divider

For a complete set, order 1 mechanism, 1 board and 1 divider

Fig.	Code	Description	Int. width required	Min. int. depth required	Min. int. height required	Finish
A	781492510	*Blade mechanism	22 1/2" to 34 3/4" (572 to 882 mm)	22 1/16" (560 mm)	4 3/4" (120 mm)	Aluminium
B	342434150	Blade cutting board	22 1/2" to 22 3/4" (572 to 578 mm)	22 1/16" (560 mm)	4 3/4" (120 mm)	Maple
C	342420150	Blade utensils divider	22 1/2" to 22 3/4" (572 to 578 mm)	22 1/16" (560 mm)	4 3/4" (120 mm)	Maple



A Opla-Top



- + Mechanism designed to expand workspace in a preparation area.
- + Concealed, it is installed in place of a drawer.
- + When activated, it extends to counter height.
- + Features aluminum runners.
- + This mechanism has a load capacity of 88 lb (40 kg).
- + Melamine components need to be built by the customer (only the mechanism is offered).

Fig.	Code	Description	Extension	Int. width required	Min. int. depth required	Min. int. height required
A	4117171010	Opla-Top mechanism	20 7/8" (530 mm)	16 1/4 to 33 7/8" (412 to 862 mm)	20 7/8" (530 mm)	4 3/4" (120 mm)



**A** *Opla +39*

**Opla +39:** Set up a temporary home office.



- + This mechanism can serve as an office surface.
- + Aluminum runners, capable of supporting up to 88 lb (40 kg).
- + Customer is responsible for manufacturing flat surface panels.
- + Installation depth reduced to 15 11/32" (390 mm).



Can be installed in a cabinet (suspended pedestal or under a counter) with reduced depth for a variety of applications.



**B** *Opla Folding*

**Opla Folding**

A concealed pull-out mechanism, installed beneath a counter or shelf, instantly expands the usable surface area. Suitable for any room in the house, simply pull the *Opla Folding* towards you and lift it up to effortlessly adjust to the height of your workspace. It offers a temporary additional surface that can easily be returned to its original position.



- + Complete mechanism provided; customers only need to manufacture the surface rings and sides to match the existing counter or shelf.
- + When extended, *Opla Folding* seamlessly adjusts to the height of the counter or shelf.
- + Includes a cushioned closing system.
- + Equipped with aluminum runners with a load capacity of 88 lb (40 kg).
- + Suitable for installation in furniture, pantry cabinets, or under counters with a minimum interior depth of 21 1/4" (540 mm).
- + The mechanism is suitable for cabinet/furniture widths ranging from 18" to 36" (450 mm to 900 mm).
- + With *Opla Folding*, the mechanism remains hidden by the side panels.



The thickness of the shelf or countertop above the product should range between 5/8" (16 mm) and 1 3/8" (35 mm).



*Opla Folding* : open position



*Opla Folding* : closed position

Fig.	Code	Description	Extension	Int. width required	Min. int. depth required	Min. int. height required
<b>A</b>	4117391010	<i>Opla +39</i> mechanism	14 5/8" (370 mm)	16 1/8" to 46 1/8" (410 to 1,170 mm)	15 3/8" (390 mm)	4 15/16" (125 mm)
<b>B</b>	4117781010	<i>Opla Folding</i> mechanism	19 11/16" (500 mm)	16 1/4" to 34 3/4" (412 to 882 mm)	21 1/4" (540 mm)	8 11/16" (220 mm)



PREPARATION COOKING

## TABLE MECHANISMS

## TABLE EXTENSION MECHANISMS WITH LEG SUPPORTS



A Party

### Family-friendly

**Party:** Robust table mechanisms offering an innovative solution for space management.

These designs feature a telescopic, folding leg, guaranteeing enhanced stability and exceptional load-bearing capacity. When not in use, the leg conveniently folds away, allowing the entire unit to be neatly stored in a drawer space.



- + Mechanism that transforms into a three-panel folding table, smoothly pulled out from your cabinet.
- + Compatible with various versions, each of which can replace a conventional drawer.
- + Features a sturdy, telescopic, folding aluminum leg.
- + This mechanism has a load capacity 220 lb (100 kg).
- + Includes two tabletop hinge models.
- + Customer is responsible for crafting the tabletop panels.

Fig.	Code	Description	Extension	Int. width required	Int. depth required	Int. height required
A	411952410	Party 24" mechanism	56 7/8" (1,446 mm)	22 1/2 to 22 3/4" (572 to 578 mm)	22" (560 mm)	5 29/32" (150 mm)
A	411953610	Party 36" mechanism	56 7/8" (1,446 mm)	34 1/2 to 34 3/4" (876 to 883 mm)	22" (560 mm)	5 29/32" (150 mm)



B Versoto

**Versoto:** The pull-out mechanism with the largest surface area.



- + Mechanism designed with anodized aluminum runners to deploy a large-format retractable table.
- + Comfortably seats four to six people.
- + Integrated telescopic leg with a load capacity of 100 kg (220 lb).
- + Customer is responsible for crafting the tabletop panels following the provided instructions.



For a modern look, *Versoto* can be installed in a wall-mounted cabinet.

Fig.	Code	Description	Extension	Int. width required	Min. int. depth required	Min. int. height required
B	4119412010	Versoto mechanism	61 1/2" (1,562 mm)	45 3/4" (1,163 mm)	20 1/8" (510 mm)	6 7/8" (175 mm)



PREPARATION COOKING

## Finally, a convivial kitchen island!

### Innovative mechanisms to optimize kitchen space.

Designed specifically for kitchen islands, these systems effortlessly provide additional space in an instant.



#### Slide

- + This mechanism makes it possible to add a sliding surface above the island.
- + Pulling the surface at 45° creates a two-sided extension of 12 1/2" (318 mm), accommodating up to four people.
- + Ideal for a dining area thanks to its diagonal movement.
- + Equipped with aluminum runners with a load capacity of 132 lb (60 kg).
- + Customer is responsible for crafting the top to match other countertops.
- + The model is equipped with a locking device when fully opened.



#### Delo

- + This mechanism creates a large sliding table that extends from the island.
- + The table seats five or six people.
- + Load capacity of 132 lb (60 kg).
- + Offers an impressive extension of 63" (1,600 mm).
- + The melamine parts must be built by the customer; only the mechanism is provided.

#### Milo

- + This mechanism creates a large sliding surface on top of an island.
- + When pulled out, the surface creates a seating area for up to four people.
- + Aluminum profile and runner system with a load capacity of 176 lb (80 kg).
- + The melamine parts must be built by the customer; only the mechanism is provided.



A Slide

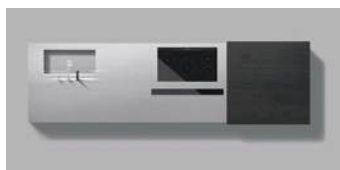

Closed mechanism

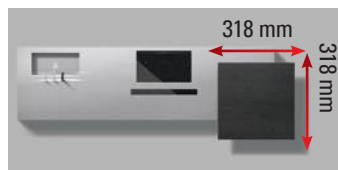

Open mechanism



\* The specified width and depth for the Slide counter mechanism correspond to the dimensions of the countertop surface.

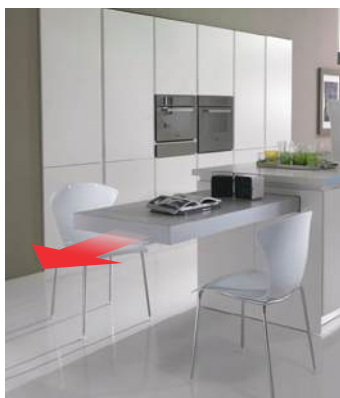

B Delo



C et D Milo



For a complete Milo system, please order the following two codes shown in the table (#4117725210 and #4117725110)

Fig.	Code	Description	Extension	Int. width required	Min. depth required	Min. height required
A	411969010	Slide mechanism	12 1/2" (318 mm)	*35 3/8 to 47 1/4" (900 to 1,200 mm)	*35 3/8 to 43 1/4" (900 to 1,100 mm)	2 3/8" (60 mm)
B	4117656010	Delo mechanism	63" (1,600 mm)	23" (584 mm)	70 1/4" (1,783 mm)	3 1/16" (78 mm)
C	4117725210	Profiles set for Milo	25 3/16" (640 mm)	96 3/4" (2,457 mm)	31 1/2" (800 mm)	3 5/32" (80 mm)
C	4117725110	Milo mechanism				



*Straightline walnut boxes with handles*



## Clever bathroom and laundry room setup

Imagine a customized storage solution designed to efficiently organize your belongings. From cosmetics to skin care, toothbrushes to towels, each item finds its rightful place.



Pull-out laundry basket



Tilting laundry basket



Pull-out storage system



Banio



Pull-out ironing board

Pull-out laundry basket	132
Tilting laundry basket and sliding storage basket	133
Banio drawer system for vanity units	134
Agon vanity drawer organizer system	136
Drawer divider and waste bin	138
Wall-mounted ironing board	139
Pull-out ironing board	140

## Mess-free solution

Explore our range of laundry basket with synchronized runners available at Richelieu.



### A and B

- + These laundry baskets feature two ventilated 35 qt (33 L) bins, one blue and the other white, facilitating sorting of laundry.
- + Each bin is equipped with ergonomic handles for effortless handling.
- + The 600 mm model (#32716030) includes a 2.64 qt (2.5 L) bin and a 12.7 qt (12 L) bin with lid, making it perfect for various uses such as detergent, fabric softener, or other items.
- + Equipped with synchronized over-extension slides:
  - Provides full access to rear bins.
  - Ensures smooth, silent movement.
  - Offers cushioned closing.
- + Load capacity of 110 lb (50 kg).
- + Product has been tested to withstand over 100,000 cycles.
- + The fixed internal metal lid maximizes storage space and helps contain odors.

### C

- + This sliding 40.2 qt (40 L) laundry basket is ideal for compact interior spaces.
- + Features full-extension runners for complete access and easy removal of bins.
- + Easy mounting with four screws at the bottom of the cabinet.



A 32714530, 2 x 35 qt (2 x 33 L)



B 32716030, 2 x 35 qt + 1 x 12.7 qt + 1 x 2.64 qt (2 x 33 L + 1 x 12 L + 1 x 2,5 L)



C 6129430, 40 L

Fig.	Code	Description	Min. int. width required	Min. int. depth required	Min. int. height required
A	32714530	Cargo 450 laundry basket	16 1/4" to 16 1/2" (412 to 418 mm)	20 3/4" (528 mm)	21 5/8" (545 mm)
B	32716030	Cargo 600 laundry basket	22 1/8" to 22 3/8" (562 to 568 mm)	20 3/4" (528 mm)	21 5/8" (545 mm)
C	6129430	Compact laundry basket	11" (280 mm)	21 1/8" (455 mm)	17 3/4" (542 mm)





**A + B**



**C + D**

Tilting laundry basket in high-quality chrome wire or white finish.



**A + B and C + D**

- + The basket is easy to remove and transport.
- + Door support must be ordered separately.
- + Door hinges and suspension arms are not included.



**A**



**B**



**C**



**D**

Remember to purchase door hinges and hanger arms. Visit [richelieu.com](http://richelieu.com) for more information.



**E** Pull-out storage system for detergents and other cleaners.



**E**

- + Features a patented opening mechanism.
- + Effortless basket removal.
- + Adjustable divider bars accommodate various container sizes.
- + Includes a removable rear tray for storing small items.
- + Simple mounting process to the bottom of the cabinet, requiring just a few screws.
- + Equipped with a front handle for convenient handling.
- + Can be installed with a door opening arm.
- + Versatile usage options include storing bottles of oil, vinegar, cleaning products, and more in the kitchen.

Fig.	Code	Description	Min. int. width required	Min. int. depth required	Min. int. height required	Finish
<b>A</b>	4056140	Tilt-Out wire hamper basket	9 5/16" (237 mm)	10 1/4" (260 mm)	16 1/2" (419 mm)	Chrome
<b>B</b>	4058140	Bracket for Tilt-Out hamper basket (A)	8 7/16" (214 mm)	5/8" (16 mm)	1" (25 mm)	Chrome
<b>C</b>	006930	Tilt-Out wire hamper basket	12 3/4" (324 mm)	14" (356 mm)	18" (457 mm)	White
<b>D</b>	406030	Bracket for Tilt-Out hamper basket (C)	8 15/16" (227 mm)	3/4" (19 mm)	1 3/16" (30 mm)	White
<b>E</b>	6150030	Pull-out storage system	14 1/4" (362 mm)	17 1/2" (445 mm)	11 5/8" (296 mm)	White

## Functional storage

The **Banio system** enhances both the functionality and aesthetic appeal of vanity drawers.

Designed specifically to accommodate return pipes, the H-profile gives a sleek and elegant look to your drawer.

Increase functionality by incorporating storage containers (sold separately).



- + Provides a simple and versatile solution for bathroom vanity units, with the flexibility to be used for under-sink drawers in the kitchen by using the extensions (sold separately).
- + Follow the provided instructions to accurately cut the bottom of your drawer.
- + Customize the *Banio* side profiles to match the interior depth of the drawer.
- + The 14.5" (370 mm) center section can also be trimmed to fit the width of your drawer.
- + Easily assemble the system by clipping the components together.
- + Optional containers can be inserted.
- + Available in finishes including white, silver grey, and dark grey.
- + Compatible with various types of drawers (melamine, wood, metal, double-walled).



Use with 16 mm (5/8") thick drawer bottoms

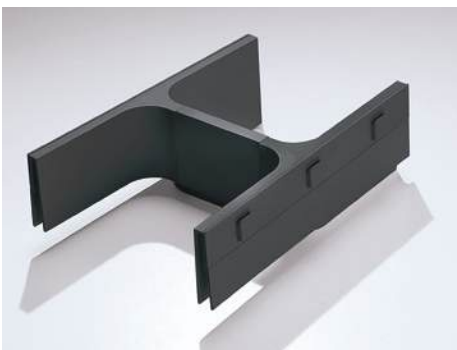

A Dark grey



A White

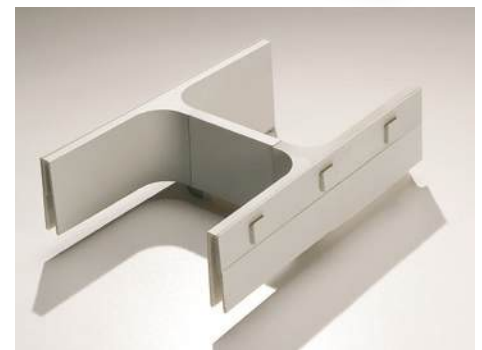

A Silver grey

Fig.	Code	Material	Min. int. dimensions required (W x D x H)			Finish
			Width	Depth	Height	
A	5031910	Plastic	4 7/8" to 18" (123 mm to 459 mm)	10 1/2" to 18 7/8" (267 to 481 mm)	2 9/16" (65 mm)	Dark grey
A	503130	Plastic	4 7/8" to 18" (123 mm to 459 mm)	10 1/2" to 18 7/8" (267 to 481 mm)	2 9/16" (65 mm)	White
A	5031100	Plastic	4 7/8" to 18" (123 mm to 459 mm)	10 1/2" to 18 7/8" (267 to 481 mm)	2 9/16" (65 mm)	Dark grey



**B**

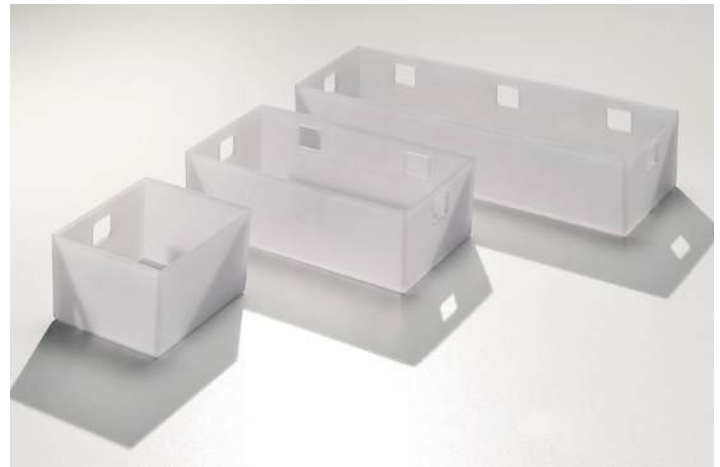

Set of three baskets for Banio dividers

**Set of 3 Banio baskets (optional)**

Fig.	Code	Material	Finish
<b>B</b>	5032905	Plastic	Graphite
<b>B</b>	503211	Plastic	Translucent



Set of three baskets includes:  
 One basket of 3 3/16" x 3 5/16" (84 mm x 84 mm)  
 One basket of 3 3/16" x 6 5/8" (84 mm x 168 mm)  
 One basket of 3 3/16" x 9 15/16" (84 mm x 252 mm)



Kitchen application of Banio set with front extension use

**Banio profile extension set**

Set of one profile and one connector, to install a wider Banio divider system for vanity cabinets or under sinks.

The set includes a 14 1/2" (370 mm) long profile that can be trimmed to the required size, along with a connector for joining two profiles to achieve the desired width.



**C** Dark grey



**C** White



**C** Silver grey

**Banio H-profile extension kit (optional)**

Fig.	Code	Material	Width*	Finish
<b>C</b>	5009910	Polymer	14 9/16" (370 mm)	Dark grey
<b>C</b>	5009030	Polymer	14 9/16" (370 mm)	White
<b>C</b>	5009100	Polymer	14 9/16" (370 mm)	Silver grey

\* Can be cut at 5/8" (16 mm) intervals.

# Agon

The three-component Agon divider system (front, left and right walls) is assembled on a drawer bottom and bypasses the waste pipe of a vanity. Optional profiles and dividers can be added to increase storage space.



- + The U-shaped design conveniently accommodates the washbasin waste pipe while maximizing storage capacity.
- + Available in a width of 13 5/64" (332 mm) with two depth options: 10 1/2" (266 mm) and 12 7/16" (316 mm).
- + Profiles and clips (available separately) allow for customizable storage configurations.
- + The system is easy to maintain.
- + This product is designed to fit 5/8" (16 mm) thick drawer bottoms and sides, making it suitable for wood or melamine drawers.



Please note that the bottom of the drawer must be cut out by the user before installation.



Silver grey



White



Dark grey

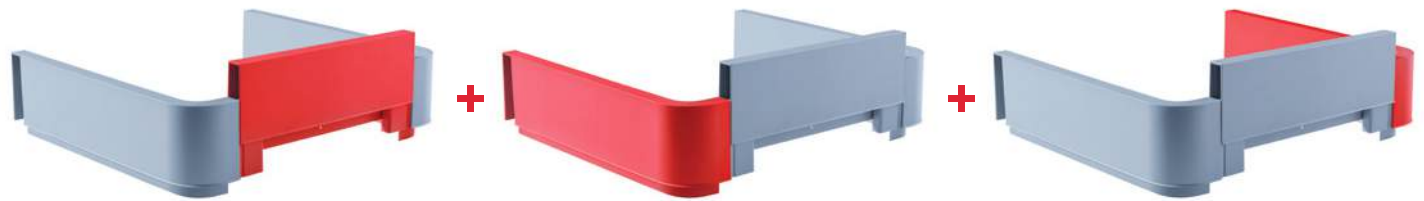

A

B

C



For a complete set, the interior installation width measures 13 5/64" (332 mm) and the depth ranges between 10 1/2" (266 mm) or 12 7/16" (316 mm), depending on the selected model.

**For a complete U-shaped set, order 1 x A, 1 x B, 1 x C**

Fig.	Description	Int. dimensions	Silver grey	White	Dark grey
A	Front wall for drawer divider 300	W: min. 13 5/64" (332 mm)	99300100	99300030	99300910
B	Vanity drawer divider 250, left	D: min. 10 1/2" (266 mm)	992503100	992503030	992503910
B	Vanity drawer divider 300, left	D: min. 12 7/16" (316 mm)	992502100	992502030	992502910
C	Vanity drawer divider 250, right	D: min. 10 1/2" (266 mm)	99303100	99303030	99303910
C	Vanity drawer divider 300, right	D: min. 12 7/16" (316 mm)	99302100	99302030	99302910



**Optional profile dividers**

- A** 70 mm (2 3/4") high and 1,000 mm (39 3/8") deep dividers (can be cut to size)
- B** Clip for U-profile or drawer side of 5/8" (16 mm).
- C** Connection clip for divider profile of 5/16" (8 mm).

**A**



Profiles can be cut to size.  
Available in silver, white or dark grey.

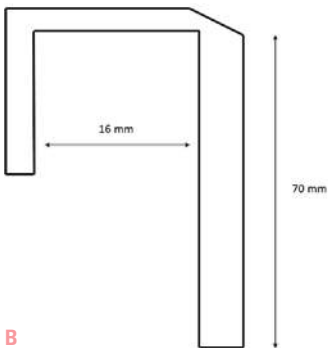

**B**

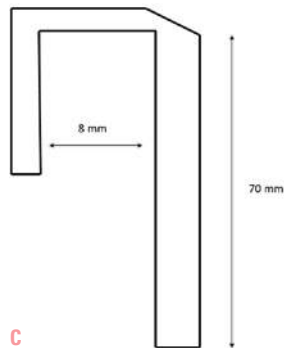

**C**



The 5/8" (16 mm) clip attaches to both the drawer sides and the side panel of the U-shaped system.

The 5/16" (8 mm) clip attaches to the profiles. (A)



**For additional storage, order a profile + the required number of clips (optional).**

Fig.	Description	Height	Silver grey	White	Dark grey
<b>A*</b>	39 3/8" (1,000 mm) profile	2 3/4" (70 mm)	99100100	99100030	99100100
<b>B</b>	5/8" (16 mm) clip	2 3/4" (70 mm)	99160100	99160030	99160910
<b>C</b>	5/16" (8 mm) clip	2 3/4" (70 mm)	99180100	99180030	99180910

\* Can be cut



A

*Look no further  
you deserve it*

#### Dividers for vanity drawers

Save time searching for makeup and hairbrushes in the bathroom. With Richelieu dividers, you can easily find everything at a glance.



#### A

- + This product is specially adapted to fit the dimensions of vanity drawers.
- + Can be cut in depth and width to match the dimensions of each drawer.
- + Suitable for use in all shallow drawers.

Fig.	Code	Material	Min. int. dimensions required (W x D x H)			Finish
			Width	Depth	Height	
A	124030	Polystyrene	11 3/4" to 13 3/4" (298 to 349 mm)	8 1/2" to 10 1/2" (216 to 267 mm)	2" (50 mm)	White
A	124530	Polystyrene	13 3/4" to 15 3/4" (349 to 400 mm)	8 1/2" to 10 1/2" (216 to 267 mm)	2" (50 mm)	White



B

#### Tilting waste bin

The tilting waste bin is designed for shallow cabinets.

It offers flexibility, being reversible for installation inside the cabinet or at the bottom of the cabinet.

Its sturdy construction ensures effortless assembly and installation, while the easily removable tray facilitates cleaning.



#### B

- + Compact size.
- + Features an 8.45 qt (8 L) bin equipped with handles.
- + Can be mounted on the side or at the back of the cabinet.
- + Opens by tilting forward, facilitating access and removal for emptying or cleaning.
- + Simple installation requiring just a few screws.
- + Integrated lid to contain odors effectively.

Fig.	Code	Material	Min. int. dimensions required (W x D x H)			Finish
			Width	Depth	Height	
B	514992030	Plastic	8 1/8" (205 mm)	9 7/16" (240 mm)	14 5/16" (364 mm)	White

## Concealed within the cupboard

Optimize space in your laundry room with these built-in ironing boards.

Choose from six models, featuring both electric and non-electric options, with pivoting or fixed designs.



- + The board is built-in, whether electric or non-electric model.
- + For electric models, the housing is included and includes light, timer, electric socket and push-button.
- + Featuring a perforated steel board for efficient ventilation.
- + Safety latch across all models.
- + With the exception of model #NE42110, all boards come with an iron storage shelf and a garment clothes rack.
- + Swivel-board models are height-adjustable.
- + All models are designed for built-in installation.
- + The housing comes in a grey wood finish with an unfinished maple veneer door.



The models shown are intended for use with a right-hand door opening configuration.



**A** Built-in electric swivel board  
AE423 door left  
AE42 door right



**B** Electric fixed built-in board  
E4213 door left  
E421 door right



**C** Economical fixed built-in board  
NE42110 Right-hand door available only



**D** Fixed non-electric built-in board  
NE42 Right-hand door available only



**E** Replacement cover

Fig.	Code	Product dimensions (W x L x H)*			Door orientation	Electric	Finish
		Width	Length of the board	Height			
A	AE423	15" (381 mm)	42" (1,070 mm)	52" (1,320 mm)	On the left	Yes	Maple veneer
A	AE42	15" (381 mm)	42" (1,070 mm)	52" (1,320 mm)	On the right	Yes	Maple veneer
B	E4213	15" (381 mm)	42" (1,070 mm)	52" (1,320 mm)	On the left	Yes	Maple veneer
B	E421	15" (381 mm)	42" (1,070 mm)	52" (1,320 mm)	On the right	Yes	Maple veneer
C	NE42110	14 1/2" (368 mm)	42" (1,070 mm)	51" (1,300 mm)	On the right	No	Maple veneer
D	NE42	15" (381 mm)	42" (1,070 mm)	52" (1,320 mm)	On the right	No	Maple veneer
E	001500						Grey

\* Consult [richelieu.com](http://richelieu.com) for installation dimensions.



A Pull-out ironing board

## Concealed within the drawer

This compact and space-saving ironing board design can be hidden away in a compartment typically reserved for a drawer. When needed, simply unfold the board for use. Once finished, fold it up and slide it back into the cabinet for storage.



- + Pull-out ironing board designed to replace a drawer.
- + Features a perforated metal board for effective ventilation.
- + The board can be adjusted to fit the interior cabinet widths ranging from 14 1/4" to 18 3/16" (362 mm to 462 mm).
- + Drawer front screws onto the frame (not included).
- + A board cover is included in the set.



Replacement cover available



B Replacement cover for 3960 model



Fig.	Code	Product dimensions (W x D x H)* Width	Depth	Height	Finish
A	3960*	14 1/4" to 19 11/16" (362 to 500 mm)	20 1/16" (510 mm)	4 1/2" to 5 3/8" (116 to 136 mm)	White metal
B	3961				Grey fabric

\* Unfolded board length: 37 3/4" (950 mm)



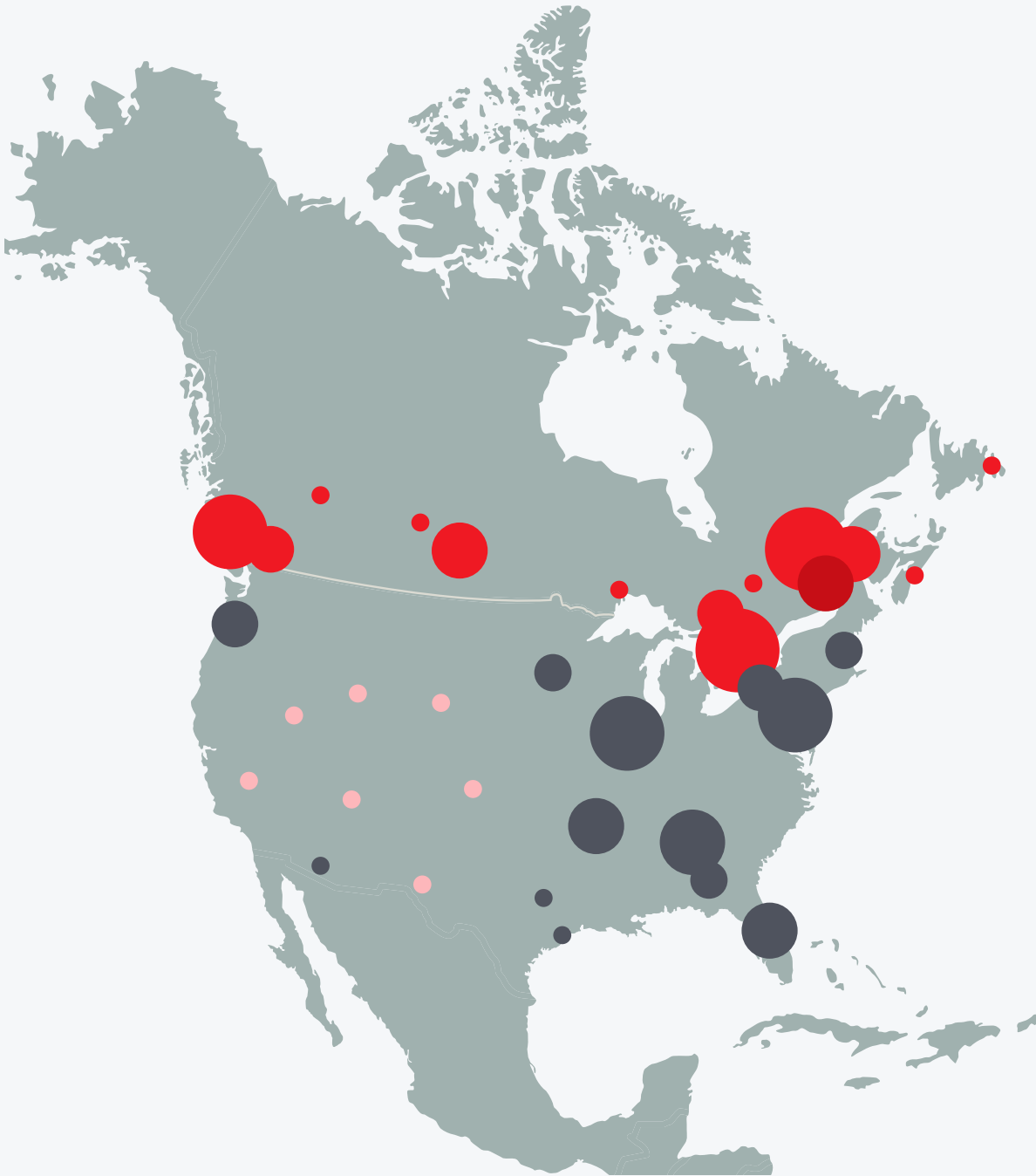

**50**  
distribution  
centres in  
Canada

**59**  
distribution  
centres in  
the United  
States

Our locations



**50 distribution centres in Canada**

- |               |               |               |
|---------------|---------------|---------------|
| Anjou         | Kitchener     | St-Jacques    |
| Barrie        | Laval (2)     | St. John's    |
| Brampton      | Longueuil (2) | Sudbury       |
| Brantford     | Mississauga   | Terrebonne    |
| Burlington    | Moncton       | Thunder Bay   |
| Calgary (4)   | MontrEal (3)  | Toronto (5)   |
| Concord       | NorthYork     | Vancouver (5) |
| Dartmouth (2) | Ottawa        | Victoria (2)  |
| Delta         | Quebec (3)    | Winnipeg      |
| Edmonton      | Regina        |               |
| Kelowna       | Saskatoon     |               |

**59 distribution centres in United States**

- |             |             |              |               |                |
|-------------|-------------|--------------|---------------|----------------|
| Atlanta (2) | Dania       | Indianapolis | Omaha         | Rochester      |
| Birmingham  | Des Moines  | Jacksonville | Orlando       | Sarasota       |
| Boston      | Detroit     | Kansas City  | Ozark         | Savannah       |
| Buffalo     | Eugene      | Lewiston     | Philadelphia  | Seattle        |
| Burlington  | Fort Myers  | Lincoln Park | Phoenix       | Sioux Falls    |
| Carlstadt   | Greensboro  | Louisville   | Pompano       | Springfield IL |
| Charlotte   | Greenville  | Memphis      | Portland ME   | St. Louis      |
| Chicago (2) | Hartford    | Minneapolis  | Portland OR   | Syracuse       |
| Cincinnati  | Hialeah     | Morristown   | Reading (2)   | Tampa Bay      |
| Columbus    | Hickory     | Nashville    | Richmond      | Thomasville    |
| Dallas      | Houston (2) | NewYork (2)  | Riviera beach |                |



Trigon I



Magic Corner II Fioro



Riverso

**CANADA**

T. 1 800 361-6000  
F. 1 800 363-0193

**USA**

T. 1 800 619-5446  
F. 1 800 876-7454

**MORE STORAGE AND  
KITCHEN SOLUTIONS**

