



FOLDAWAY AND MULTIFUNCTIONAL **BED**  
MECHANISMS



# FOLDAWAY AND MULTIFUNCTIONAL BED MECHANISMS

*"Smart Living" calls for innovative furniture that makes rooms both comfortable and versatile. Richelieu offers a wide range of ingenious bed mechanisms for opening up space and adding functionality. Our smart solutions for residential and commercial use maximize every square foot (meter) of space for a wide variety of rooms, including apartments, hotels and school dormitories.*

*Simple sliding and gliding mechanisms transform a sofa, a desk or a cabinet into a real bed for a good night's sleep. Highly functional, easy-to-use features create multipurpose living spaces that offer total comfort both day and night.*

## COMFORT • QUALITY • SAFETY • FUNCTIONALITY

INTRODUCTION .....	3
FOLDAWAY AND MULTIFUNCTIONAL BED MECHANISMS .....	4 – 12
SLIDING MECHANISM .....	13
KANGAROO BED LIFT MECHANISMS .....	14 – 15
FOLDAWAY BED MECHANISMS .....	16 – 18
BED FRAMES .....	19
CASTERS FOR UNIT PANELS .....	20

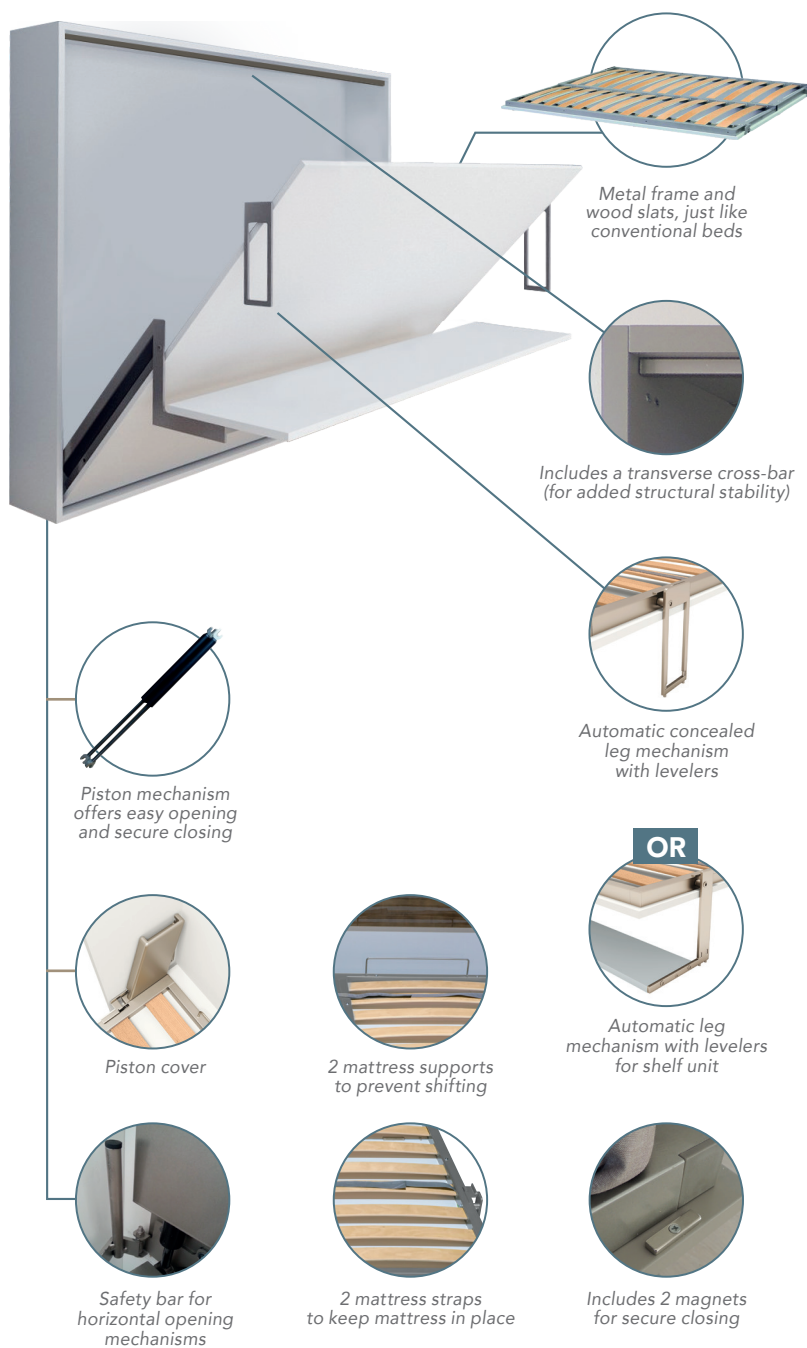

## Advantages

- Ingenious design – one room becomes many: a work living space by day and a sleeping area by night
- Fits standard North American mattress dimensions (L x W). Mattress thickness varies from 7 to 13" (178 to 330 mm)
- Piston mechanism offers easy opening and secure closing
- Maximum static load rating up to 1322 lb (600 kg)
- Legs self-deploy automatically upon opening and are concealed when closed
- For residential and commercial use
- Limited lifetime warranty on all parts
- Designed and manufactured in Italy

## How to build the cabinet

- The minimum required interior depth is based on a standard mattress thickness of 7" (180 mm). For a thicker mattress, adjust the depth of the unit.

For example, a mattress 10" thick (254 mm) requires a minimum depth of 14" (355 mm).

- Furniture panel thickness: minimum of 3/4" (19 mm)
- For more information, please visit our website at [www.richelieu.com](http://www.richelieu.com)

Mattress size	
Single bed	39" x 75" (990 x 1905 mm)
Double bed	54" x 75" (1371 x 1905 mm)
Queen bed	60" x 80" (1524 x 2032 mm)

## How to choose the right piston

### Step 1

Use this simple calculation:  
weight of the door + weight of the mattress = total weight.

### Step 2

Choose the piston with the next highest weight capacity.

# STELLA - FOLDAWAY BED/DESK MECHANISM WITH CONCEALED AUTOMATIC LEGS

## Description

The foldaway Stella bed mechanism with concealed, auto-deploying legs creates an attractive open space with two functions. In the closed position, Stella offers a work desk for daytime use, while at night, it transforms into a comfortable bed for a restful sleep.

## Advantages

- The legs and desk component are synchronized to move with the bed itself
- Single-movement opening and closing
- Static load rating: 1322 lb (600 kg)
- Matte nickel finish
- Concealed leg mechanism with adjustable levelers: +9/16" (15 mm)



### To order: choose 1 mechanism + 1 piston\*

Mattress size	Mechanism	+	Piston	Dynamic load rating
Double bed	8510014		841300H50	99 lb (45 kg)
Queen bed	8510016		84650H60	132 lb (60 kg)
			84800H70	154 lb (70 kg)
			841000H85	187 lb (85 kg)
			841300H100	220 lb (100 kg)

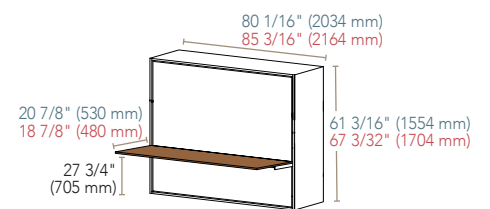
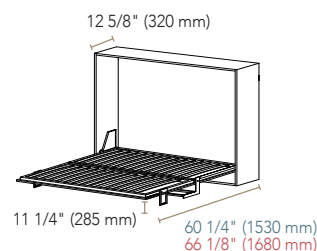

\*How to choose the correct piston: weight of the door + weight of the mattress = total weight. Choose the piston with the next highest weight capacity.

The dimensions shown in the drawings are the overall dimensions with 3/4" (19 mm) panel.

### IMPORTANT

- Maximum load for the desk component: 22 lb (10 kg)
- Anti-tip lock included
- Dimensions of the desk panel:  
Double bed: 77 9/16" x 20 7/8" x 3/4" to 1" (1970 x 530 x 19 to 25 mm)  
Queen bed: 83 1/2" x 18 7/8" x 3/4" to 1" (2120 x 480 x 19 to 25 mm)

# STELLA - FOLDAWAY BED/DESK MECHANISM WITH CONCEALED AUTOMATIC LEGS

## Description

The foldaway Stella bed mechanism with concealed, auto-deploying legs creates an attractive open space with two functions. In the closed position, Stella offers a work desk for daytime use, while at night, it transforms into a comfortable bed for a restful sleep.

## Advantages

- The legs and desk component are synchronized to move with the bed itself
- Single-movement opening and closing
- Static load rating: 1322 lb (600 kg)
- Matte nickel finish
- Concealed leg mechanism with adjustable levelers: +9/16" (15 mm)



### To order: choose 1 mechanism + 1 piston\*

Mattress size	Mechanism	Piston	Dynamic load rating
Twin bed	8521012	841100V45	88 lb (40 kg)
Double bed	8520014	841000V50	99 lb (45 kg)
Queen bed	8520016	841300V55	121 lb (55 kg)
		841500V70	143 lb (65 kg)
		841600V75	154 lb (70 kg)
		841800V85	187 lb (85 kg)
		841900V10	220 lb (100 kg)

\*How to choose the correct piston: weight of the door + weight of the mattress = total weight. Choose the piston with the next highest weight capacity.

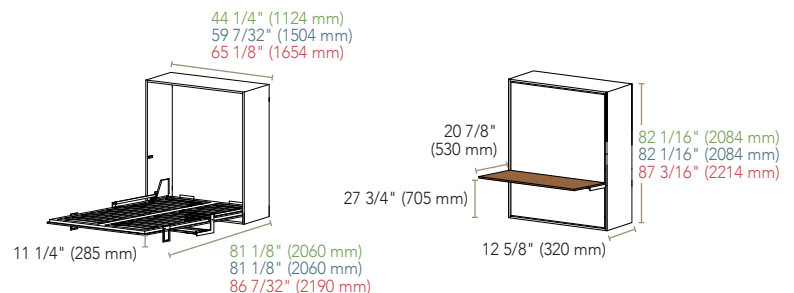

The dimensions shown in the drawings are the overall dimensions with 3/4" (19 mm) panel.

## IMPORTANT

- Maximum load for the desk component: 22 lb (10 kg)
- Anti-tip lock included
- Dimensions of the desk panel:  
Twin bed: 42 1/12" x 20 7/8 x 3/4" to 1" (1080 x 530 x 19 to 25 mm)  
Double bed: 57 31/64" x 20 7/8" x 3/4" to 1" (1460 x 530 x 19 to 25 mm)  
Queen bed: 63 25/64" x 20 7/8" x 3/4" to 1" (1610 x 530 x 19 to 25 mm)

Please refer to the installation instructions on our website for more details.

# STELLA - FOLDAWAY BED/DESK MECHANISM WITH SHELF

## Description

The foldaway Stella bed/desk mechanism with shelf creates an attractive open space with two functions. In the closed position, Stella offers both a work desk for daytime use and shelf, while at night, it transforms into a comfortable bed for a restful sleep.

## Advantages

- The shelf and desk component are synchronized to move with the bed itself
- Single-movement opening and closing
- Static load rating: 1322 lb (600 kg)
- Matte nickel finish
- Concealed leg mechanism with adjustable levelers: +9/16" (15 mm)



### To order: choose 1 mechanism + 1 piston\*

Mattress size	Mechanism	+	Piston	Dynamic load rating
Twin bed	8520012		841100V45	88 lb (40 kg)
Double bed	8521014		841000V50	99 lb (45 kg)
Queen bed	8521016		841300V55	121 lb (55 kg)
			841500V70	143 lb (65 kg)
			841600V75	154 lb (70 kg)
			841800V85	187 lb (85 kg)
			841900V10	220 lb (100 kg)

\*How to choose the correct piston: weight of the door + weight of the mattress = total weight. Choose the piston with the next highest weight capacity.

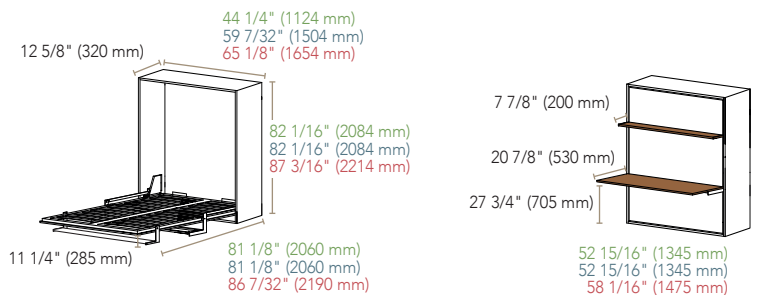

The dimensions shown in the drawings are the overall dimensions with 3/4" (19 mm) panel.

### IMPORTANT

- Maximum load for the desk component: 22 lb (10 kg)
- Maximum load for the shelf component: 11 lb (5 kg)
- Anti-tip lock included

- Dimensions of the shelf panel:
  - Twin bed: 41 7/8" x 7 7/8" x 3/4" (1064 x 200 x 19 mm)
  - Double bed: 56 27/32" x 7 7/8" x 3/4" (1444 x 200 x 19 mm)
  - Queen bed: 62 3/4" x 7 7/8" x 3/4" (1594 x 200 x 19 mm)
- Dimensions of the desk panel:
  - Twin bed: 42 1/2" x 20 7/8" x 3/4" to 1" (1080 x 530 x 19 to 25 mm)
  - Double bed: 57 31/64" x 20 7/8" x 3/4" to 1" (1460 x 530 x 19 to 25 mm)
  - Queen bed: 63 25/64" x 20 7/8" x 3/4" to 1" (1610 x 530 x 19 to 25 mm)

# CIELO - FOLDAWAY BED MECHANISM WITH CONCEALED AUTOMATIC LEGS

## Description

The foldaway Cielo bed mechanism is perfect for maximizing space. This multifunctional unit adds space by making the most of any usable area. By day, the room transforms into an open area, while by night, the unit reveals a comfortable bed.

## Advantages

- Single-movement opening and closing
- Static load rating: 1322 lb (600 kg)
- Matte nickel finish
- Concealed leg mechanism with adjustable levels: +9/16" (15 mm)

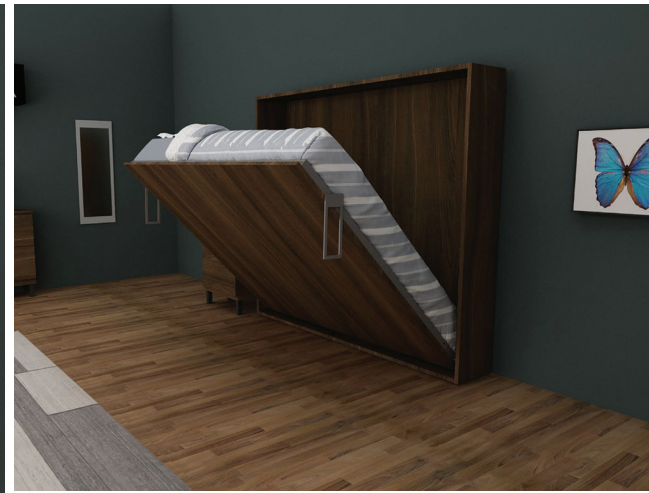

### To order: choose 1 mechanism + 1 piston\*

Mattress size	Mechanism	+	Piston	Dynamic load rating
Twin bed	8410012		841300H50	99 lb (45 kg)
Double bed	8410014		84650H60	132 lb (60 kg)
Double bed	8412014**		84800H70	154 lb (70 kg)
Queen bed	8410016		841000H85	187 lb (85 kg)
Queen bed	8412016**		841300H100	220 lb (100 kg)

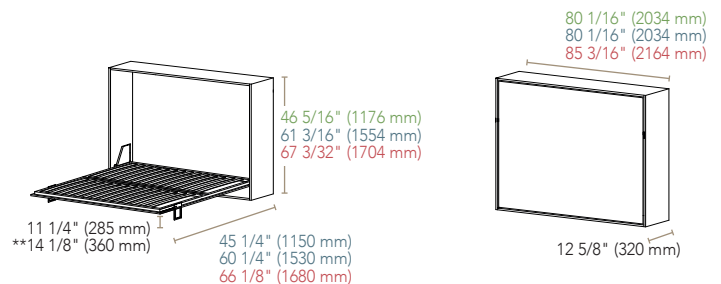

\*How to choose the correct piston: weight of the door + weight of the mattress = total weight. Choose the piston with the next highest weight capacity.

The dimensions shown in the drawings are the overall dimensions with 3/4" (19 mm) panel.

## IMPORTANT

Please refer to the installation instructions on our website for more details.

# CIELO - FOLDAWAY BED MECHANISM WITH CONCEALED AUTOMATIC LEGS

## Description

The foldaway Cielo bed mechanism is perfect for maximizing space. This multifunctional unit adds space by making the most of any usable area. By day, the room transforms into an open area, while by night, the unit reveals a comfortable bed.

## Advantages

- Single-movement opening and closing
- Static load rating: 1322 lb (600 kg)
- Matte nickel finish
- Concealed leg mechanism with adjustable levels: +9/16" (15 mm)



To order: choose 1 mechanism + 1 piston\*

Mattress size	Mechanism	+	Piston	Dynamic load rating
Simple	8420012		841100V45	88 lb (40 kg)
Double bed	8420014		841000V50	99 lb (45 kg)
Double bed	8422014**		841300V55	121 lb (55 kg)
Queen bed	8420016		841500V70	143 lb (65 kg)
Queen bed	8422016**		841600V75	154 lb (70 kg)
Queen bed half-frame	8420018		841800V85	187 lb (85 kg)
			841900V10	220 lb (100 kg)

\*How to choose the correct piston: weight of the door + weight of the mattress = total weight. Choose the piston with the next highest weight capacity.

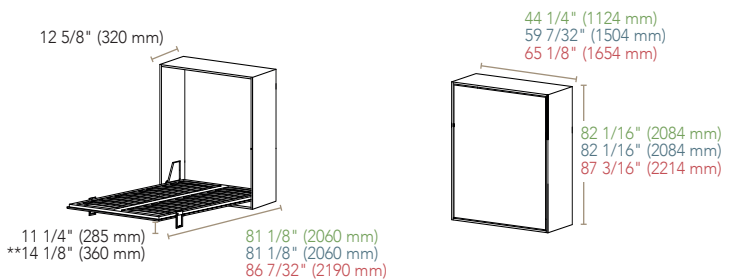

### IMPORTANT

Please refer to the installation instructions on our website for more details.



# CIELO - FOLDAWAY BED MECHANISM WITH SHELF

## Description

The foldaway Cielo bed mechanism is perfect for maximizing space. This multifunctional unit adds space by making the most of any usable area. By day, the room transforms into an open area, while by night, the unit reveals a comfortable bed.

## Advantages

- Safe, stable single shelving for books, picture frames, knick-knacks and other items
- Single-movement opening and closing
- Static load rating: 1322 lb (600 kg)
- Matte nickel finish
- Concealed leg mechanism with adjustable levelers: +9/16" (15 mm)



To order: choose 1 mechanism + 1 piston\*

Mattress size	Mechanism	+	Piston	Dynamic load rating
Twin bed	8421012		841100V45	88 lb (40 kg)
Double bed	8421014		841000V50	99 lb (45 kg)
Queen bed	8421016		841300V55	121 lb (55 kg)
Queen bed	8423016**		841500V70	143 lb (65 kg)
Queen bed half-frame	8421018		841600V75	154 lb (70 kg)
			841800V85	187 lb (85 kg)
			841900V10	220 lb (100 kg)

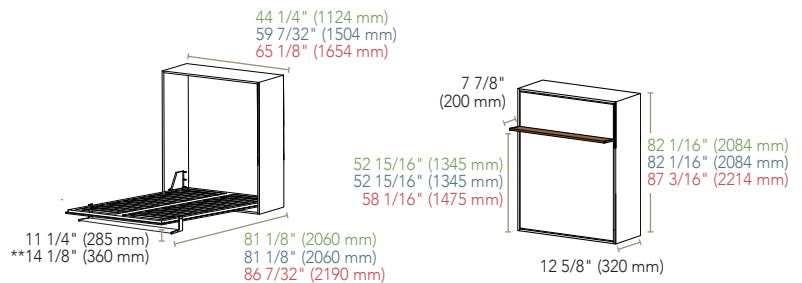

\*How to choose the correct piston: weight of the door + weight of the mattress = total weight. Choose the piston with the next highest weight capacity.

## IMPORTANT

- Maximum load for the shelf component: 11 lb (5 kg)
- Dimensions of the shelf panel:  
 Twin bed: 41 7/8" x 7 7/8" x 3/4" (1064 x 200 x 19 mm)  
 Double bed: 56 27/32" x 7 7/8" x 3/4" (1444 x 200 x 19 mm)  
 Queen bed: 62 3/4" x 7 7/8" x 3/4" (1594 x 200 x 19 mm)

Please refer to the installation instructions on our website for more details.

# CIELO - TABLA BED MECHANISM WITH CONCEALED AUTOMATIC LEGS

## Description

Eat, drink, play. It's around the dining table that much of life in the home takes place. Combine with the CIELO wall bed mechanism and you have your masterpiece!

## Advantages

- Suitable for Cielo vertical twin, double, and queen sizes
- Table top remains parallel to the floor when you pull up/down the door
- The legs and table components are synchronized to move with the bed itself
- Single-movement opening and closing
- Static load rating: 1322 lb (600 kg)
- Matte nickel finish
- Can easily seat 5 people



To order: Tabla mechanism + choose 1 mechanism + 1 piston\*

Tabla mechanism	+	Mattress size	Mechanism	+	Piston	Dynamic load rating
8425050		Twin bed	8420012		841100V45	88 lb (40 kg)
		Double bed	8420014		841000V50	99 lb (45 kg)
		Queen bed	8420016		841300V55	121 lb (55 kg)
					841500V70	143 lb (65 kg)
					841600V75	154 lb (70 kg)
					841800V85	187 lb (85 kg)
					841900V10	220 lb (100 kg)

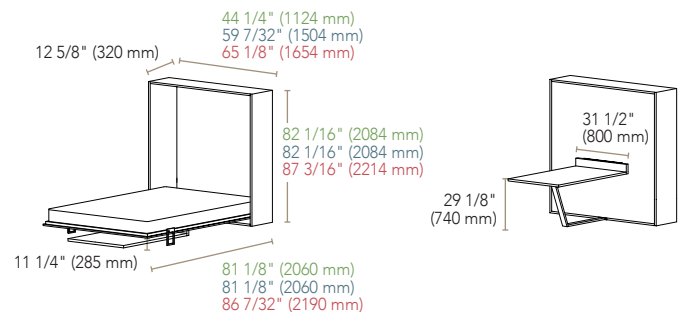

\*How to choose the correct piston: weight of the door + weight of the mattress = total weight. Choose the piston with the next highest weight capacity.

The dimensions shown in the drawings are the overall dimensions with 3/4" (19 mm) panel.

### IMPORTANT

Height between the table top and the door panel: 1 3/4" (45 mm).  
 Max. table depth: Twin & double: 45 1/2" (1155 mm)  
 Queen: 49 7/16" (1255 mm)

Table top thickness: 1" (25 mm)  
 Table foot comes with adjustable leveler: 9/16" (15 mm)

Please refer to the installation instructions on our website for more details.

# CIELO - SOFA BED MECHANISM WITH CONCEALED AUTOMATIC LEGS

## Description

The foldaway Cielo sofa bed mechanism is a multitasker: by day a comfortable sofa and by night, a cozy bed. It is equipped with a SINGLE-MOVEMENT open-and-close feature, the only one of its kind on the market!

## Advantages

- The legs and the sofa back are synchronized to move with the bed itself
- Single-movement opening and closing
- Static load rating: 1322 lb (600 kg)
- Matte nickel finish
- Concealed leg mechanism with adjustable levels: +9/16" (15 mm)



To order: choose 1 mechanism + 1 sofa mechanism + 1 piston\*

Mattress size	Mechanism	+	Sofa mechanism	+	Piston	Dynamic load rating
Double	8422014		8425180		841100V45	88 lb (40 kg)
Queen	8422016		8425170		841000V50	99 lb (45 kg)
					841300V55	121 lb (55 kg)
					841500V70	143 lb (65 kg)
					841600V75	154 lb (70 kg)
					841800V85	187 lb (85 kg)
					841900V10	220 lb (100 kg)

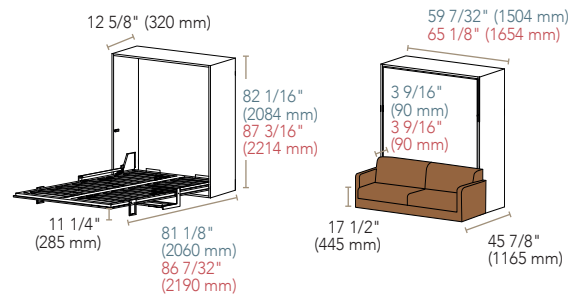

\*How to choose the correct piston: weight of the door + weight of the mattress = total weight. Choose the piston with the next highest weight capacity.

The dimensions shown in the drawings are the overall dimensions with 3/4" (19 mm) panel.

## IMPORTANT

- Sofa padding not included

Please refer to the installation instructions on our website for more details.

# TANDEM - BED/DESK MECHANISM WITH CONCEALED AUTOMATIC LEGS

## Description

Tandem is a foldaway single-bed mechanism that turns into a sleek space-saving desk that gives you more room. A perfect solution for teenagers and young adults. Also ideal for use in school residence halls, fire stations and more!

## Advantages

- The mechanism opens and closes easily, and locks when in closed position
- Static load rating: 1322 lb (600 kg)
- Single-movement opening and closing
- Matte nickel finish

Single bed with horizontal opening



### To order:

Bed size	Bed frame	+	Right mechanism	+	Left mechanism	+	Desk support mechanism	Tandem bed frame
Single bed	XULT39FBS01		XULT39FBS03		XULT39FBS04		XULT39FBS02	

Desk support mechanism



Tandem mechanism

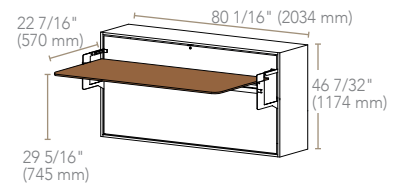
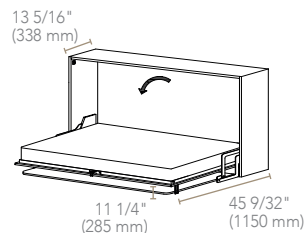
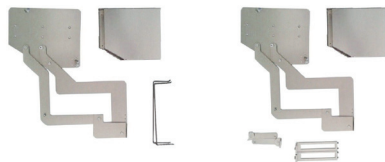

The dimensions shown in the drawings are the overall dimensions with 3/4" (19 mm) panel.

### IMPORTANT

- Mattress weight required: 44 to 55 lb (20 to 25 kg)
- Mattress thickness required: 7" (180 mm)
- Unit door weight required: 44-55 lb (20-25 kg)
- Maximum load for the desk component: 33 lb (15 kg)

# SLIDING MECHANISM FOR BEDS AND DESKS

## Description

Here's an ingenious solution for storing furniture and opening up more space with minimum effort. This sliding mechanism lets you quickly move several pieces of furniture one under the other to create more open space!

## Advantages

- An ideal solution for rooms that are used both for daytime activities and sleeping
- Store several pieces of furniture in the space normally occupied by just one
- Easier and faster way to move beds and desks along the wall
- Stoppers allow you to move the furniture safely

**Clear space instantly**



### To order:

Aluminum wall rail	+	Sliding mechanism
841050673		841000100

Aluminum wall rail  
Length: 118 1/8" (3000 mm)  
Width: 13/16" (21 mm)  
Height: 1 9/16" (40 mm)



### Includes:

- 1 right support plate with brake
- 1 left support plate
- 2 stoppers
- 2 end caps
- 2 screws

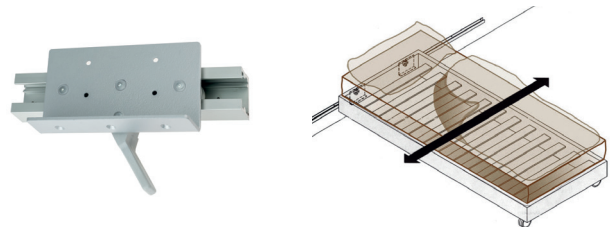

### Better rails

- Can be easily cut to measure
- Combine with other rails to increase length
- Quality materials for fluid sliding movement
- Supports up to two pieces of furniture (1 bed + 1 desk, 2 beds or 2 desks)

### IMPORTANT

- One furniture unit per sliding mechanism
- Up to 2 sliding mechanisms can be installed per rail
- Multiple configurations through use of different rails and mechanisms
- Requires panel caster (see page 20)

Please refer to the installation instructions on our website for more details.

# KANGAROO LIFT MECHANISM AND BED FRAME

## Description

Richelieu offers a wide range of convenient mechanisms for creating under-bed storage that is easy and safe to access.

## Advantages

- Creates an extra storage area
- Easy to install
- Simple to open and close
- Extends the life of your mattress
- Static load rating: 772 lb (350 kg)



### To order:

Bed size	Metal bed frame with wood slats (1)	Metal bed frame with plywood sheet (2)
Single bed	<b>XULT39</b>	-
Double bed	<b>XULT54</b>	-
Queen bed	<b>XULT60</b>	<b>XULT60P</b>
King bed	<b>XULT80</b>	<b>XULT80P</b>



Kangaroo mechanism	Maximum dynamic load rating
<b>XKANG39</b>	88 lb (40 kg)
<b>XKANG54S</b>	110 lb (50 kg)
<b>XKANG60S</b>	198 lb (90 kg)
<b>XKANG80S</b>	242 lb (110 kg)
<b>XKANG140</b>	308 lb (140 kg)

### Optional:

Complementary products	Description	Dimensions: Width x Length
<b>481754130</b>	Corner bracket	7 1/16" x 9 1/16" (180 x 230 mm)
<b>8400190</b>	Fiber handle	1 1/2" x 15 1/8" (38 x 385 mm)



Bed frames

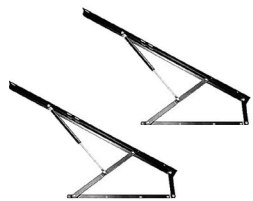

Piston

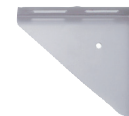

Corner bracket



Fiber handle

### IMPORTANT

How to choose the Kangaroo mechanism

Step 1: weight of the bed frame + weight of your mattress = total weight.

Step 2: choose the piston with the next highest weight capacity.

Please refer to the installation instructions on our website for more details.

# DOUBLE PISTON LIFT MECHANISM AND PREMIUM QUALITY BED FRAME

## Description

This innovative system utilizes an ingenious mechanism with double pistons for creating under-bed storage that is easy and safe to access.

## Advantages

- Stabilizing bar provides optimal stability
- Mattress support prevents tipping
- Automatic locking system
- Maximal static load rating for bed frames: 992 lb (450 kg)



### To order:

Bed size	Metal bed frame with wood slats	+	Mechanism	Maximum dynamic load rating
Single bed	<b>XULT39BMU</b>	→	<b>XULT39LM</b>	88 lb (40 kg)
Double bed	<b>XULT54BMU</b>	→	<b>XULT54LM</b>	110 lb (50 kg)
Queen bed	<b>XULT60BMU</b>	→	<b>XULT60LM</b>	143 lb (65 kg)
King bed	<b>XULT80BMU</b>	→	<b>XULT80LM</b>	165 lb (75 kg)

Complementary products	Description	Dimensions: Width x Length
<b>C240BMU</b>	Set of 4 corners	9 7/16" x 4" (240 x 100 mm)

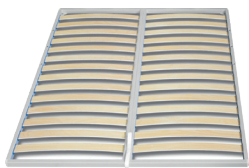

Metal bed frame with wood slats

+



Double piston lift mechanism

+



Corners

### IMPORTANT

Please refer to the installation instructions on our website for more details.

# VERTICAL WALL BED MECHANISM WITH PISTONS AND AUTOMATIC LEGS

## Description

Open your foldaway bed effortlessly every day thanks to this proven mechanism and its clever system of automatic legs.

## Advantages

- Locking system engages in the open position
- Mattress straps and supports prevent tipping or movement
- Static load rating: 1322 lb (600 kg)
- Metal bed frame with attachment for unit door

Effortless  
everyday  
use



The system includes a full metal frame with wood slats



Locking system engages in the open position



Automatic legs

## To order:

No.	Description	Maximum dynamic load rating	FRAME BED DIMENSIONS		INTERIOR DIMENSIONS REQUIRED	
			Width	Length	Width	Height
XULT39WBVT	Single bed	154 lb (70 kg)	40 3/16" (1020 mm)	76" (1930 mm)	42 3/4" (1086 mm)	82 1/8" (2085 mm)
XULT54WBVT	Double bed	309 lb (140 kg)	55 1/8" (1400 mm)	76" (1930 mm)	57 3/4" (1466 mm)	82 1/8" (2085 mm)
XULT60WBVT	Queen bed	309 lb (140 kg)	61" (1550 mm)	81" (2060 mm)	63 5/8" (1616 mm)	87 3/16" (2215 mm)

## IMPORTANT

- Horizontal model for double and Queen size beds available by special order
- When mounting the unit, use 3/4" (19 mm) front panels and 1" (25 mm) side panels
- Minimum interior depth: 16 1/8" (410 mm)

Please refer to the installation instructions on our website for more details.



# SINGLE HORIZONTAL WALL BED MECHANISM

## Description

Whether you need an extra bed in your own home or for a business, this perfect space-saving solution is a quick way to install a foldaway bed or two bunkbeds that are both comfortable and safe to use. Also ideal for hotels and barracks!

## Advantages

- The single-bed model can be installed high or low on the wall or as bunkbeds
- Mattress supports prevent any unwanted movement
- Includes a locking mechanism when open for enhanced safety and easier operation
- Static load rating: 1322 lb (600 kg)

**1 bed or  
2 bunkbeds**



HORIZONTAL WALL BED MECHANISM  
(upper bunk) **XULT36WBHX**

### The set includes:

- A metallic bed frame with wooden slats
- A spring-based mechanism with an integrated locking system



Requires a minimum interior height of: 85 7/8" (2180 mm)

**With a manual foldaway ladder**

HORIZONTAL WALL BED MECHANISM (lower bunk)  
**XULT36WBHZ**

### The set includes:

- A metallic bed frame with wooden slats
- A spring-based mechanism with an integrated locking system



**With automatic legs**

## To order:

No.	Description	Maximum dynamic load rating	FRAME BED DIMENSIONS		INTERIOR DIMENSIONS REQUIRED		
			Width	Length	Width	Height	Minimum depth
<b>XULT36WBHX</b>	Upper bunk	154 lb (70 kg)	37" (940 mm)	76" (1930 mm)	78 5/8" (1996 mm)	41 11/32" (1050 mm)	15 3/4" (400 mm)
<b>XULT36WBHZ</b>	Lower bunk	154 lb (70 kg)	37" (940 mm)	76" (1930 mm)	78 5/8" (1996 mm)	41 11/32" (1050 mm)	15 3/4" (400 mm)

## IMPORTANT

When mounting the unit, use 3/4" (19 mm) front panels and 1" (25 mm) side panels

Please refer to the installation instructions on our website for more details.

# VERTICAL FOLDAWAY BED MECHANISM

## Description

This mechanism gives you an easy, quick way for mounting a bed into a furniture unit.

## Advantages

- Bolt on the back of mechanism makes it easy to regulate spring tension
- Spring mechanism lifetime approved for 20,000 opening and closing cycles of the bed

**Sturdy and comfortable**



Spring tension adjustment

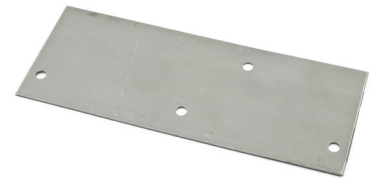
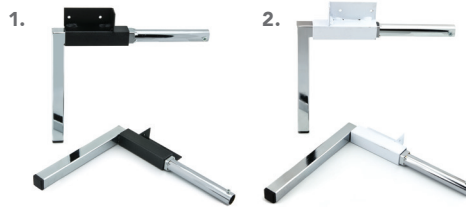

### To order:

Bed size	Mechanism	Finish	MAXIMUM LOAD RATING	
			Static	Dynamic
Single bed	108130	White	375 lb (170 kg)	154 lb (70 kg)
	108190	Black		
Double bed	108230	White	661 lb (300 kg)	220 lb (100 kg)
	108290	Black		
Queen bed	108430	White	661 lb (300 kg)	309 lb (140 kg)
	108490	Black		

+

	Manually deployed legs	Finish	Height
1	40890	Nickel/black	7 7/8" (200 mm)
	41090		9 27/32" (250 mm)
2	4082G	Zinc/white	7 7/8" (200 mm)
	4002G		9 27/32" (250 mm)
	4132G		13 3/8" (340 mm)

### Optional:

Complementary product	Description
10810812	Reinforced plate for 5/8" (16 mm) & 3/4" (19 mm) side panels

### IMPORTANT

Please refer to the installation instructions on our website for more details.

# BED FRAMES

Sturdy and ergonomic

This range of bed frames offers custom-sized bed bases



- A** Metal bed frame with a silver finish and Italian slats\*
- Designer: Gianfranco Pessotto
  - Engineered in Europe, this metal bed frame offers both superior strength and ergonomic slats for exceptional comfort
  - Static load rating: 992 lb (450 kg)



- B** Metal bed frame with a black finish and standard slats in shaped poplar plywood\*\*
- Static load rating: 772 lb (350 kg)

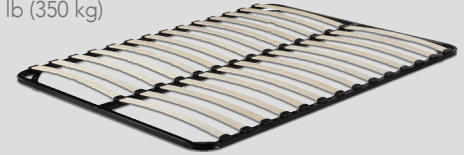

- C** This folding metal bed frame is similar to B, providing access to the under-bed storage space\*\*
- Static load rating: 772 lb (350 kg)

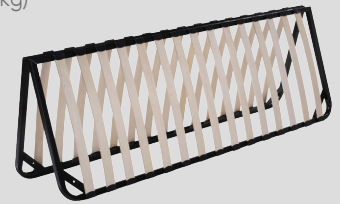

- D** Metal bed frame with plywood slats of 1/2" (12 mm)
- Static load rating: 882 lb (400 kg)



**To order:**

	No.	Description	Width x Length	Slats
<b>A</b>	<b>XULT39BMU</b>	Single bed	38 25/32" x 74 13/16" (985 x 1900 mm)	1 x 13 = 13 slats
	<b>XULT54BMU</b>	Double bed	53 9/16" x 74 13/16" (1360 x 1900 mm)	2 x 13 = 26 slats
	<b>XULT60BMU</b>	Queen bed	59 7/16" x 79 1/8" (1510 x 2010 mm)	2 x 14 = 28 slats
	<b>XULT80BMU</b>	King bed	77 3/16" x 79 1/8" (1960 x 2010 mm)	2 x 14 = 28 slats
<b>B</b>	<b>XULT39</b>	Single bed	38 1/2" x 74 1/2" (978 x 1892mm)	1 x 18 = 18 slats
	<b>XULT54</b>	Double bed	53 1/2" x 74 1/2" (1359 x 1892mm)	2 x 18 = 36 slats
	<b>XULT60</b>	Queen bed	59 1/2" x 79 1/2" (1511 x 2019 mm)	2 x 20 = 40 slats
	<b>XULT80</b>	King bed	(2x) 38 1/2" x 79 1/2" (978 x 2019 mm)	2 x 20 = 40 slats
<b>C</b>	<b>XULT80FOLD</b>	King bed	77 15/16" x 79 1/2" (1980 x 2019mm)	3 x 20 = 60 slats
	<b>XULT81FOLD</b>	King bed	76" x 79 1/2" (1930 x 2019 mm)	2 x 20 = 40 slats
<b>D</b>	<b>XULT60P</b>	Queen bed	59 1/2" x 79 1/2" (1511 x 2019 mm)	-
	<b>XULT80P</b>	King bed	(2 x) 38 1/2" x 79 1/2" (978 x 2019 mm)	-

**IMPORTANT**

\*Frame dimensions: 1 1/4" x 1 1/2" (30 x 40 mm) / Wood slat dimensions: 2 5/8" x 3/8" (70 x 10 mm)

\*\*Frame dimensions: 1 1/4" x 1 1/4" (30 x 30 mm) / Wood slat dimensions: 2" x 3/8" (50 x 10 mm)

Please refer to the installation instructions on our website for more details.

# CASTERS FOR UNIT PANELS

## Advantages

- Single direction design for use with dressers, small beds and other furniture
- Suitable for all indoor surfaces
- Gray finish
- Ideal for the sliding bed mechanism, see page 13

**Subtle styling**



80964022100

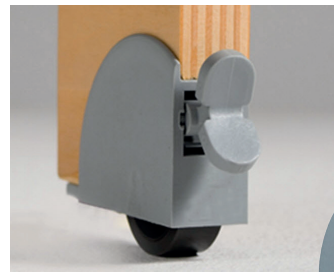

80954018100

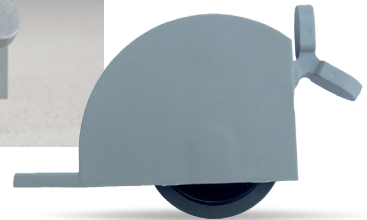

**To order:**

No.	Description	Panel depth	Dynamic load rating / caster
80964022100	Fixed	Min. 7/8" (22 mm)	132 lb (60 kg)
80954018100	With brake	Min. 3/4" (19 mm)	110 lb (50 kg)
809405010	With brake	Min. 1 3/16" (30 mm)	Max. 176 lb (80 kg)



809405010





Serving you across North America

**CANADA**  
Tel.: 1 800 361-6000  
Fax: 1 800 363-0193

**UNITED STATES**  
Tel.: 1 800 619-5446  
Fax: 1 800 876-7454



BED16E 01-2022  
Printed in Canada \$2