

ÉDITION DESIGNER

POUR MEUBLE

PATTES & ROULETTES



Richelieu

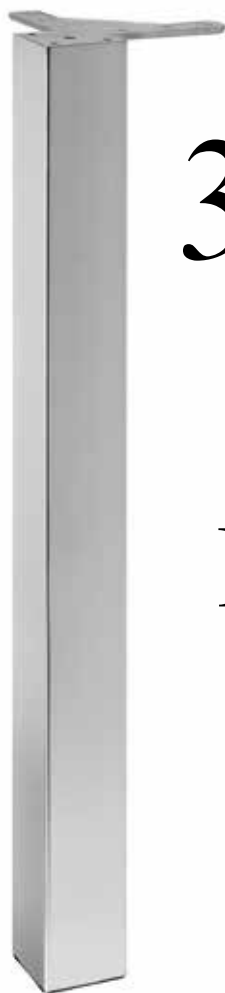

3. roulettes de meuble

4 Comment choisir une roulette

5-7 Roulettes design

8-9 Roulettes vintage

10-12 Roulettes contemporaines

13 Roulettes pour panneaux

14. pattes de meuble

15 Comment choisir une patte de meuble

16 Pattes design

17-21 Pattes contemporaines

22-23 Pattes vintage

24-25 Autres pattes de meuble

26-27 Pattes pour lit et sofa

28-29 Pattes en ABS

30. pattes de table

31 Comment choisir une patte de table

32-33 Pattes de table design

34-36 Pattes de table contemporaines

37 Pattes de table vintage

38-39 Pattes de table polyvalentes





AJOUTEZ
UNE TOUCHE
D'ORIGINALITÉ
À VOS MEUBLES
AVEC CES
ROULETTES
NOVATRICES

roulettes



COMMENT CHOISIR UNE roulette de meuble

À chaque application ses roulettes. Consultez notre guide pour bien choisir les vôtres. Les pictogrammes présentés dans cette page vous aideront à comprendre les caractéristiques techniques des produits.



FINI

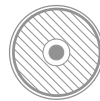

Richelieu propose une multitude de styles et de couleurs de roulettes pour tous les types d'applications. Ce symbole vous indiquera le fini de la roulette.

DIAMÈTRE



En plus de l'aspect de la roulette, il faut tenir compte du diamètre pour optimiser la mobilité du meuble. Plus le diamètre est élevé, plus le meuble est facile à déplacer.

HAUTEUR



Les hauteurs indiquées dans ce catalogue correspondent à la hauteur totale de la roulette.

LARGEUR



Ce symbole correspond à la largeur totale de la roulette.

FREIN



Selon l'usage du meuble, il peut être judicieux d'opter pour des roulettes à frein. Elles offrent plus de stabilité et sont plus sûres, surtout sur les sols en pente.

TIGE

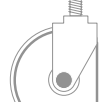

FIXATION À TIGE

Tige à insérer et à visser dans le meuble. Ceci implique la mise en place d'une douille dans laquelle la tige sera vissée.

PLAQUE

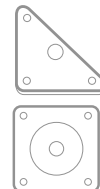

FIXATION À PLAQUE

Plaque à visser sur le fond du meuble.

CAPACITÉ DE CHARGE DYNAMIQUE / ROULETTE



La capacité de la roulette est déterminée non seulement par le poids du meuble, mais aussi par la charge que le meuble supportera.

PROTECTION DU SOL



Si le meuble est destiné à être utilisé sur un plancher de bois ou de céramique, optez pour des roulettes qui ne marquent pas le sol.

ROULETTES DESIGN

L'harmonie parfaite entre design et fonctionnalité.



sophistiquée

#	No.								
1.	812848140	Transparent	3 5/32" (80 mm)	4 7/8" (124 mm)	2" (50 mm)			1 29/32" x 1 29/32" (48 x 48 mm)	Max. 110 lb (50 kg)
2.	11801140100	Gris, chrome	3 5/32" (80 mm)	4 23/32" (120 mm)	27/32" (22 mm)		15/32" x 25/32" (12 x 20 mm)	1 27/32" x 1 27/32" (47 x 47 mm)	Max. 55 lb (25 kg)
	11801185100	Nickel satiné, gris							
	11804140100	Gris, chrome							
3.	1280114090	Noir, chrome	3 5/32" (80 mm)	4 1/2" (114 mm)	1" (25 mm)		15/32" x 25/32" (12 x 20 mm)	1 27/32" x 1 27/32" (47 x 47 mm)	Max. 55 lb (25 kg)
	1280118590	Nickel satiné, noir							
	1280414090	Noir, chrome							
	1280418590	Nickel satiné, noir							
4.	232100106	Argent	3 5/32" (80 mm)	4 11/32" (110 mm)	1 5/32" (29 mm)		M8 x 15 mm		Max. 33 lb (15 kg)
5.	8088128015	Noir, rouge	3 17/32" (90 mm)	4 23/32" (120 mm)	1 9/32" (32 mm)			1 27/32" x 1 27/32" (47 x 47 mm)	Max. 132 lb (60 kg)
	8088128010	Aluminium, noir							
	8088128140	Noir, chrome							

Tous ces modèles ne laissent aucune trace au sol.

ROULETTES DESIGN



#	No.									
1.	5076114080	A	Rouge, chrome	1 31/32" (50 mm)	3 17/32" (90 mm)	2 31/32" (76 mm)	✓	1 27/32" x 1 27/32" (47 x 47 mm)	Max. 176 lb (80 kg)	
	5076130101	B	Gris, blanc				✓			
	50761140101	C	Gris, chrome				✓			
	507613090	D	Noir, blanc				✓			
	5076114090	E	Noir, chrome				✓			
	507613080	F	Rouge, blanc				✓			
2.	307141100	A	Gris métallisé, gris mat	2 11/16" (68 mm)	2 7/8" (73 mm)	1 25/32" (45 mm)	✓	1 27/32" x 1 27/32" (47 x 47 mm)	Max. 110 lb (50 kg)	
	307145100						Autobloquante			7/16" x 25/32" (11 x 20 mm)
	307147100						Autobloquante			7/16" x 25/32" (11 x 20 mm)
	307151140	B	Noir, chrome				1 27/32" x 1 27/32" (47 x 47 mm)			
307157140	Autobloquante			7/16" x 25/32" (11 x 20 mm)						
3.	815100110	Aluminium		3 15/16" (100 mm)	4 23/32" (120 mm)	3 1/4" (82 mm)	✓	3 3/16" x 3 3/16" (81 x 81 mm)	Max. 176 lb (80 kg)	
	815100210						✓			
4.	97510022502	Noir, chrome		2 15/16" (75 mm)	4 1/32" (102 mm)	1 9/16" (40 mm)	✓	1 31/32" x 1 31/32" (50 x 50 mm)	Max. 110 lb (50 kg)	
	815210813	Vert		1 9/16" (40 mm)	1 25/32" (45 mm)	2 23/32" (68 mm)		M8 x 15 mm	Max. 77 lb (35 kg)	
5.	815210611	Gris clair					✓			
	815110611									

Tous ces modèles ne laissent aucune trace au sol.

fonctionnalité





1



Frein

UNE TOUCHE
D'ORIGINALITÉ
POUR UN STYLE
RUSTIQUE
INIMITABLE

design



ROULETTES VINTAGE

Un nouveau regard sur le style traditionnel.



#	No.																
1.	8750201AB90	Laiton rustique	2 15/16" (75 mm)	3 27/32" (98 mm)	1 25/32" (45 mm)	✓	2 11/32" x 2 11/32" (60 x 60 mm)	Max. 110 lb (50 kg)									
	8750202AB90		3 15/16" (100 mm)	4 29/32" (125 mm)						✓	Max. 132 lb (60 kg)						
	81000201AB90											4 29/32" (125 mm)	5 15/16" (151 mm)	✓	Max. 176 lb (80 kg)		
	81250201AB90															3 5/8" x 2 17/32" (92 x 64 mm)	Max. 176 lb (80 kg)
	81250202AB90																
2.	875020190290	Acier rustique	2 15/16" (75 mm)	3 27/32" (98 mm)	1 25/32" (45 mm)	✓	2 11/32" x 2 11/32" (60 x 60 mm)	Max. 110 lb (50 kg)									
	875020290290		3 15/16" (100 mm)	4 29/32" (125 mm)						✓	Max. 132 lb (60 kg)						
	8100020190290											4 29/32" (125 mm)	5 15/16" (151 mm)	✓	Max. 176 lb (80 kg)		
	8125020190290															3 5/8" x 2 17/32" (92 x 64 mm)	Max. 176 lb (80 kg)
	8125020190290																
3.	875020114090	Noir, chrome	2 15/16" (75 mm)	3 27/32" (98 mm)	1 25/32" (45 mm)	✓	2 11/32" x 2 11/32" (60 x 60 mm)	Max. 110 lb (50 kg)									
	875020214090		3 15/16" (100 mm)	4 29/32" (125 mm)						✓	Max. 132 lb (60 kg)						
	8100020214090																
	8100020114090																
4.	87502019090	Noir	2 15/16" (75 mm)	3 27/32" (98 mm)	1 25/32" (45 mm)	✓	2 11/32" x 2 11/32" (60 x 60 mm)	Max. 110 lb (50 kg)									
	87502029090		3 15/16" (100 mm)	4 29/32" (125 mm)						✓	Max. 132 lb (60 kg)						
	810002029090																
	810002019090																
5.	87502010502	Aluminium	2 15/16" (75 mm)	3 27/32" (98 mm)	1 25/32" (45 mm)	✓	2 11/32" x 2 11/32" (60 x 60 mm)	Max. 110 lb (50 kg)									
	87502020502																

Tous ces modèles ne laissent aucune trace au sol.

moderne

1



Frein



Transparent



Fumé

2



3



Frein

4



5



Tige filetée



Frein

6



Frein

7



ROULETTES CONTEMPORAINES

Un minimalisme intemporel pour des meubles tendance.



8



élégante

#	No.								
1.	6412501011	Transparent	1 31/32" (50 mm)	2 17/32" (64 mm)	1 1/2" (38 mm)	✓	1 31/32" x 1 31/32" (50 x 50 mm)	Max. 66 lb (30 kg)	
	64125010217	Fumé							
	6412501111	Transparent							
	64125011217	Fumé	2 15/16" (75 mm)	3 19/32" (91 mm)		✓	1 31/32" x 1 31/32" (50 x 50 mm)	Max. 88 lb (40 kg)	
	6412751011	Transparent							
	64127510217	Fumé							
	6412751111	Transparent							
64127511217	Fumé	✓							
2.	47503010605	Blanc transparent	2 15/16" (75 mm)	3 27/32" (98 mm)	31/32" (25 mm)	✓	2 1/32" x 3 5/32" (52 x 80 mm)	Max. 110 lb (50 kg)	
	410003010605	Blanc transparent	3 15/16" (100 mm)	4 29/32" (125 mm)	✓	Max. 132 lb (60 kg)			
3.	210003010607	Bleu royal, transparent	3 15/16" (100 mm)	4 29/32" (125 mm)	15/16" (24 mm)	✓	2 1/32" x 3 5/32" (52 x 80 mm)	Max. 132 lb (60 kg)	
	210003020607	Bleu royal, transparent							
4.	26502010502	Gris, transparent	2 17/32" (64 mm)	3 11/32" (85 mm)	15/16" (24 mm)	✓	2 11/32" x 2 11/32" (60 x 60 mm)	Max. 88 lb (40 kg)	
	26502020502	Gris, transparent							
5.	26502020513	Gris clair	2 17/32" (64 mm)	3 3/8" (86 mm)	15/16" (24 mm)	✓	M10 x 15 mm	Max. 88 lb (40 kg)	
	27583010502	Gris clair	2 15/16" (75 mm)	3 27/32" (98 mm)	15/16" (24 mm)	✓		Max. 99 lb (45 kg)	
	27583020502	Gris clair							
6.	75002010501	Gris, chrome satiné	1 31/32" (50 mm)	2 3/4" (70 mm)	2 3/16" (55 mm)	✓	1 21/32" x 1 21/32" (42 x 42 mm)	Max. 66 lb (30 kg)	
	75002020501	Gris, chrome satiné							
7.	85024011201	Aluminium, noir	1 31/32" (50 mm)	2 9/16" (65 mm)	25/32" (20 mm)		1 21/32" x 1 21/32" (42 x 42 mm)	Max. 88 lb (40 kg)	
8.	35010010501	Transparent	1 31/32" (50 mm)	2 9/16" (65 mm)	25/32" (20 mm)	✓	1 21/32" x 1 21/32" (42 x 42 mm)	Max. 88 lb (40 kg)	
	35010050201			2 9/16" (65 mm)	25/32" (20 mm)				
	35056010501			2 1/4" (57 mm)	25/32" (20 mm)				

Tous ces modèles ne laissent aucune trace au sol.

ROULETTES DOUBLES CONTEMPORAINES



#	No.								
1.A*	40190	Noir	1 9/16" (40 mm)	1 7/8" (48 mm)	1/2" (38 mm)	✓	5/16" X 1 1/2" (8 X 38 mm)	Max. 55 lb (25 kg)	
	4341190		1 31/32" (50 mm)	2 9/32" (58 mm)	1 3/4" (44 mm)	✓			
	50190		1 9/16" (40 mm)	3 17/32" (90 mm)	1 1/2" (38 mm)		1 19/32" x 5/8" x 1 11/32" (40 x 16 x 34 mm)	Max. 55 lb (25 kg)	
	5341190		1 31/32" (50 mm)	3 15/16" (100 mm)	1 7/8" (48 mm)	✓			
1.B	40790	Noir	1 31/32" (50 mm)	2 13/32" (61 mm)	1 27/32" (47 mm)		M8 x 15 mm	Max. 77 lb (35 kg)	
	50790		3 15/16" (100 mm)	4 19/32" (117 mm)	2 3/32" (53 mm)	✓			
	5341790		1 31/32" (50 mm)	2 7/8" (73 mm)	1 5/8" (41 mm)	✓			2 5/32" x 2 9/16" (55 x 65 mm)
3.	65024021204	Argent, noir	2 9/16" (65 mm)	1 3/4" (44 mm)	1 25/32" (46 mm)	✓	M8 X 19 mm	1 21/32" x 1 21/32" (42 x 42 mm)	
	66014031204		2 3/8" (60 mm)	3 9/32" (83 mm)	1 25/32" (46 mm)	✓			
	66024011203	Gris, blanc	2 3/8" (60 mm)	3 9/32" (83 mm)	1 25/32" (46 mm)	✓	M8 X 19 mm	1 21/32" x 1 21/32" (42 x 42 mm)	Max. 132 lb (60 kg)
	66024021203		2 3/8" (60 mm)	3 11/32" (85 mm)	1 25/32" (46 mm)	✓			
	66024011204	Argent, noir	2 3/8" (60 mm)	3 9/32" (83 mm)	1 25/32" (46 mm)	✓	M8 X 19 mm	1 21/32" x 1 21/32" (42 x 42 mm)	Max. 132 lb (60 kg)
	66024021204		2 3/8" (60 mm)	3 9/32" (83 mm)	1 25/32" (46 mm)	✓			
	66024011206	Gris, argent	2 3/8" (60 mm)	3 9/32" (83 mm)	1 25/32" (46 mm)	✓	M8 X 19 mm	1 21/32" x 1 21/32" (42 x 42 mm)	Max. 132 lb (60 kg)
	66024021206		2 3/8" (60 mm)	3 1/8" (79 mm)	1 25/32" (46 mm)	✓			
	66024021214	Argent, noir	2 3/8" (60 mm)	3 1/8" (79 mm)	1 25/32" (46 mm)	✓	M8 X 19 mm	1 21/32" x 1 21/32" (42 x 42 mm)	Max. 132 lb (60 kg)
	67524011204		2 15/16" (75 mm)	3 27/32" (98 mm)	2" (51 mm)	✓			
	67524021204	Gris, argent	2 15/16" (75 mm)	3 27/32" (98 mm)	1 27/32" (47 mm)	✓	M8 X 19 mm	1 31/32" x 1 31/32" (50 x 50 mm)	Max. 176 lb (80 kg)
	6752501206		2 15/16" (75 mm)	3 27/32" (98 mm)	1 27/32" (47 mm)	✓			
	4.	6704140	Chrome poli	1 31/32" (50 mm)	3 3/16" (81 mm)	1 31/32" (50 mm)		M8 x 25 mm	1 1/2" x 1 1/2" (38 x 38 mm)
6701140		1 31/32" (50 mm)		2 13/32" (61 mm)	1 31/32" (50 mm)				

*REQUIÈRENT :

Douille pour tige à bois. Produit no. : **612G**

Tous ces modèles ne laissent aucune trace au sol.

ROULETTES POUR PANNEAUX



finesse et subtilité

Conception **unidirectionnelle** parfaite pour des commodes, des petits lits et autres meubles



Discrète et fiable

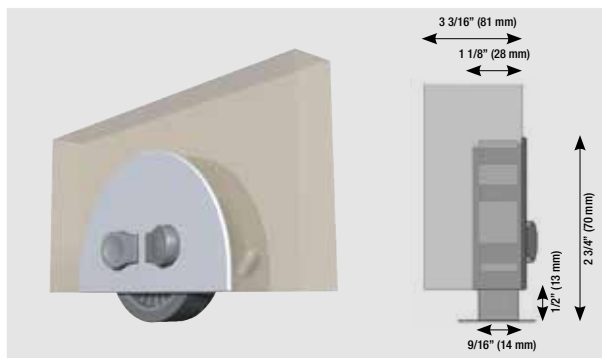

3 Droite et gauche



#	No.						
1.	809405010	Gris	2 3/8" (60 mm)	2 3/4" (70 mm)	✓	Max. 176 lb (80 kg)	Épais. de panneau : min. 1 3/16" (30 mm)
2.	80964022100	Gris	1 9/16" (40 mm)	1 11/16" (43 mm)		Max. 132 lb (60 kg)	Épais. de panneau : min. 7/8" (22 mm)
3.	80954018100	Gris	1 9/16" (40 mm)	2 5/32" (54 mm)	✓	Max. 110 lb (50 kg)	Épais. de panneau : de 3/4" à 1 3/16" (19-30 mm)

Tous ces modèles ne laissent aucune trace au sol.

DES FORMES,
DES FINIS ET
DES HAUTEURS
CONÇUS POUR
ACCENTUER
L'ÉCLAT
DES MEUBLES

patte de meuble



COMMENT CHOISIR UNE patte de meuble

Vous trouverez ici les critères à prendre en compte pour choisir une patte de meuble. Les pictogrammes présentés dans cette page vous aideront à comprendre les caractéristiques techniques des produits.



FINI



Que vous préfériez le style contemporain, rétro ou rustique, Richelieu vous propose une vaste gamme de modèles en différents finis et matériaux qui donneront de la personnalité à votre meuble. Ce symbole vous indiquera le fini de la patte.

HAUTEUR



La hauteur optimale dépendra de votre application.

HAUTEUR RÉGLABLE



Les pattes réglables offrent une marge de manoeuvre en ce qui a trait à la hauteur requise.

DIAMÈTRE OU DIMENSIONS

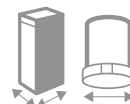

Indique soit le diamètre, soit la largeur et la profondeur de la patte.

TYPE DE FIXATION



Montage à tige ou à plaque. Les plaques varient en fonction du format de la patte. Pour un montage à tige, n'oubliez pas les douilles.

CAPACITÉ DE CHARGE / PATTE



Détermine le poids maximal pouvant être supporté par la patte. Il est important de tenir compte de ce qui sera posé sur le meuble ou la table pour calculer le poids total.

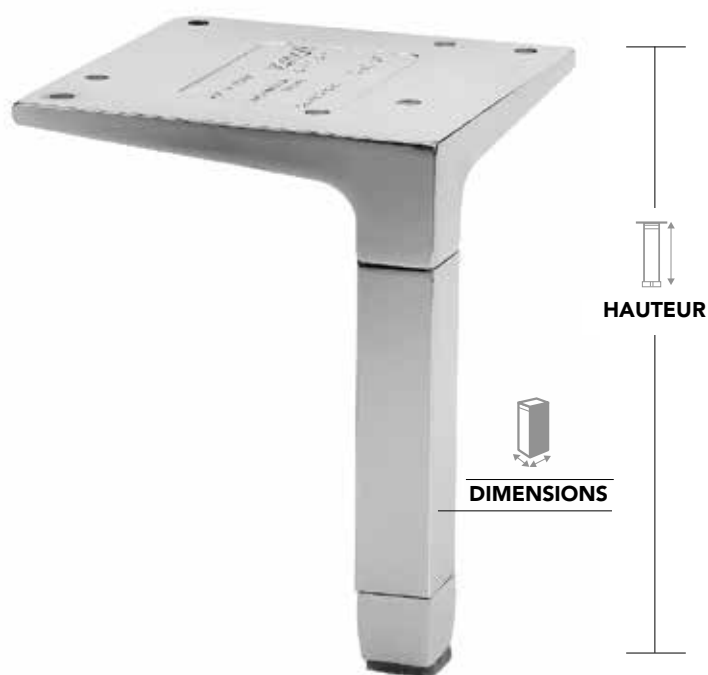





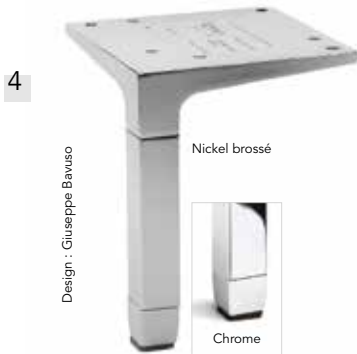

PATTES DE MEUBLE DESIGN

POUR DES MEUBLES DÉBORDANTS DE PERSONNALITÉ.



- 010, 10 - Aluminium
- 140 - Chrome
- 060 - Marron foncé
- 195 - Nickel satiné

PATTES RÉGLABLES

#	No.		 OU 			
1.	279175	10	Forme irrégulière	6 7/8" (175 mm)	13/32" (10 mm)	Max. 309 lb (140 kg)
2.	211100	010, 140, 060	1 31/32" x 15/32" (50 x 12 mm)	3 15/16" (100 mm)	3/16" (5 mm)	Max. 441 lb (200 kg)
3.	203100	010, 140, 060	1 31/32" x 9/32" (50 x 7 mm)	3 15/16" (100 mm)	9/32" (7 mm)	Max. 441 lb (200 kg)
	203140			5 1/2" (140 mm)		
	203200			7 7/8" (200 mm)		

PATTES À HAUTEUR FIXE

#	No.		 OU 		
4.	26120	140	23/32" (18 mm)	4 23/32" (120 mm)	Max. 353 lb (160 kg)
	261208	10			
5.	25175	195	Forme irrégulière	6 7/8" (175 mm)	Max. 231 lb (105 kg)



PATTES DE MEUBLE CONTEMPORAINES

Élégance et raffinement dans un style intemporel.







intemporel







PATTES RÉGLABLES

#	No.		 OU 			
1.	555100	900, 300, 170, 140	1 31/32" (49 mm)	3 15/16" (100 mm)	3/4" (19 mm)	Max. 772 lb (350 kg)
	555120			4 23/32" (120 mm)		
	555150			5 29/32" (150 mm)		
	555200			7 7/8" (200 mm)		
	555250			9 27/32" (250 mm)		
	555300			11 13/16" (300 mm)		
2.	804100	10	1 3/16" (30 mm)	3 15/16" (100 mm)	1/2" (13 mm)	Max. 88 lb (40 kg)
	804120			4 23/32" (120 mm)		
	804150			5 29/32" (150 mm)		
	804200			7 7/8" (200 mm)		

PATTES À HAUTEUR FIXE

#	No.		 OU 		
3.	64044130	140	7/16" x 2 11/32" (11 x 60 mm)	5 1/8" (130 mm)	Max. 132 lb (60 kg)

-  10 - Aluminium
-  140 - Chrome
-  170 - Acier inoxydable
-  300 - Blanc mat
-  900 - Noir mat

PATTES DE MEUBLE CONTEMPORAINES

















minimaliste
et raffinée

PATTE DE MEUBLE POLYVALENTE EN T OU EN L

Cette patte se fixe en T ou en L,
selon le résultat souhaité.









-  010 - Aluminium
-  030 - Blanc
-  060 - Marron foncé
-  135 - Bronze
-  140 - Chrome
-  900 - Noir mat

No.					
205100	010, 030, 060, 135, 140, 900		3 15/16" (100 mm)		Max. 441 lb (200 kg)
205120			4 23/32" (120 mm)		
205150	010, 030, 060, 135, 900		5 29/32" (150 mm)		Max. 19/32" (15 mm)
205200			7 7/8" (200 mm)		
205250			9 27/32" (250 mm)		
205300			11 3/4" (300 mm)		
205350			13 3/4" (350 mm)		



À vous de choisir !

PATTES RÉGLABLES





#	No.		 OU 			
1.*	107122	10	Forme irrégulière	4 3/4" (121 mm)	1/4" (6 mm)	Max. 176 lb (80 kg)
2.	40740	140,	Forme irrégulière	4 1/32" (103 mm)	5/16" (8 mm)	Max. 551 lb (250 kg)
	40760	195	Forme irrégulière	5 29/32" (150 mm)		Max. 1 102 lb (500 kg)



*REQUIERT :

1.A : Plaque de montage ronde, diam. 3" (76 mm) – 01751010

1.B : Tige de montage : M8 x 30 mm – 08302G

PATTES À HAUTEUR FIXE

#	No.		 OU 		
3.	22040	140	Forme irrégulière	5 1/2" (140 mm)	Max. 1 102 lb (500 kg)
4.	5301100	10	1 27/32" (47 mm)	3 15/16" (100 mm)	Max. 220 lb (100 kg)
5.	5303120	10	23/32" (18 mm)	4 23/32" (120 mm)	Max. 331 lb (150 kg)
6.	40720	195	Forme irrégulière	4 1/8" (105 mm)	Max. 551 lb (250 kg)

	10 - Aluminium
	140 - Chrome
	195 - Nickel

PATTES DE MEUBLE CONTEMPORAINES



1

Nette et moderne



2







3



4

épurée

PATTES À HAUTEUR FIXE

#	No.		 OU 		
1.	591150	74, 91, 195	Forme irrégulière	5 29/32" (150 mm)	Max. 110 lb (50 kg)
	915135100			4 3/16" (106 mm)	
2.	916135130	195	Forme irrégulière	5 11/32" (136 mm)	Max. 176 lb (80 kg)
	917135150			6 3/32" (155 mm)	
3.	25650100	91	1 31/32" (50 mm)	3 15/16" (100 mm)	Max. 220 lb (100 kg)
	25650150			195	
4.	238120	091, 195	Forme irrégulière	4 9/16" (116 mm)	Max. 110 lb (50 kg)

 74 - Chrome mat

 91, 091 - Nickel noir

 195 - Nickel brossé

élégante simplicité



PATTES À HAUTEUR FIXE

#	No.				
1.	91415030	195	1 3/16" (30 mm)	5 29/32" (150 mm)	Max. 176 lb (80 kg)
2.	64727100	10	1 1/2" (38 mm)	3 15/16" (100 mm)	Max. 331 lb (150 kg)
3.	91310038	195	1 1/2" (38 mm)	3 15/16" (100 mm)	Max. 176 lb (80 kg)
4.*	6302100	10	1 3/8" (35 mm)	3 15/16" (100 mm)	Max. 154 lb (70 kg)
	6302125			4 29/32" (125 mm)	
	6302150			5 29/32" (150 mm)	
5.	176138	106, 90, 195	1 1/2" (38 mm)	3 15/16" (100 mm)	Max. 110 lb (50 kg)

*REQUIÈRENT :

4.A : Plaque de montage – 2 3/4" x 2 3/4" (70 x 70 mm) – Gris – 7035106
 4.B : Base carrée – 2 5/32" x 2 5/32" x 1/2" (55 x 55 x 13 mm) – Aluminium satiné – 640410

PATTES RÉGLABLES

#	No.					
6.*	61758604	170	1 5/8" (41 mm)	4" (102 mm)	1 7/16" (37 mm)	Max. 2 000 lb (907 kg)
	61758606			6" (152 mm)		
7.	475120	140*	1 11/32" (35 mm)	4 23/32" (120 mm)	7/32" (5 mm)	Max. 441 lb (200 kg)
8.	64217050	140, 155, 170	31/32" (25 mm)	1 31/32" (50 mm)	13/32" (10 mm)	Max. 110 lb (50 kg)
	64217100			3 15/16" (100 mm)		
	64217150			5 29/32" (150 mm)		
	64217200			7 7/8" (200 mm)		

*REQUIÈRENT :

6.A : Plaque de montage (NSF) – 2 1/2" x 3 5/8" (64 x 92 mm) – Acier inoxydable – 61783512170
 6.B : Attache pour coup-de-pied (NSF) – Acier inoxydable – 61760000170

- 10 - Aluminium
- 90 - Noir
- 106 - Gris argenté
- 140 - Chrome
- 140* - Chrome poli
- 155 - Nickel satiné
- 170 - Acier inoxydable
- 195 - Nickel brossé

PATTES DE MEUBLE VINTAGE



le classique indémodable

PATTES RÉGLABLES

#	No.	  OU 			
1.	64134100	170, AB90, 290	1 3/8" (35 mm)	3 15/16" (100 mm)	Max. 154 lb (70 kg)
	64134150			5 29/32" (150 mm)	
	64134200			7 7/8" (200 mm)	
	64134250			9 27/32" (250 mm)	
2.	64130100	170, AB90, 290	1 21/32" (42 mm)	3 15/16" (100 mm)	Max. 154 lb (70 kg)
	64130150			5 29/32" (150 mm)	
	64130200			7 7/8" (200 mm)	
	64130250			9 27/32" (250 mm)	



-  AB90 - Laiton rustique
-  170 - Acier inoxydable
-  290 - Fer rustique



la finesse de l'aluminium

et l'élégance des courbes pour un style unique.

PATTES À HAUTEUR FIXE

#	No.			
1.A	560060	Aluminium brossé	4" (102 mm)	Max. 441 lb (200 kg)
	560050	Aluminium poli		
1.B	5600130	Aluminium poli	6" (152 mm)	Max. 441 lb (200 kg)
	5600140	Aluminium brossé		
1.C	5600100	Aluminium brossé	9 3/8" (238 mm)	Max. 441 lb (200 kg)
	560090	Aluminium poli		
2.	560070	Aluminium brossé	7 9/32" (185 mm)	Max. 441 lb (200 kg)
3.	5600124	Aluminium brossé	4" (102 mm)	Max. 441 lb (200 kg)
	5600125	Aluminium poli		
4.	5600110	Aluminium brossé	8" (203 mm)	Max. 441 lb (200 kg)
	5600120	Aluminium poli		
5.	5600280	Aluminium satiné	4" (102 mm)	Max. 441 lb (200 kg)
	5600290	Aluminium poli		

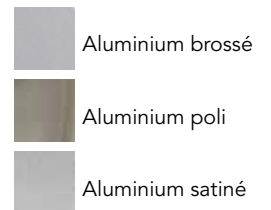

PATTES DE MEUBLE

Pratiques, fonctionnelles et réglables à la hauteur de votre choix.



1 2 options de montage et de hauteur



#	No.					
1.*	550100	10, 140, 170, 900	1 31/32" (50 mm)	3 15/16" (100 mm)	1 3/16" (30 mm)	Max. 331 lb (150 kg)
	550150			5 29/32" (150 mm)		

*OPTIONS :

1.A Plaque de fixation – 3 5/32" x 3 5/32" (80 x 80 mm) – Zinc – 5508122G

1.B Tige de fixation – M10 x 45 mm – Zinc – 5508682G

4 finis au choix



Aluminium



Chrome



Acier inoxydable



Noir mat

2 3 hauteurs de tube au choix

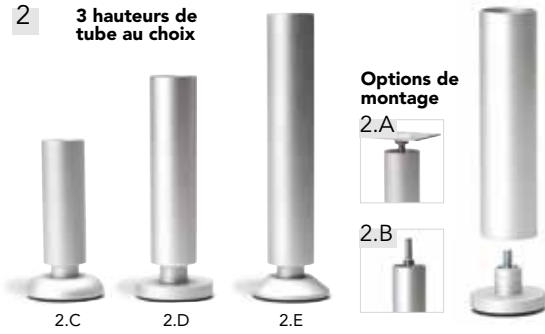

Options de montage



#	No.					
2.*	3807510	Aluminium	1 17/32" (38 mm)	2 15/16" (75 mm)	5/8" (16 mm)	Max. 154 lb (70 kg)
	3810010			3 15/16" (100 mm)		
	3815010			5 29/32" (150 mm)		

*OPTIONS :

2.A : Plaque de fixation – 2 7/16" x 1 31/32" (62 x 50 mm) – Gris – 5836106

2.B : Tige de fixation – M8 x 25 mm – 81252G

2.C : Base ronde – Hauteur : 1 1/32" (26 mm) – Diam. : 2 17/32" (64,5 mm) – Aluminium – 621210

2.D : Base rectangulaire – Hauteur : 1 1/4" (32 mm) – Diam. : 2 17/32" (65 mm) – Aluminium – 625110

2.E : Base triangulaire – Hauteur : 1 1/32" (26 mm) – Diam. : 2 17/32" (65 mm) – Aluminium – 624210

3 bases au choix



intemporel



Simple et gracieuse



#	No.		 OU 			
1.	6450715	140, 195	1 31/32" (50 mm)	5 29/32" (150 mm)	31/32" (25 mm)	Max. 154 lb (70 kg)
2.	6430210	140, 195	1 3/16" (30 mm)	3 15/16" (100 mm)	25/32" (20 mm)	Max. 110 lb (50 kg)
	6430212			4 23/32" (120 mm)		
	6430215			5 29/32" (150 mm)		
3.	6425610	140, 195	31/32" (25 mm)	3 15/16" (100 mm)	25/32" (20 mm)	Max. 110 lb (50 kg)
	6425612			4 23/32" (120 mm)		
	6425615			5 29/32" (150 mm)		

 140 - Chrome
 195 - Nickel

PATTES POUR LIT ET SOFA



Moderne. Épurée. Discrète.

1



2



3



4



PATTES À HAUTEUR FIXE

#	No.				
1.	6492730140	Chrome	7 3/32" x 3 15/16" (180 x 100 mm)	1 11/32" (34 mm)	Max. 220 lb (100 kg)
2.	94225032140	Chrome	9 27/32" (250 mm)	1 13/32" (36 mm)	Max. 176 lb (80 kg)
3.	7115056140	Chrome	5 29/32" (150 mm)	2 7/32" (56 mm)	Max. 176 lb (80 kg)
4.	95222040140	Chrome	1 9/16" x 8 21/32" (40 x 220 mm)	1 23/32" (44 mm)	Max. 176 lb (80 kg)

lignes pures



PATTES RÉGLABLES

#	No.					
1.	209040	010, 060, 140	3 5/32" (80 mm)	1 9/16" (40 mm)	3/16" (5 mm)	Max. 441 lb (200 kg)
2.	210060		3 5/32" (80 mm)	2 3/8" (60 mm)	3/16" (5 mm)	Max. 441 lb (200 kg)
3.	206016		2 11/32" (60 mm)	5/8" (16 mm)	3/16" (5 mm)	Max. 441 lb (200 kg)

	010 - Aluminium
	060 - Marron foncé
	140 - Chrome

PATTES DE MEUBLE EN ABS



1



2



3



4

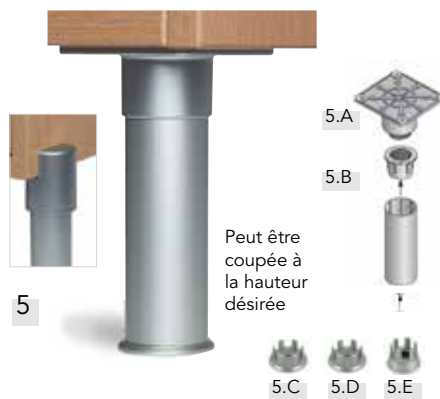

5



6

Peut être coupée à la hauteur désirée





robuste

#	No.		 OU 		
1.	45216010	Argent	2 11/32" (60 mm)	29/32" (23 mm)	Max. 661 lb (300 kg)
2.	45218010	Argent	Forme irrégulière	1 31/32" (50 mm)	Max. 441 lb (200 kg)
3.	684010	Argent	Forme irrégulière	3 5/32" (80 mm)	Max. 441 lb (200 kg)
4.	526900	Noir mat	Forme irrégulière	4 29/32" (125 mm)	Max. 441 lb (200 kg)
5.	15784010	Aluminium mat	1 5/8" (41 mm)	98 3/8" (2 500 mm) Peut être coupée à la hauteur désirée	Max. 441 lb (200 kg)
6.	15794010	Aluminium	1 5/8" (41 mm)		Max. 441 lb (200 kg)

Durable
Robuste
Légère
Fini épuré

*OPTIONS :

5.A : Plaque de fixation pour patte ronde en ABS : 3 1/8" x 3 1/8" (79 x 79 mm) – Aluminium – 45300110
5.B : Manchon fileté en ABS : Argent – 73303106
5.C : Embout de pied – Hauteur : 3/16" (5 mm) – Aluminium – 45115310
5.D : Embout de pied – Hauteur : 3/16" (5 mm) – Gris – 721153106
5.E : Embout de pied – Hauteur : 5/8" (16 mm) – Aluminium – 45115510
6.A : Plaque de fixation pour patte carrée en ABS : 1 5/8" x 1 5/8" (41 x 41 mm) – Gris – 74301106
6.B : Base pour patte en ABS : 1 5/8" x 1 5/8" (41 x 41 mm) – Argent – 45300810

TOUT UN ÉVENTAIL
DE STYLES : DESIGN,
VINTAGE, CONTEMPORAIN.
POUR DIFFÉRENTES
APPLICATIONS : TABLES
À MANGER, COMPTOIRS,
BARS, TABLES POUR
ENFANTS, BUREAUX, ETC.

pattes de table



COMMENT CHOISIR UNE patte de table

Vous trouverez ici les critères à prendre en compte pour choisir une patte de table. Les pictogrammes présentés dans cette page vous aideront à comprendre les caractéristiques techniques des produits.

MEUBLE ET HAUTEUR

- Pattes de table
25 5/8" à 28 1/2"
(650 à 724 mm)
- Pattes de comptoir
34 1/4" à 34 3/4"
(870 à 883 mm)
- Pattes de bar
40 1/8" à 40 3/4"
(1020 à 1040 mm)
- Pattes de table
pour enfants
14 3/4" à 23 1/32"
(375 à 585 mm)
- Pattes de table basse
14 3/4" (375 mm)
et moins

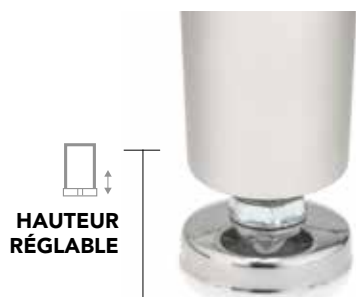

FINI



Que vous préférerez le style contemporain, rétro ou rustique, Richelieu vous propose une vaste gamme de modèles en différents finis et matériaux qui donneront de la personnalité à votre meuble ou à votre table. Ce symbole vous indiquera le fini de la patte.

HAUTEUR



La hauteur optimale dépendra de votre application.

HAUTEUR RÉGLABLE



Les pattes réglables ont l'avantage d'augmenter la polyvalence de votre application.

DIAMÈTRE OU DIMENSIONS

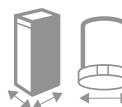

Indique soit le diamètre, soit la largeur et la profondeur de la patte.

TYPE DE FIXATION



Montage à tige ou à plaque. Les plaques varient en fonction du format de la patte. Pour un montage à tige, n'oubliez pas les douilles.

CAPACITÉ DE CHARGE / PATTE



Détermine le poids maximal pouvant être supporté par la patte. Il est important de tenir compte de ce qui sera posé sur la table pour calculer le poids total.

PATTES DE TABLE DESIGN







EN FORME DE LARME



DESIGN TRIANGULAIRE

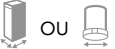

raffinée

#	No.	  OU 				Application	
1.A	643705	140, 170	1 31/32" (50 mm)	27 3/4" (705 mm)	13/32" (10 mm)	Max. 331 lb (150 kg)	Table
1.B	645705		3 5/32" (80 mm)				
1.C	644705		2 3/8" (60 mm)	34 1/4" (870 mm)			
	644870						
1.D	642705	010	3 15/16" (100 mm)	27 3/4" (705 mm)		Table	
2.	64671	010	2 3/8" (60 mm)	28" (710 mm)	13/32" (10 mm)	Max. 331 lb (150 kg)	Table
3.	63271	010	3 1/8" x 2" (79 x 51 mm)	27 1/2" (700 mm)	13/32" (10 mm)	Max. 331 lb (150 kg)	Table
4.	63371	010	4 1/4" x 3 1/8" (108 x 79 mm)	27 1/2" (700 mm)	13/32" (10 mm)	Max. 331 lb (150 kg)	Table

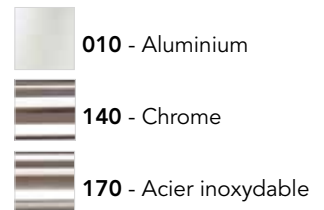





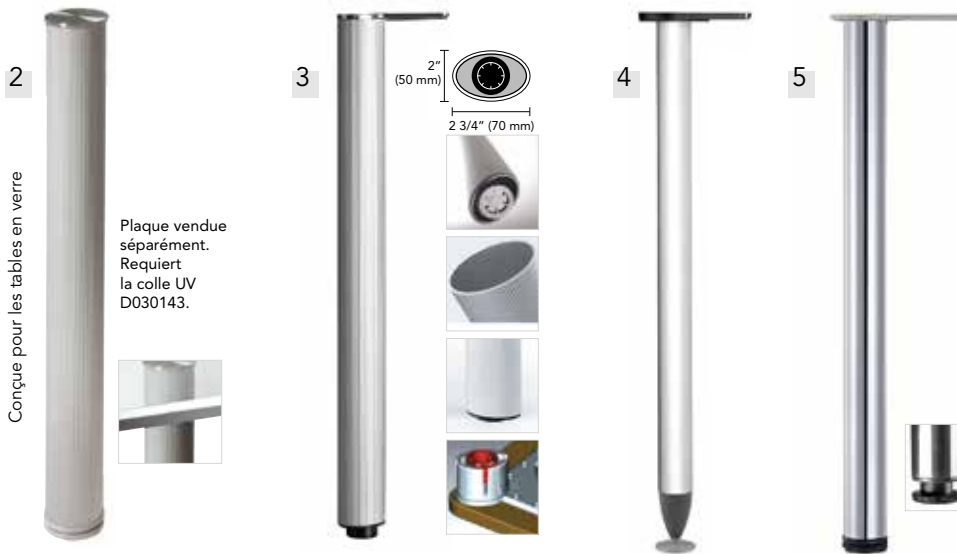

intemporel



QUADRATONDA
RONDE À LA BASE
ET CARRÉE EN HAUT



-  10 - Aluminium
-  090, 190 - Noir
-  100 - Gris
-  106 - Argent
-  140 - Chrome
-  175 - Nickel brossé
-  900 - Noir mat

#	No.	  OU 				Application
1.	618705	090, 100	1 31/32" (50 mm)	27 3/4" (705 mm)	1 3/16" (30 mm)	Max. 331 lb (150 kg) Table
2.*	612710	10	2 3/8" (60 mm)	28 11/32" (720 mm)	1 3/16" (30 mm)	Max. 331 lb (150 kg) Table
3.	637710	10	2 1/32" x 2 21/32" (52 x 68 mm)	27 1/2" (700 mm)	3/8" (10 mm)	Max. 331 lb (150 kg) Table
4.	612705	106	2" (51 mm)	27 3/4" (705 mm)	3/4" (19 mm)	Max. 331 lb (150 kg) Table
5.	620870	140, 900, 175	3 5/32" (80 mm)	34 1/4" (870 mm)	1 3/16" (30 mm)	Max. 331 lb (150 kg) Comptoir
	615110	140, 190, 175	2 3/8" (60 mm)	43 1/4" (1 100 mm)	1 3/16" (30 mm)	Max. 331 lb (150 kg) Bar





*OPTION :

2 : Capuchon en acier inoxydable : 2 9/16" x 33/64" (65 x 13 mm) – 81200170



PATTES DE TABLE CONTEMPORAINES



PATTES STRUCTURALES

#	No.						Application
1.	7525755702174	Chrome mat	2 31/32" x 15/16" (75 x 25 mm)	27 5/8" (702 mm)	29 23/32" (755 mm)	Max. 441 lb (200 kg)	Table
	7525603702174		23 3/4" (603 mm)				

TRAVERSES POUR PATTES STRUCTURALES

#	No.			Application
2.	75251371174	Chrome mat	54" (1 372 mm)	Table
	75251524174		60" (1 524 mm)	
	75251676174		65 31/32" (1 676 mm)	











lignes épurées

1









PATTES DE TABLE EN U

#	No.							Application
1.	8040900	Noir mat	3 5/32" x 1 9/16" (80 x 40 mm)	27 31/32" (710 mm)	24 1/32" (610 mm)	5/8" (16 mm)	Max. 441 lb (200 kg)	Table
	8040170	Acier inoxydable						

2



PATTES DE BANC



#	No.							Application
2.	80404900	Noir mat	3 5/32" x 1 9/16" (80 x 40 mm)	16 5/32" (410 mm)	14" (355 mm)	5/8" (16 mm)	Max. 441 lb (200 kg)	Banc
	80404170	Acier inoxydable						

PATTES DE TABLE CONTEMPORAINES

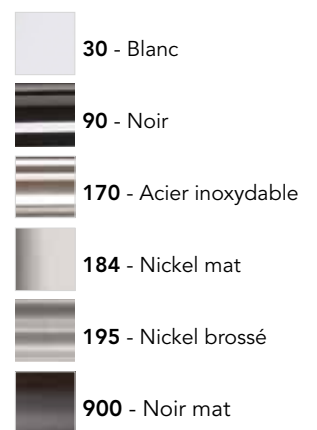

Solide
Élégante
Stylisée









#	No.		 OU 				Application
1.	UC330710	184	Forme irrégulière	28" (710 mm)	31/32" (25 mm)	Max. 265 lb (120 kg)	Table
2.	61758627	170	1 5/8" (41 mm)	27" (686 mm)	3 1/2" (89 mm)	Max. 2 000 lb (907 kg)	Table
3.	UC440710	30, 90, 170, 195, 900	1 37/64" (40 mm)	28" (710 mm)	31/32" (25 mm)	Max. 265 lb (120 kg)	Table
4.	UC150710	30, 90, 170, 195, 900	1 31/32" (50 mm)	28" (710 mm)	31/32" (25 mm)	Max. 265 lb (120 kg)	Table

PATTES DE TABLE VINTAGE

Pour des meubles de caractère.



#	No.		 OU 				Application
1.*	76912812	Acier	2 31/64" x 2 31/64" x 3 11/32" (63 x 63 x 85 mm)	28 13/64" (716 mm)	1/2" (13 mm)	Max. 400 lb (181 kg)	Table
	76913412			34 3/4" (883 mm)			Comptoir
	76914012			40 3/4" (1 040 mm)			Bar
2.*	76902812	Acier	3" (76 mm)	28 1/2" (724 mm)	1/2" (13 mm)	Max. 400 lb (181 kg)	Table
	76903412			34 3/4" (883 mm)			Comptoir
	76904012			40 3/4" (1 040 mm)			Bar
3.	5600220	Aluminium poli	Forme irrégulière	15 1/4" (387 mm)	—	Max. 198 lb (90 kg)	Table basse / Table pour enfants
	5600260	Aluminium brossé		29 1/2" (749 mm)			Table
4.	5600300	Aluminium satiné	Forme irrégulière	14 3/4" (375 mm)	—	Max. 198 lb (90 kg)	Table basse / Table pour enfants
	5600310	Aluminium poli					27 1/4" (692 mm)
	5600330	Aluminium brossé		27 1/4" (692 mm)			
	5600320	Aluminium poli					27 1/4" (692 mm)

* Commande minimale : 4

**l'audace de
l'authenticité**

POLYVALENTE AVEC STYLE

Un vaste choix de finis de qualité.



Épurée
Robuste
Polyvalente

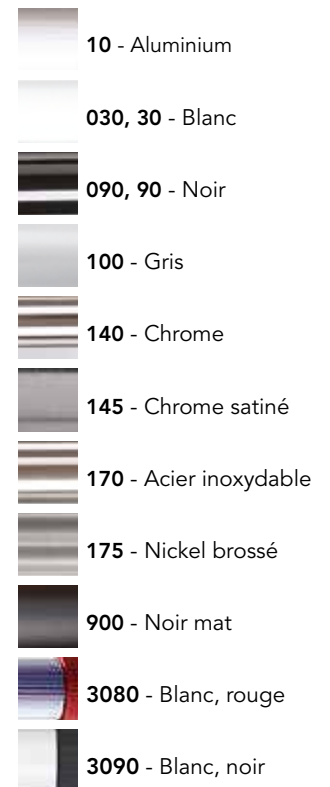

#	No.						Application
1.	615710	30, 90, 140, 170, 175	2 3/8" (60 mm)	27 1/2" (700 mm)	1 3/16" (30 mm)	Max. 331 lb (150 kg)	Table
	615870	30, 90, 140, 175	2 3/8" (60 mm)	34 1/4" (870 mm)	30 mm		Comptoir
	620120	145, 170	3 1/8" (79 mm)	40 1/8" (1 020 mm)			Bar
2.	620710	10, 30, 90, 140, 175, 900	3 5/32" (80 mm)	28" (710 mm)	1 3/16" (30 mm)	Max. 331 lb (150 kg)	Table
3.	620870	140, 175, 900	3 5/32" (80 mm)	34 1/4" (870 mm)	1 3/16" (30 mm)	Max. 331 lb (150 kg)	Comptoir
4.	614570	90	2 3/8" (60 mm)	22 1/2" (570 mm)	3 7/8" (98 mm)	Max. 331 lb (150 kg)	Table pour enfants
	61471	030, 090, 100		25 5/8" (650 mm)			Table
5.	61671	030, 090, 100	2 3/8" (60 mm)	27 1/2" (700 mm)	25/32" (20 mm)	Max. 331 lb (150 kg)	Table
6.	654	3080, 3090	2" (50 mm)	23" (584 mm)	7 1/8" (181 mm)	Max. 331 lb (150 kg)	Table pour enfants



fiabile

PATTES DE TABLE SÉRIE ZOOM



OPTIONS DE BASE POUR LES PIEDS ZOOM



Idéale pour tous les décors

#	No.						Application
1*	660710	140, 170, 900	2 3/8" (60 mm)	27 1/2" (700 mm)	3 15/16" (100 mm)	Max. 331 lb (150 kg)	Table
	660650			25 5/8" (650 mm)			Table

*OPTIONS :

A : Roulette pour pattes de série zoom – Hauteur : 2 7/8" (73 mm) – Noir mat – 66000190
B : Roulette pour pattes de série zoom – Hauteur : 4 3/4" (121 mm) – Noir mat – 66000290
C : Couvre-pattes pour la série zoom – Hauteur : 5 1/2" (140 mm) – Acier inoxydable – 6600010170
D : Couvre-pattes rondes pour la série zoom – Hauteur : 5 1/2" (140 mm) – Noir – 66000490

	140 - Chrome
	170 - Acier inoxydable
	900 - Noir mat



STARCK®

Les modèles Moebius de Philippe Starck se distinguent par leur esthétique soignée et leur performance impeccable. Fluidité du mouvement, surfaces sans démarcations, continuité des lignes sous tous les angles.



Tige à friction



Diamètre : 2 9/16" (65 mm)

Hauteur : 2 11/16" (68 mm)

Longueur de tige : 25/32" (20 mm)

Plaque : 1 27/32" x 1 27/32" (47 x 47 mm)

Cap. de charge dynamique/roulette : max. 110 lb (50 kg)

Avec plaque : 176543030 - Blanc, 176549090 - Noir, 1765414090 - Noir, chrome, 176543005 - Blanc, vert
Avec tige à friction : 176513030 - Blanc, 176519090 - Noir, 1765114090 - Noir, chrome, 176513005 - Blanc, vert

ROULETTES INDUSTRIELLES

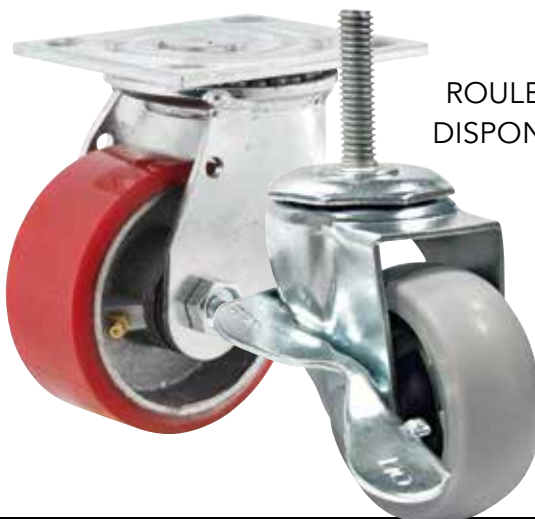

UN LARGE ÉVENTAIL DE ROULETTES INDUSTRIELLES EST DISPONIBLE SUR NOTRE SITE AU WWW.RICHELIEU.COM POUR RÉPONDRE À TOUTS VOS BESOINS



À votre service à travers l'Amérique du Nord

CANADA

Tél. : 1 800 361-6000

Télé. : 1 800 363-0193

ÉTATS-UNIS

Tél. : 1 800 619-5446

Télé. : 1 800 876-7454



Suivez-nous sur



LEG19FR 3e édition 10-2019
Imprimé au Canada 2\$