

## CARBIDE TIPPED SLOTTED DRIVE SYSTEM BROCAS PARA CONCRETO-SISTEMA SDS

**SLOTTED DRIVE SYSTEM PLUS** bits for hammer drills/rotary hammers are excellent for drilling the toughest concrete. Special designed carbide tips and spiral flutes combine to give the straightest drilling with the quickest removal of dust and chips in any position. In addition the special carbide tips & high grade steel body adds longer life to the bit. Available in cutting diameters from 5/32" to 1" with various usable lengths to 24" long.



**SLOTTED DRIVE SYSTEM MAX** bits are similar to our Slotted Drive System Plus bits, but are available in larger diameters. Special designed carbide tips and spiral flutes combine the straightest drilling with the quickest removal of dust and chips in any position. In addition the carbide tips and high grade steel body adds longer life to the bit. Available in cutting diameters from 3/8" to 1-1/2" with various usable lengths to 36" long.

## CARBIDE TIPPED **SLOTTED DRIVE SYSTEM MAX** BITS BROCAS PARA CONCRETO-SISTEMA SDS MAX

**SLOTTED DRIVE SYSTEM** Carbide tipped rotary hammer bits with 2 flute carbide tipped head for faster drilling of true round holes which produce less vibration for longer life and greater productivity.



**NEW**

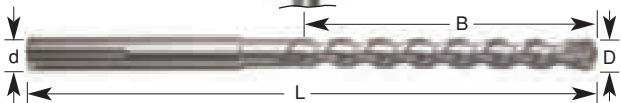
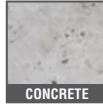

ØD	B	L	Tool No.
3/8"	8"	13"	613-400
1/2"	8"	13"	613-404
1/2"	16"	21"	613-408
9/16"	8"	13"	613-412
9/16"	16"	21"	613-416
5/8"	8"	13"	613-420
5/8"	16"	21"	613-424
5/8"	31"	36"	613-428
11/16"	16"	21"	613-432
3/4"	8"	13"	613-436
3/4"	16"	21"	613-440
3/4"	31"	36"	613-444
13/16"	16"	21"	613-448
7/8"	8"	13"	613-452
7/8"	16"	21"	613-456
1"	8"	13"	613-460
1"	16"	21"	613-464
1"	31"	36"	613-468
1-1/8"	10"	15"	613-472
1-1/8"	18"	23"	613-476
1-1/4"	10"	15"	613-480
1-1/4"	18"	23"	613-484
1-1/4"	31"	36"	613-488
1-3/8"	18"	23"	613-492
1-1/2"	18"	23"	613-496

Unit Pack: Individually Carded

## CARBIDE TIPPED **SLOTTED DRIVE SYSTEM PLUS** BITS BROCAS PARA CONCRETO-SISTEMA SDS PLUS

**SLOTTED DRIVE SYSTEM** Carbide tipped rotary hammer bits with 4 flute carbide tipped head for long drilling life with quick dust removal and greater accuracy under extreme loads.



**NEW**

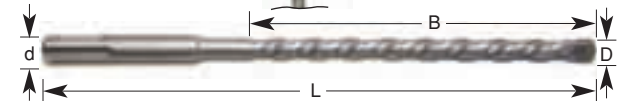
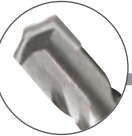

ØD	B	L	Tool No.
5/32"	2"	4"	613-100
5/32"	4"	6"	613-104
3/16"	2"	4"	613-108
3/16"	4"	6"	613-112
3/16"	6"	8"	613-116
3/16"	8"	10"	613-120
3/16"	10"	12"	613-124
7/32"	2"	4"	613-128
7/32"	6"	8"	613-132
7/32"	10"	12"	613-136
1/4"	2"	4"	613-140
1/4"	4"	6"	613-144
1/4"	6"	8"	613-148
1/4"	10"	12"	613-152
1/4"	12"	14"	613-156
5/16"	4"	6"	613-160
5/16"	6"	8"	613-162
5/16"	10"	12"	613-164
3/8"	4"	6"	613-168
3/8"	8"	10"	613-172
3/8"	10"	12"	613-176
3/8"	16"	18"	613-180
3/8"	22"	24"	613-184
7/16"	4"	6"	613-188
7/16"	10"	12"	613-192
1/2"	4"	6"	613-196
1/2"	8"	10"	613-200
1/2"	10"	12"	613-204
1/2"	16"	18"	613-208
1/2"	22"	24"	613-212
9/16"	4"	6"	613-216
9/16"	10"	12"	613-220
9/16"	16"	18"	613-224
5/8"	4"	6"	613-228
5/8"	6"	8"	613-232
5/8"	10"	12"	613-236
5/8"	16"	18"	613-240
5/8"	22"	24"	613-244
11/16"	6"	8"	613-248
3/4"	6"	8"	613-252
3/4"	10"	12"	613-256
3/4"	16"	18"	613-260
3/4"	22"	24"	613-264
7/8"	6"	8"	613-268
7/8"	10"	12"	613-272
7/8"	16"	18"	613-276
1"	8"	10"	613-280
1"	16"	18"	613-284

Unit Pack: Individually Carded

**MASONRY-HAMMER DRILL**  
**BROCA TALADRO-MARTILLO PARA CONCRETO**

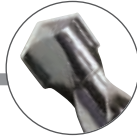

- Special carbide tips designed to withstand the impact of hammer drills
- Hardened steel body
- For use with hammer drills or rotary drills

ØD	Length	Tool No.
1/8"	3"	610-102
5/32"	4"	610-104
3/16"	4"	610-106
1/4"	4"	610-108
5/16"	4"	610-110
3/8"	4"	610-112
1/4"	6"	610-114
5/16"	6"	610-116
3/8"	6"	610-118
7/16"	6"	610-120
1/2"	6"	610-122
9/16"	6"	610-126
5/8"	6"	610-128
3/4"	6"	610-130
7/8"	6"	610-132
1"	6"	610-134
1/4"	13"	610-500
5/16"	13"	610-502
3/8"	13"	610-506
7/16"	13"	610-508
1/2"	13"	610-510
9/16"	13"	610-512
5/8"	13"	610-514
3/4"	13"	610-516
7/8"	13"	610-518
1"	13"	610-520

Unit Pack: Individually Carded

ØD	Length	Pcs. Per Pk.	Tool No.
1/8"	3"	10	610-602
5/32"	4"	10	610-604
3/16"	4"	10	610-606
1/4"	4"	10	610-608
5/16"	4"	10	610-610
3/8"	4"	10	610-612
1/4"	6"	10	610-614
5/16"	6"	10	610-616
3/8"	6"	10	610-618
7/16"	6"	10	610-620
1/2"	4"	5	610-621
1/2"	6"	10	610-622
9/16"	6"	5	610-626
5/8"	6"	5	610-628
3/4"	6"	5	610-630
7/8"	6"	3	610-632
1"	6"	3	610-634
1/4"	13"	10	610-700
5/16"	13"	10	610-702
3/8"	13"	10	610-706
7/16"	13"	10	610-708
1/2"	13"	10	610-710
9/16"	13"	5	610-712
5/8"	13"	5	610-714
3/4"	13"	5	610-716
7/8"	13"	3	610-718
1"	13"	3	610-720

NOTE: All sizes over 3/8" diameter have a reduced shank of 3/8" diameter.  
 Unit Pack: Bulk

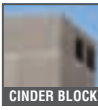
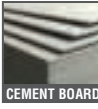

**MULTI-PURPOSE DRILL BITS**  
**BROCA MULTIUSO**

**NEW**



This extremely hard tungsten carbide tip is excellent for use in concrete, marble, cast iron, (wood), ceramic and plastics.

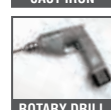
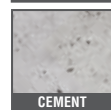
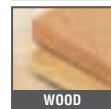

ØD	Ød	L	Pcs. Per Pk.	Tool No.
1/8"	1/8"	2-3/8"	3	606-170
5/32"	5/32"	2-15/16"	1	606-172
3/16"	3/16"	3-5/16"	1	606-174
1/4"	1/4"	3-15/16"	1	606-176
9/32"	9/32"	3-15/16"	1	606-178
5/16"	5/16"	4-3/4"	1	606-180
3/8"	3/8"	4-3/4"	1	606-182
7/16"	3/8"	5-7/8"	1	*606-184
1/2"	3/8"	5-7/8"	1	*606-186
4 piece set 1/8, 3/16, 1/4, 5/16			1 of each	606-190

Unit Pack: Individually Carded  
 \*Please note these bits have a reduced shank  
**NOT RECOMMENDED** for use on angle iron, stainless steel, galvanized pipe and soft metals (ie: aluminum, brass, copper).

## COBALT DRILL BITS BROCAS CON RECUBRIMIENTO DE COBALTO

**NEW**

- Heat resistance treated
- Designed for drilling in extremely hard and abrasive materials like cast iron, titanium and stainless steel.

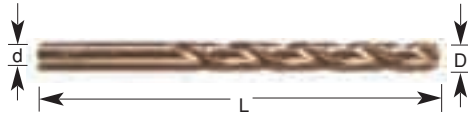

ØD	Ød	L	Packed Quality	Tool No.
1/32"	1/32"	1-3/8"	10	611-200
3/64"	3/64"	1-3/4"	10	611-202
1/16"	1/16"	1-7/8"	10	611-204
5/64"	5/64"	2"	10	611-206
3/32"	3/32"	2-1/4"	10	611-208
7/64"	7/64"	2-5/8"	10	611-210
1/8"	1/8"	2-3/4"	10	611-212
9/64"	9/64"	2-7/8"	10	611-214
5/32"	5/32"	3-1/8"	10	611-216
3/16"	3/16"	3-1/2"	10	611-218
7/32"	7/32"	3-3/4"	10	611-219
1/4"	1/4"	4"	10	611-220
9/32"	9/32"	4-1/4"	5*	611-221
5/16"	5/16"	4-1/2"	5*	611-222
3/8"	3/8"	5"	5*	611-224
7/16"	3/8"	5"	5*	611-226
1/2"	3/8"	5"	5*	611-228
9/16"	3/8"	5"	5*	611-230

Unit Pack: Bulk 10 / **Empaque Al Granel - 10pzs.**  
Unit Pack: Bulk 5\* / **Empaque Blister - 5pzs.**

## HIGH-SPEED STEEL DRILL BROCA DE ACERO DE ALTA VELOCIDAD

- Precision ground for drilling in wood, plastic and metal
- 135° split point designed for easy starting
- Drills faster than regular high speed steel drills
- Black oxide finish

ØD	Pcs. Per Pk.	Tool No.
1/32"	3	611-100
3/64"	3	611-102
1/16"	3	611-104
5/64"	3	611-106
3/32"	3	611-108
7/64"	3	611-110
1/8"	3	611-112
9/64"	1	611-114
5/32"	1	611-116
11/64"	1	611-118
3/16"	1	611-120
13/64"	1	611-122
7/32"	1	611-124
15/64"	1	611-126
1/4"	1	611-128
17/64"	1	611-130
9/32"	1	611-132
19/64"	1	611-134
5/16"	1	611-136
21/64"	1	611-138
11/32"	1	611-140
23/64"	1	611-142
3/8"	1	611-144
25/64"	1	611-146
13/32"	1	611-148
27/64"	1	611-150
7/16"	1	611-152
29/64"	1	611-154
15/32"	1	611-156
31/64"	1	611-158
1/2"	1	611-162
9/16"	1	611-168

Unit Pack: Individually Carded  
**Empaque Blister**

ØD	Pcs. Per Pk.	Tool No.	ØD	Pcs. Per Pk.	Tool No.
1/32"	10	611-500	9/32"	10	611-532
3/64"	10	611-502	19/64"	5*	611-534
1/16"	10	611-504	5/16"	5*	611-536
5/64"	10	611-506	21/64"	5*	611-538
3/32"	10	611-508	11/32"	5*	611-540
7/64"	10	611-510	23/64"	5*	611-542
1/8"	10	611-512	3/8"	5*	611-544
9/64"	10	611-514	25/64"	5*	611-546
5/32"	10	611-516	13/32"	5*	611-548
11/64"	10	611-518	27/64"	5*	611-550
3/16"	10	611-520	7/16"	5*	611-552
13/64"	10	611-522	29/64"	5*	611-554
7/32"	10	611-524	15/32"	5*	611-556
15/64"	10	611-526	31/64"	5*	611-558
1/4"	10	611-528	1/2"	5*	611-562
17/64"	10	611-530	9/16"	5*	611-568

Unit Pack: Bulk 10 / **Empaque Al Granel - 10pzs.**  
Unit Pack: Bulk 5\* / **Empaque Al Granel - 5pzs.**  
NOTE: All sizes over 3/8" diameter have a reduced shank of 3/8" diameter.

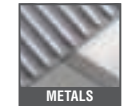

**BRAD POINT DRILL**

**BROCA DE PUNTILLA PARA MADERA**

**NEW**  
ADDITIONAL SIZES



**PRECISION WOOD CUTTING BITS**

Brad Point drill bits are the bits of choice for precision wood cutting. They overcome the tendency to walk at the start of a hole and reduce tearout at the perimeter of the hole. The bits are made from high speed steel. They are fully ground and polished to give superior chip clearance.

We carry an extensive line of individual sizes ranging from 1/16" to 1". Our 7 piece set (606-200) is available with 7 of the most popular sizes 1/8", 3/16", 1/4", 5/16", 3/8", 7/16", 1/2".

**606-200**  
7pc. Brad Point  
Drill Bit Set



ROTARY DRILL



ØD	Ød	L	Tool No.
1/16"	1/16"	1-7/8"	606-100
5/64"	5/64"	2"	606-102
3/32"	3/32"	2-1/4"	606-104
7/64"	7/64"	2-5/8"	606-106
1/8"	1/8"	2-3/4"	606-108
9/64"	9/64"	2-7/8"	606-110
5/32"	5/32"	3-1/8"	606-112
11/64"	11/64"	3-1/4"	606-114
3/16"	3/16"	3-1/2"	606-116
5MM	5MM	3-5/16"	606-117
13/64"	13/64"	3-5/8"	606-118
7/32"	7/32"	3-3/4"	606-120
15/64"	15/64"	3-7/8"	606-122
6MM	6MM	3-9/16"	606-123
1/4"	1/4"	4"	606-124
17/64"	17/64"	4-1/8"	606-126
9/32"	9/32"	4-1/4"	606-128
19/64"	19/64"	4-3/8"	606-130
5/16"	5/16"	4-1/2"	606-132
8MM	8MM	4-7/16"	606-133
21/64"	21/64"	4-5/8"	606-134
11/32"	11/32"	4-3/4"	606-136
23/64"	23/64"	4-7/8"	606-138
3/8"	3/8"	5"	606-140
25/64"	3/8"	5-1/8"	606-142
13/32"	3/8"	5-1/4"	606-144
27/64"	3/8"	5-3/8"	606-146
7/16"	3/8"	5-1/2"	606-148
29/64"	3/8"	5-5/8"	606-150
15/32"	3/8"	5-3/4"	606-152
31/64"	3/8"	5-7/8"	606-154
1/2"	3/8"	6"	606-156
5/8"	1/2"	6-5/8"	606-158
3/4"	1/2"	7-3/4"	606-160
7/8"	1/2"	8-1/4"	606-162
1"	1/2"	8-3/4"	606-164
7pc. Brad Point Drill Set in Metal Box			606-200

Unit Pack: Individually Carded

**TITANIUM COATED STEP DRILL**

**BROCA ESCALONADA CON RECUBRIMIENTO DE TITANIO**

**NEW**

Excellent for cutting in copper, brass, aluminum, metal, sheet metal, plastics, wood and wood veneers up to 1/8" thick.

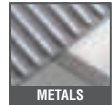

METALS



WOOD



PLASTIC

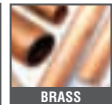

BRASS



ROTARY DRILL

ØD	Increments	Step Depth	Ød	Tool No.
1/8" - 1/2"	1/32"	1/8"	1/4"	608-780
3/16" - 7/8"	1/16"	1/8"	1/4"	608-782
9/16" - 1"	1/8"	1/8"	3/8"	608-784

Unit Pack: Individually Carded

**7 PC. SPLIT RING DEPTH STOP SET**

**JUEGO 7 PZS. ANILLOS DE TOPE**

**NEW**



Drill bits not included.

Description	Tool No.
7 pc. set: 1/8", 3/16", 1/4", 5/16", 3/8", 7/16" & 1/2"	4020

Hex wrench included.  
Unit Pack: Individually Carded

## BI-METAL HOLE SAW SIERRA COPA BI-METALICA

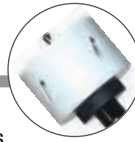

- Precision-sharpened teeth for smooth, fast cuts
- Cuts clean holes in wood, plastic, metal & gypsum boards
- Lasts up to 5 times longer than carbon steel hole saws
- Ideal for carpenters, electricians and plumbers

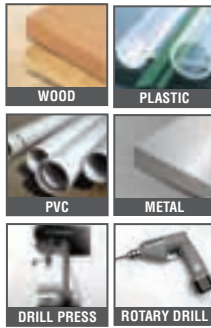

Diameter		Cutting Depth		Mandrel	Tool No.
Inch	MM	Inch	MM		
5/8"	16MM	2-1/8"	54MM	602-330, 602-334, 602-336	<b>602-100</b>
11/16"	17MM	2"	51MM	602-330, 602-334, 602-336	<b>602-102</b>
3/4"	19MM	2"	51MM	602-330, 602-334, 602-336	<b>602-104</b>
13/16"	21MM	2"	51MM	602-330, 602-334, 602-336	<b>602-106</b>
7/8"	22MM	2"	51MM	602-330, 602-334, 602-336	<b>602-108</b>
15/16"	24MM	2"	51MM	602-330, 602-334, 602-336	<b>602-110</b>
1"	25MM	2"	51MM	602-330, 602-334, 602-336	<b>602-112</b>
1-1/16"	27MM	2"	51MM	602-330, 602-334, 602-336	<b>602-114</b>
1-1/8"	29MM	2"	51MM	602-330, 602-334, 602-336	<b>602-116</b>
1-3/16"	30MM	2"	51MM	602-330, 602-334, 602-336	<b>602-118</b>
1-1/4"	32MM	2"	51MM	602-332, 602-338	<b>602-120</b>
1-5/16"	33MM	2"	51MM	602-332, 602-338	<b>602-122</b>
1-3/8"	35MM	2"	51MM	602-332, 602-338	<b>602-124</b>
1-7/16"	37MM	1-3/4"	44MM	602-332, 602-338	<b>602-126</b>
1-1/2"	38MM	1-3/4"	44MM	602-332, 602-338	<b>602-128</b>
1-9/16"	40MM	1-3/4"	44MM	602-332, 602-338	<b>602-130</b>
1-5/8"	41MM	1-3/4"	44MM	602-332, 602-338	<b>602-132</b>
1-11/16"	43MM	1-3/4"	44MM	602-332, 602-338	<b>602-134</b>
1-3/4"	44MM	1-3/4"	44MM	602-332, 602-338	<b>602-136</b>
1-7/8"	48MM	1-3/4"	44MM	602-332, 602-338	<b>602-138</b>
2"	51MM	1-3/4"	44MM	602-332, 602-338	<b>602-140</b>
2-1/16"	52MM	1-3/4"	44MM	602-332, 602-338	<b>602-142</b>
2-1/8"	54MM	1-3/4"	44MM	602-332, 602-338	<b>602-144</b>
2-1/4"	57MM	1-3/4"	44MM	602-332, 602-338	<b>602-146</b>
2-5/16"	59MM	1-3/4"	44MM	602-332, 602-338	<b>602-148</b>
2-3/8"	60MM	1-3/4"	44MM	602-332, 602-338	<b>602-150</b>
2-1/2"	64MM	1-3/4"	44MM	602-332, 602-338	<b>602-152</b>
2-9/16"	65MM	1-3/4"	44MM	602-332, 602-338	<b>602-154</b>
2-5/8"	67MM	1-3/4"	44MM	602-332, 602-338	<b>602-156</b>
2-3/4"	70MM	1-3/4"	44MM	602-332, 602-338	<b>602-158</b>
2-7/8"	73MM	1-3/4"	44MM	602-332, 602-338	<b>602-160</b>
3"	76MM	1-3/4"	44MM	602-332, 602-338	<b>602-162</b>
3-1/8"	79MM	1-3/4"	44MM	602-332, 602-338	<b>602-164</b>
3-1/4"	83MM	1-3/4"	44MM	602-332, 602-338	<b>602-166</b>
3-3/8"	86MM	1-3/4"	44MM	602-332, 602-338	<b>602-168</b>
3-1/2"	89MM	1-3/4"	44MM	602-332, 602-338	<b>602-170</b>
3-5/8"	92MM	1-3/4"	44MM	602-332, 602-338	<b>602-172</b>
3-3/4"	95MM	1-3/4"	44MM	602-332, 602-338	<b>602-174</b>
3-7/8"	99MM	1-3/4"	44MM	602-332, 602-338	<b>602-176</b>
4"	102MM	1-3/4"	44MM	602-332, 602-338	<b>602-178</b>
4-1/8"	105MM	1-3/4"	44MM	602-332, 602-338	<b>602-180</b>
4-1/2"	114MM	1-3/4"	44MM	602-332, 602-338	<b>602-182</b>
4-3/4"	121MM	1-3/4"	44MM	602-332, 602-338	<b>602-184</b>
5"	127MM	1-3/4"	44MM	602-332, 602-338	<b>602-186</b>
6"	152MM	1-3/4"	44MM	602-332, 602-338	<b>602-188</b>

Unit Pack: Individually Carded

## BI-METAL HOLE SAW MANDRELS MANDRIL PARA SIERRA COPA

- To be used in conjunction with our bi-metal hole saws
- 1/4" high speed steel pilot drill included

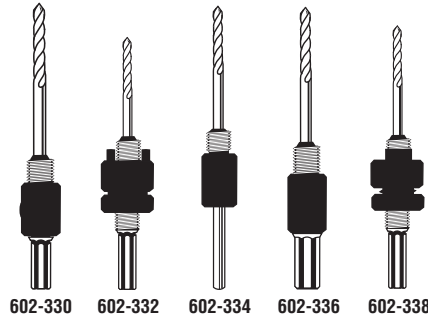

Shank Size	Fits Hole Saw Size	Chuck Size	Tool No.
3/8" Hex	9/16" - 1-3/16"	3/8"	<b>602-330</b>
7/16" Hex	1-1/4" - 6"	1/2"	<b>602-332</b>
1/4" Round	9/16" - 1-3/16"	1/4"	<b>602-334</b>
7/16" Hex	9/16" - 1-3/16"	1/2"	<b>602-336</b>
7/16" Hex	1-1/4" - 6"	3/8"	<b>602-338</b>

Unit Pack: Individually Carded

Bi-Metal Replacement Pilot Drills:  
Broca Guia Para Mandril de Sierra Copa Bi-Metalica:

Tool No.	Size	Fits Madrel
<b>602-200</b>	1/4" x 4"	602-334
<b>602-202</b>	1/4" x 3"	602-330, 602-332, 602-336, 602-338

## DOWEL CENTER SET

**NEW**

### JUEGO DE PUNTAS METALICAS PARA CENTRAR CLAVIJAS

8 piece metal dowel centers for lining up dowels accurately.

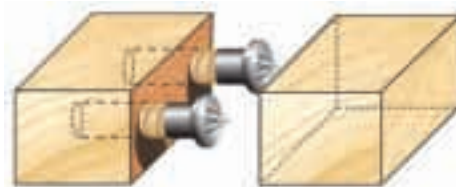

Description	Tool No.
8 pc. set: (2)1/4", (2)5/16", (2)3/8", (2)1/2"	<b>608-104</b>

Unit Pack: Individually Carded

# QUICK RELEASE DRILL SYSTEM

SISTEMA DE CAMBIO RAPIDO PARA TALADRO

All Quick Release Accessories have 1/4" hex shank for "quick release" type chucks.

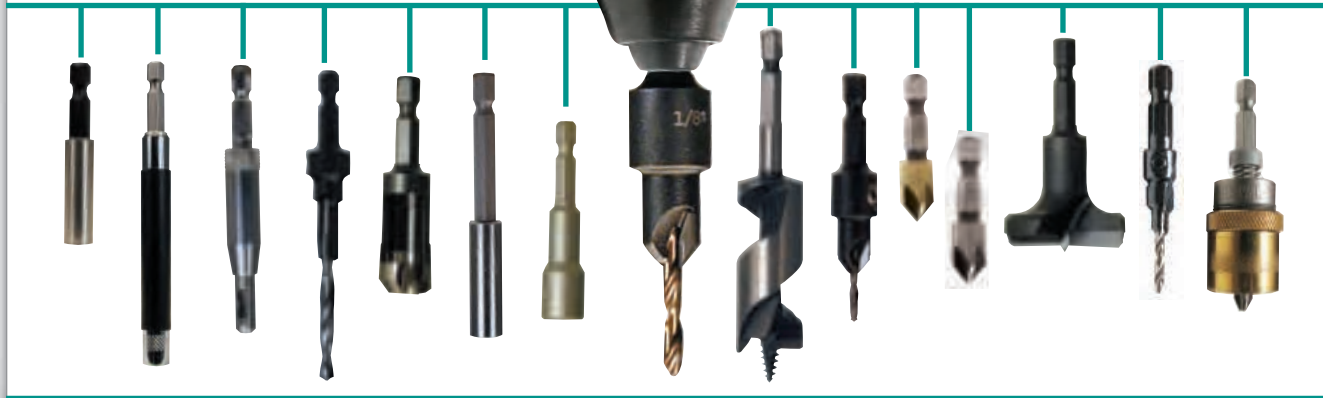

**QUICK RELEASE DRILLING & BORING**

## QUICK RELEASE KEYLESS CHUCK MANDRIL/BROQUERO SIN LLAVE

### 1/4" HEX SHANK

A great product featuring a patented quick-release mechanism that makes instant tool changes simple and fast. Works with our countersink and drill bit accessories or any 1/4" hex power bit.

Solid steel construction, knurled locking collar and no-slip 3/8" hex shank to fit in any drill, cordless drill or drill press with 3/8" or larger chuck or keyless chuck.



ØD	Ød	Tool No.
1/4"	3/8"	608-100

Unit Pack: Individual Clamshell

## DRILL ADAPTERS w/TAPER POINT DRILLS ADAPTADOR CAMBIO RAPIDO CON BROCA ESCALONADA

### 1/4" HEX SHANK • WITH QUICK CHANGE ADAPTER



ØD MM	ØD Inch	L	Repl. Drill Bit	Tool No.
2.0MM	5/64"	3"	630-260	608-260
2.4MM	3/32"	3-9/32"	630-262	608-262
2.8MM	7/64"	3-9/32"	630-264	608-264
3.2MM	1/8"	3-3/8"	630-266	608-266
3.6MM	9/64"	3-7/16"	630-268	608-268
4.0MM	5/32"	3-7/16"	630-270	608-270
4.4MM	11/64"	4"	630-272	608-272
4.8MM	3/16"	4-9/32"	630-274	608-274
5.6MM	7/32"	5"	630-276	608-276
6.3MM	1/4"	5-5/16"	630-278	608-278

Unit Pack: Individually Carded

## DRILL ADAPTERS WITH DRILL BITS ADAPTADOR CAMBIO RAPIDO CON BROCA

Includes HSS twist drill bit. You can also use these adapters with brad point, tapered, split point and any other type of drill bit.

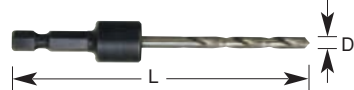

ØD	L	Repl. Drill Bit	Tool No.
5/64"	3-3/4"	630-001	608-200
3/32"	3-3/4"	630-002	608-202
7/64"	3-3/4"	630-098	608-204
1/8"	3-3/4"	630-102	608-206
9/64"	3-3/4"	630-802	608-208
5/32"	3-3/4"	630-202	608-210
11/64"	3-3/4"	630-302	608-212
3/16"	3-3/4"	630-402	608-214
7/32"	4"	630-502	608-216
15/64"	4"	630-602	608-218
1/4"	4"	630-702	608-220

Unit Pack: Individually Carded

## RTA FURNITURE DRILLS/COUNTERSINKS AVELLANADOR CAMBIO RAPIDO CON BROCA PARA TORNILLOS DE MUEBLES

### 1/4" HEX SHANK

RTA furniture step drill. Used for drilling pilot hole, clearance hole and countersinking.

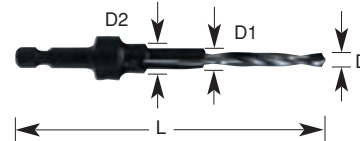

ØD Drill Size	ØD1 RTA Screw Size	ØD2 Countersink Dia.	Tool No.
3.5MM	5.0MM	7.0MM	608-150
5.0MM	7.0MM	10.0MM	608-152

Replacement 3.5MM HSS slow spiral drill bit, 2-3/4" long, #55104.  
Replacement 5.0MM HSS slow spiral drill bit, 3-7/16" long, #55105.  
Replacement #10-24 set screw, #67092 (requires #5000 3/32" hex key).

Unit Pack: Individually Carded

**CARBIDE TIPPED COUNTERSINKS**

AVELLANADOR CON PUNTAS DE CARBURO (INCLUYE BROCA)

**1/4" HEX SHANK**

Drill pilot hole and tapered countersink for wood screws. Carbide tipped for long lasting results in hardwood, plywood, plastics, etc.

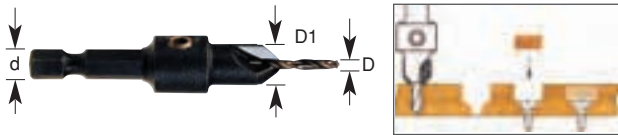

ØD	*Wood Screw Size	ØD1 Countersink Dia.	Tool No.
5/64"	#4	3/8"	608-110
3/32"	#6	3/8"	608-112
7/64"	#8	3/8"	608-114
1/8"	#10	3/8"	608-116
9/64"	#12	1/2"	608-118

\*Recommended wood screw sizes represent general purpose applications. Harder or softer materials may require different size pilot holes.

Unit Pack: Individually Carded

**CARBIDE TIPPED BORING**

BROCA CON PUNTAS DE CARBURO PARA BISAGRAS EUROPEAS

**1/4" HEX SHANK**

Drill pilot hole and tapered countersink for wood screws. Carbide tipped for long lasting results in hardwood, plywood, plastics, etc.

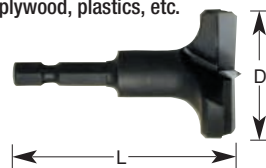

ØD	L	Tool No.
15MM	55MM	608-170
20MM	55MM	608-172
25MM	55MM	608-174
26MM	55MM	608-176
30MM	55MM	608-178
35MM	55MM	608-180

Unit Pack: Individually Carded

**DEPTH STOPS FOR COUNTERSINKS**

ANILLOS DE TOPES

**1/4" HEX SHANK**

Adjustable to control the depth of countersinks listed in above table.

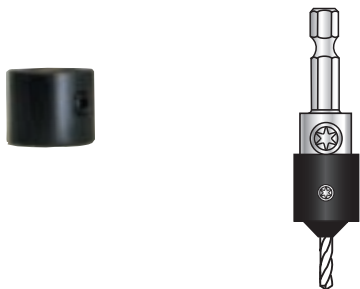

Fits the Following Countersinks	Tool No.
608-110, 608-112, 608-114, 608-116	608-120
608-118	608-122

Unit Pack: Individually Carded

**HSS COUNTERSINKS**

AVELLANADOR DE ACERO ALTA VELOCIDAD (INCLUYE BROCA)

**NEW**

**1/4" HEX SHANK**

Individual HSS countersinks designed for screw sizes #4-12. Adjustable to control the depth of countersinks listed in above table.



Screw Size #	ØD	Tool No.
4-5	5/64"	608-140
6-7	3/32"	608-142
8-9	7/64"	608-144
10	1/8"	608-146
12	9/64"	608-148

Unit Pack: Individually Carded

Replacement Parts:

Tool No.	Replacement Drill Bit
608-140	630-001
608-142	630-002
608-144	630-098
608-146	630-102
608-148	630-802

**CARBIDE TIPPED COUNTERBORES**

AVELLANADOR CON PUNTAS DE CARBURO (INCLUYE BROCA)

**1/4" HEX SHANK**

Flat bottom counterbores for using round head screws, hex bolts, etc. Includes pilot drill.

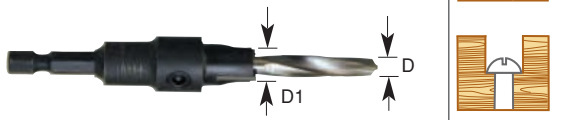

ØD	ØD1 Counterbore Dia.	Tool No.
5/32"	3/8"	608-130
3/16"	3/8"	608-132
3/16"	1/2"	608-134
1/4"	1/2"	608-136
1/4"	5/8"	608-138

Unit Pack: Individually Carded

**PLUG CUTTERS**

CORTADOR DE TAPONES PARA MADERA

**NEW**  
ADDITIONAL SIZES

**1/4" HEX SHANK**

Self ejecting style for making your own wood plugs. 3/8" size is #4 through #10 screws and 1/2" is for #12 screws.

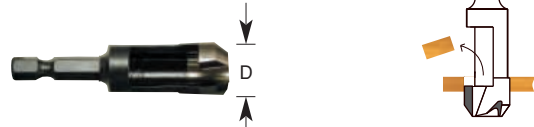

ØD	Tool No.
1/4"	608-251
3/8"	608-250
10MM	608-252
1/2"	608-254
5/8"	608-256
1/4", 3/8", 1/2", 5/8"	4 Pc. Set 608-258

Unit Pack: Individually Carded

**82° HSS COUNTERSINKS**  
AVELLANADOR HSS M2-82 GRADOS

**NEW**

**1/4" HEX SHANK**

5 flute, precision ground M2 high speed steel.

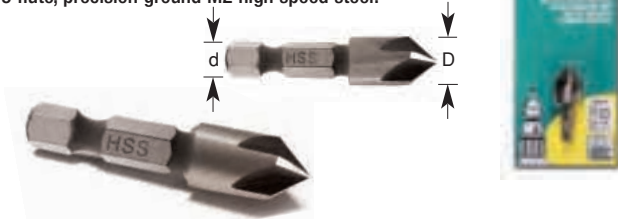

ØD	d	Tool No.
1/4"	1/4"	608-760
5/16"	1/4"	608-761
3/8"	1/4"	608-762
1/2"	1/4"	608-763
5/8"	1/4"	608-764
3/4"	1/4"	608-765

Unit Pack: Individually Carded

**CARBIDE TIPPED GLASS & TILE DRILLS**

BROCAS CON PUNTAS DE CARBURO PARA VIDRIO, AZULESO, LOZA Y PORCELANA

**NEW**  
ADDITIONAL SIZES

**1/4" HEX SHANK**

With the unique spear-point tungsten carbide tip, these bits will cut a perfectly round hole without chipping or breaking. For drilling glass and ceramic tile.

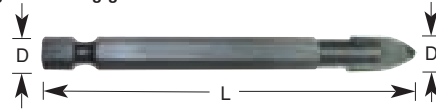

ØD MM	ØD Inch	d	L	Tool No.
3MM	1/8"	1/4"	2-1/4"	608-290
4MM	5/32"	1/4"	2-1/4"	608-292
5MM	3/16"	1/4"	2-9/16"	608-294
6MM	1/4"	1/4"	2-7/8"	608-296
8MM	5/16"	1/4"	3-1/8"	608-298
10MM	3/8"	1/4"	3-3/4"	608-300
12MM	1/2"	1/4"	3-3/4"	608-302
4 piece set 1/8", 3/16", 1/4", 5/16"				608-304

Unit Pack: Individually Carded

**82° TITANIUM COATED HSS COUNTERSINKS**  
AVELLANADOR HSS M2-82 GRADOS CON RECUBRIMIENTO DE TITANIO

**NEW**

**1/4" HEX SHANK**

5 flute, titanium nitrate coated, precision ground M2 high speed steel.

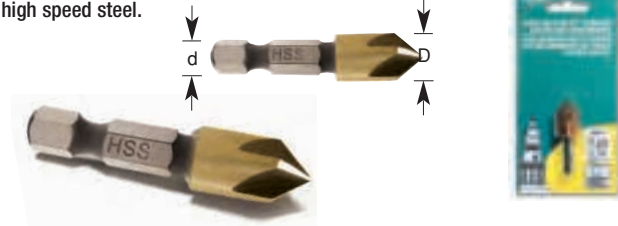

ØD	d	Tool No.
1/4"	1/4"	608-750
5/16"	1/4"	608-751
3/8"	1/4"	608-752
1/2"	1/4"	608-753
5/8"	1/4"	608-754
3/4"	1/4"	608-755

Unit Pack: Individually Carded

**SOCKET ADAPTERS**

ADAPTADOR PARA DADOS

**1/4" HEX SHANK**

Converts your drill into a power nut setter.



ØD	L	Tool No.
1/4"	2-3/8"	608-550
3/8"	2-3/8"	608-552
1/2"	2-3/8"	608-554

Unit Pack: Individually Carded

**SELF CENTERING DRILL BIT GUIDES**

GUIA AUTOCENTRADA CON BROCA PARA COLOCACION DE TORNILLO P/BISAGRA

**1/4" HEX SHANK**

Spring-loaded end for locating hinge screw holes. Includes HSS twist drill bit. Bright plated finish.



ØD	Replacement Drill Bit	Tool No.
5/64"	630-001	608-520
7/64"	630-098	608-522
9/64"	630-302	608-524
11/64"	630-302	608-526

Unit Pack: Individually Carded

**FACE FRAME COUNTERBORE**

SISTEMA CON PUNTA DE CARBURO PARA ENSAMBLE DE MARCOS (INCLUYE BROCA)

**1/4" HEX SHANK**

Carbide tipped with High Speed Steel (HSS) drill. Used for making "pocket holes".



ØD	ØD1	L	Description	Tool No.
3/8"	.136"	4"	Counter Bore #1	608-160
.136"	.136"	3"	#29 HSS Fishtail Drill Bit	608-162

Unit Pack: Plastic Hanging Tube



**CEILING TILE HANGER**

ADAPTADOR PARA TORNILLOS DE TECHOS SUSPENDIDOS

**1/4" HEX SHANK**

Unique tool for fastening special screws used in the installation of hanging ceiling grids.



ØD	Tool No.
1/4"	608-556
5/16"	608-558

Unit Pack: Individually Carded

**MAGNETIC BIT HOLDER**

ADAPTADOR RETRACTIL MAGNETICO PARA PUNTAS

**1/4" HEX SHANK**

Accommodates all 1/4" hex insert bits for all driver/drills.



L	Tool No.
2-1/4"	608-500
3"	608-502
4"	608-504

Unit Pack: Individually Carded

**MAGNETIC DRIVE GUIDE**

ADAPTADOR RETRACTIL MAGNETICO

**1/4" HEX SHANK**

Retracting screw holder for driving screws. 1/4" hex head fits all power driving bit tips. Carded.



L	Tool No.
80MM	608-510
120MM	608-512

Unit Pack: Individually Carded

**SPADE BITS WITH SPURS • 6" LONG**

BROCA PLANA PARA PERFORACION EN MADERAS



**1/4" HEX SHANK**

Precision ground and hardened steel spade bits for general purpose drilling of hard & softwood and wood by-products.

**NEW**  
ADDITIONAL SIZES



ØD	L	Tool No.
1/4"	6"	608-398
5/16"	6"	608-399
3/8"	6"	608-400
7/16"	6"	608-402
1/2"	6"	608-410
9/16"	6"	608-412
5/8"	6"	608-420
11/16"	6"	608-422
3/4"	6"	608-430
13/16"	6"	608-432
7/8"	6"	608-440
15/16"	6"	608-442
1"	6"	608-450
1-1/8"	6"	608-460
1-1/4"	6"	608-470
1-3/8"	6"	608-480
1-1/2"	6"	608-490

Unit Pack: Individual Vinyl Pouch

**SPADE BITS WITH SPURS • 16" LONG**  
**BROCA PLANA PARA PERFORACION EN MADERAS**



1/4" HEX SHANK

**NEW**

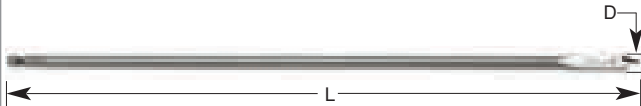

ØD	L	Tool No.
3/8"	16"	604-880
1/2"	16"	604-890
5/8"	16"	604-900
3/4"	16"	604-910
7/8"	16"	604-920
1"	16"	604-930

Unit Pack: Individual Vinyl Pouch

**TITANIUM COATED HSS DRILL SAW**  
**BROCA HSS CON RECUBRIMIENTO DE TITANIO**

**NEW**

High speed steel titanium coated all purpose drill saw. For use on wood and plywood 1/4" diameter hex head shank with 1-1/2" cut length. Handy for enlarging existing holes or cutting irregular shapes or contours.

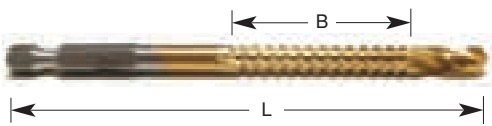

ØD	B	L	Tool No.
1/4"	1-1/2"	4-1/4"	608-102

Unit Pack: Individually Carded

**QUICK RELEASE EXTENSIONS**  
**EXTENSION PARA BROCA PLANA - CAMBIO RAPIDO**

1/4" HEX SHANK

**NEW**



ØD	L	Tool No.
1/4"	6"	604-932
1/4"	12"	604-934

Unit Pack: Individually Carded

**MAGNETIC NUT SETTERS**  
**ADAPTADOR MAGNÉTICO TUERCAS**

1/4" HEX SHANK

Universal 1/4" shank fits all drills and drivers. Used for power driving hex head screws, bolts and nuts.



ØD	L	Tool No.
1/4"	1-5/8"	608-560
1/4"	2-9/16"	608-562
5/16"	1-5/8"	608-564
5/16"	2-9/16"	608-566
3/8"	1-3/4"	608-568
3/8"	2-9/16"	608-570
7/16"	1-3/4"	608-572
7/16"	2-9/16"	608-574
1/2"	1-3/4"	608-576
1/2"	2-9/16"	608-578

Unit Pack: Individually Carded / Empaque Blister

**AUGER BITS**  
**BROCA PARA MADERA CON PUNTA ROSCADA**

1/4" HEX SHANK

Quality wood cutting auger bits for cutting with the quick release system.

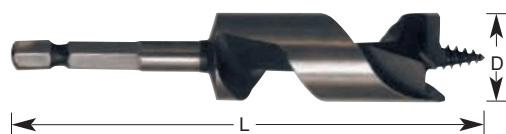

ØD	L	Tool No.
3/8"	4"	608-340
1/2"	4"	608-350
5/8"	4"	608-360
3/4"	4"	608-370
7/8"	4"	608-380
1"	4"	608-390

**MAGNETIC NUT SETTERS**  
**ADAPTADOR MAGNÉTICO PARA TUERCAS EMPAQUE A GRANEL**

1/4" HEX SHANK

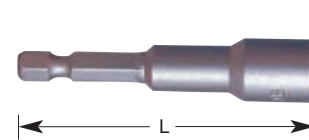

ØD	L	Pcs. Per Jar	Tool No.
1/4"	2-9/16"	50	608-563
5/16"	2-9/16"	50	608-567
3/8"	2-9/16"	50	608-571

Unit Pack: Bulk / Empaque Al Granel

**PHILLIPS SCREW BIT TIPS**  
PUNTA PHILLIPS

**NEW**  
ADDITIONAL SIZES

1/4" HEX SHANK



ØD Screw Size	L	Tool No.
#0	1"	608-600
#1	1"	608-602
#1	2"	608-630
#2	1"	608-604
#2	2"	608-632
#2	3"	608-605
#2	4"	608-608
#2	6"	608-609
#3	1"	608-606
#3	2"	608-634

Unit Pack: 5 pieces per card / Empaque Blister - 5pzs.

**PHILLIPS SCREW BIT TIPS**  
PUNTA PHILLIPS

**NEW**

1/4" HEX SHANK



ØD Screw Size	L	Tool No.
#2	1"	608-691
#2	2"	608-639

Unit: 25 pieces per bag with hanging card / Empaque Bolsita - 25pzs.

**PHILLIPS SCREW BIT TIPS**  
PUNTA PHILLIPS

**NEW**  
ADDITIONAL SIZES

1/4" HEX SHANK



ØD Screw Size	L	Pcs. Per Jar	Tool No.
#2	2"	150	608-633
#3	2"	150	608-637
#2	1"	250	608-690
#2	4"	100	608-635
#2	6"	50	608-636

Unit Pack: Bulk / Empaque Al Granel

**SLOTTED SCREW BIT TIPS**  
PUNTA PLANA

1/4" HEX SHANK



ØD Screw Size	L	Tool No.
#6	1"	608-610
#8	1"	608-612
#10	1"	608-614
#12	1"	608-616
#6	2"	608-640
#8	2"	608-642
#10	2"	608-644
#12	2"	608-646

Unit Pack: 5 pieces per card / Empaque Blister - 5pzs.

**DRYWALL BIT TIPS**  
PUNTA PARA TABLA DE YESO

**NEW**

1/4" HEX SHANK

Longer life with increased durability. Reinforced tip for longer life than a standard bit.

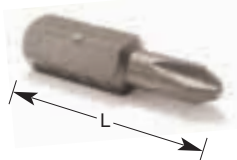

ØD Screw Size	L	Packed	Tool No.
#2	1"	5 pieces per card	608-800
#2	1"	Bulk packed 250 pcs.	608-801

Unit Pack: 5 pieces per card and bulk / Empaque Al Granel Y 5pzs.

**TITANIUM NITRIDE COATED DRYWALL BIT TIPS**  
PUNTA PARA TABLA DE YESO CON RECUBRIMIENTO DE TITANIO

**NEW**

1/4" HEX SHANK

Bits coated with titanium reduce slippage and adds more gripping power to protect the tip.

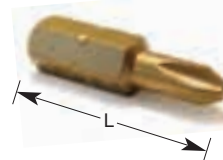

ØD Screw Size	L	Packed	Tool No.
#2	1"	5 pieces per card	608-802
#2	1"	Bulk packed 250 pcs.	608-803

Unit Pack: 5 pieces per card and bulk / Empaque Al Granel Y 5pzs.

**ADJUSTABLE DRYWALL SCREW SETTER**  
FIJADOR AJUSTABLE PARA TABLA DE YESO

**NEW**

**1/4" HEX SHANK**

Select the depth of your screw height where you want it in dry wall, plywood or particle board. Phillips #2 bit tip included.

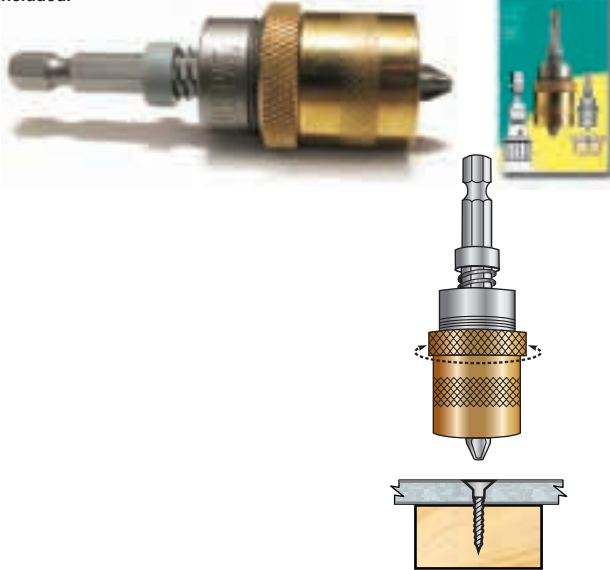

**Description**

Dry wall screw setter for #2 Phillips screws

**Tool No.**

**4019**

Unit Pack: Individually Carded

**DRYWALL SCREW SETTER**

FIJADOR DE TORNILLOS PARA TABLA DE YESO

**NEW**

**1/4" HEX SHANK**

Sets your #2 Phillips screw head at a depth just below the plane of your drywall, plywood or particle board.



**Description**

Economy dry wall screw setter for #2 Phillips screws

**Tool No.**

**4018**

Unit Pack: Individually Carded

**HEX BIT TIPS**  
PUNTA HEXAGONAL

**1/4" HEX SHANK**

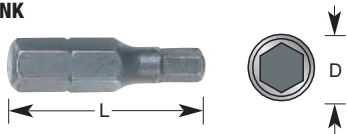

ØD	L	Tool No.
1/16"	1"	608-660
3/32"	1"	608-662
1/8"	1"	608-664

Unit Pack: 5 pieces per card / *Empaque Blister - 5pzs.*

**TORX® INSERT BITS**  
PUNTA TORX®

**NEW**

**1/4" HEX SHANK**

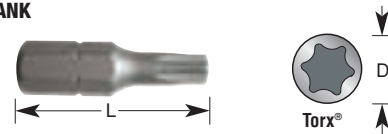

ØD Screw Size	L	Tool No.
T6	1"	608-700
T7	1"	608-701
T8	1"	608-702
T9	1"	608-703
T10	1"	608-704
T15	1"	608-705
T20	1"	608-706
T25	1"	608-707
T27	1"	608-708
T30	1"	608-709
T40	1"	608-710
T6	2"	608-711
T7	2"	608-712
T8	2"	608-713
T9	2"	608-714
T10	2"	608-715
T15	2"	608-716
T20	2"	608-717
T25	2"	608-718
T27	2"	608-719
T30	2"	608-720
T40	2"	608-721

Torx® is a registered trademark of Camcar Division of Textron, Inc.  
Unit Pack: 5 pieces per card / *Empaque Blister - 5pzs.*

**POZIDRIVE® INSERT BITS**  
PUNTA POZIDRIVE®

**NEW**

**1/4" HEX SHANK**

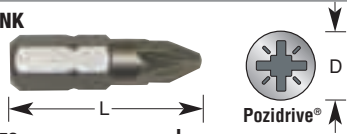

ØD Screw Size	L	Tool No.
#1	1"	608-670
#1	2"	608-671
#1	3"	608-672
#2	1"	608-673
#2	2"	608-674
#2	3"	608-675
#3	1"	608-676
#3	2"	608-677
#3	3"	608-678

Pozidrive® is a registered trademark of Camcar Division of Textron, Inc.  
Unit Pack: 5 pieces per card / *Empaque Blister - 5pzs.*

**SQUARE BIT TIPS**

PUNTA CUADRADA

1/4" HEX SHANK

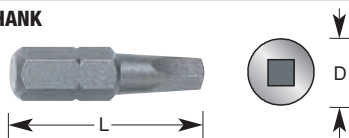

ØD Screw Size	L	Tool No.
#1	1"	608-620
#2	1"	608-622
#1	2"	608-650
#2	2"	608-652
#3	2"	608-654

Unit Pack: 5 pieces per card / *Empaque Blister - 5pzs.*

**SQUARE BIT TIPS**

PUNTA CUADRADA

1/4" HEX SHANK

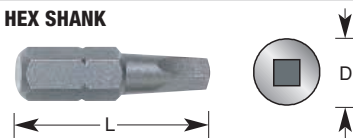

ØD Screw Size	L	Pcs. Per Jar	Tool No.
#2	2"	150	608-623

Unit Pack: Bulk / *Empaque Al Granel*

**BROKEN SCREW REMOVER**

EXTRACTOR DE TORNILLOS DAÑADOS

**NEW**

1/4" HEX SHANK

Designed to remove #6 to #14 screws with Phillips, Square or Slotted heads.

This tool allows you to drill out the damaged screw quickly, by inserting the bit into your drill. Firmly, hold the tip against the damaged screw head and reverse it out. The extremely sharp edges bite into the damaged screw head & work the screw out. Requires reversible drill.

*Not recommended for deck screws.*

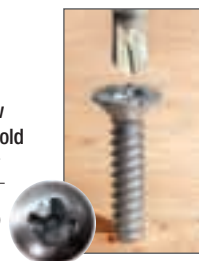

ØD Screw Size	Tool No.
#1 #6 - #8	608-731
#2 #8 - #10	608-732
#3 #10 - #14	608-733

3 Piece set (in a plastic case) includes one of each size.

Unit Pack: Individually Carded

**11 PC. DRILL & DRIVE COUNTERSINK SET**

JUEGO-11 PZS. AVELLANADORES C/BROCAS Y PUNTAS PARA DESTORNILLADORAS

This set includes 4 tool-steel countersinks designed for No. 6, 8,10, 12 screws and 3/32", 7/64", 1/8" and 9/64" drill bits.

Also included are 3 phillips screw tips (No. 0, 1, 2), 2 slotted screw tips and a quick release chuck\*.

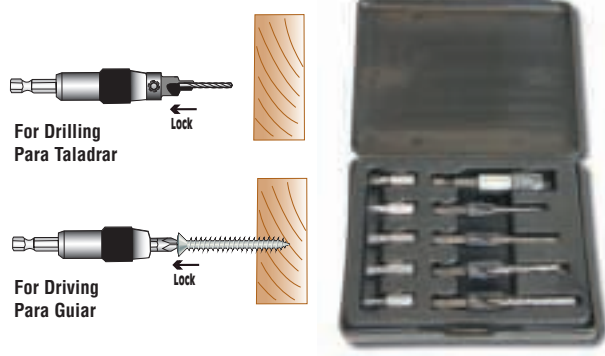

Description	Tool No.
11 piece set with case	608-530

Unit Packed: Clamshell

\*This quick release chuck is not sold separately - only as part of a set

**E-Z QUICK CHANGE BIT SET & CASE**

JUEGO-10 PZS. MANDRIL Y PUNTAS PARA DESTORNILLADOR

This craftsmans' clip-on case includes 9 of the most popular screw tips: phillips No. 0,1, 2; hex 1/16", 3/32", 1/8" slotted No. 6, 8, 10 and a quick release chuck\*.

Ideal for cabinet makers, contractors and DIY.

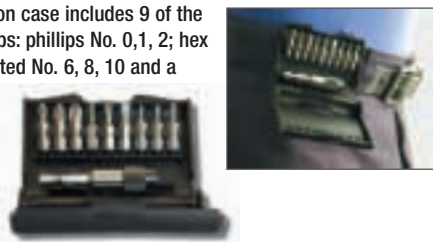

Description	Tool No.
11 piece set with case	608-532

Unit Pack: Individually Carded

\*This quick release chuck is not sold separately - only as part of a set

**5 PC. QUICK RELEASE COUNTERSINK SET**

JUEGO-5 PZS. AVELLANADOR CON BROCA CAMBIO RAPIDO

Use this item for fast, keyless tool changes. Set includes five individual 82° countersinks and 2" long twist drill bits for #4 through #12 wood screws. Hardened tool steel with black oxide finish. Made in U.S.A.



Description	Tool No.
5 piece includes 5/64", 3/32", 7/64", 1/8" & 9/64" drills	TDS-500

Unit Pack: Clamshell

### HINGE BORING (EUROPEAN) BROCA PARA BISAGRAS CON PUNTA DE CARBURO

57MM LONG • 10MM SHANK • 2 WING WITH SPURS  
CARBIDE TIPPED

For European style concealed hinges. Includes side cutting "spurs" for fast, clean boring. Economically priced.

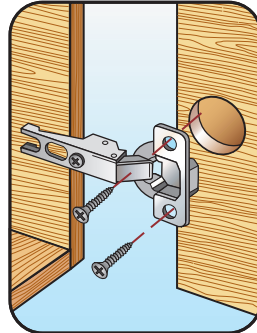
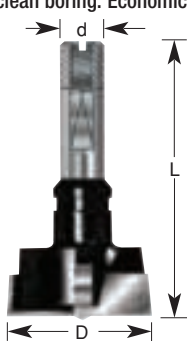

ØD	d	L	Tool No.
12mm	10mm	57mm	620-120
15mm	10mm	57mm	620-150
18mm	10mm	57mm	620-180
20mm	10mm	57mm	620-200
22mm	10mm	57mm	620-220
25mm	10mm	57mm	620-250
26mm	10mm	57mm	620-260
30mm	10mm	57mm	620-300
35mm	10mm	57mm	620-350

Unit Pack: Individually Carded

### FLAT BOTTOM COUNTERBORES AVELLANADOR DE FONDO PLANO

UP-SHEAR DESIGN • DRILL BITS INCLUDED • CARBIDE TIPPED

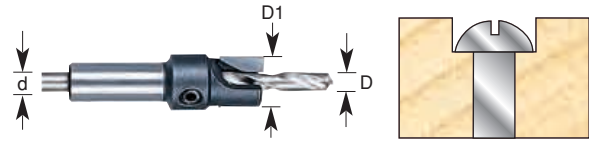

ØD Drill Dia.	Wood Screw Size	ØD1 Counterbore Dia.	Ød Shank	Tool No.
1/8" 3.2mm	4-6	3/8" 9.5mm	5/16" 8.0mm	630-100
5/32" 4.0mm	6-8	.394 10mm	5/16" 8.0mm	630-200
11/64" 4.4mm	8-9	.394 10mm	5/16" 8.0mm	630-300
3/16" 4.8mm	10	1/2" 12.7mm	3/8" 9.5mm	630-400
7/32" 5.6mm	12	1/2" 12.7mm	3/8" 9.5mm	630-500
15/64" 6.0mm	14	1/2" 12.7mm	3/8" 9.5mm	630-600
1/4" 6.3mm	16	1/2" 12.7mm	3/8" 9.5mm	630-700

Unit Pack: Individually Carded

Replacement Parts:

Tool No.	Replacement Drill Bit
630-100	630-102
630-200	630-202
630-300	630-302
630-400	630-402
630-500	630-502
630-600	630-602
630-700	630-702

NOTE: Replacement set screws (2 required per tool) Part No 67092.

### STRAIGHT WOOD PLUG CUTTERS CORTADOR PARA TAPAS DE MADERA

QUALITY WOOD CUTTERS FOR MAKING SMOOTH STRAIGHT PLUGS

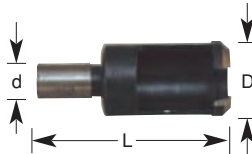

ØD	d	L	Tool No.
1/4"	3/8"	2"	607-100
3/8"	3/8"	2"	607-110
1/2"	3/8"	2"	607-120
5/8"	3/8"	2"	607-130

Unit Pack: Individually Carded

### 8 PC. WOOD PLUG CUTTER SET JUEGO — 8 PZS. CORTADOR DE TAPAS

STRAIGHT AND TAPERED



QUALITY WOOD CUTTERS FOR MAKING SMOOTH STRAIGHT PLUGS



QUALITY WOOD CUTTERS FOR MAKING SMOOTH TAPERED PLUGS



### TAPERED WOOD PLUG CUTTERS CORTADOR CONICO PARA TAPAS DE MADERA

QUALITY WOOD CUTTERS FOR MAKING SMOOTH TAPERED PLUGS

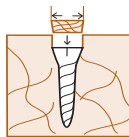
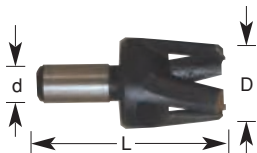

ØD	Ød	L	Tool No.
1/4"	3/8"	2"	607-300
3/8"	3/8"	2"	607-310
1/2"	3/8"	2"	607-320
5/8"	3/8"	2"	607-330

Unit Pack: Individually Carded

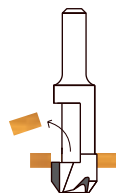

607-500  
8pc. set in wood box  
Includes both straight  
& tapered plug cutters



	L	Tool No.
8 pc. Set in Wood Box	Straight & Tapered	607-500

Set includes 1 of ea. straight & tapered plug cutter in the previous tables.

## CARBIDE TIPPED FORSTNER BITS BROCA FORSTNER EN CARBURO DE TUNGSTENO

Carbide tipped forstner bits were designed so the rim remains extremely sharp, especially at the leading edge.

It is here that the rim stays engaged in the cut so the bit won't drift laterally. This prevents tearout at the beginning of the cut to give a smooth clean cut. The finished hole will show a small center hole at the bottom of the hole. Clamshell packed for hanging display.

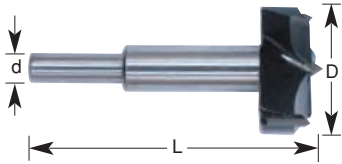

**660-500**  
14pc. Carbide Tipped Set



ØD	Ød	L	Tool No.
1/2"	3/8"	3-1/2"	<b>660-100</b>
5/8"	3/8"	3-1/2"	<b>660-110</b>
3/4"	3/8"	3-1/2"	<b>660-120</b>
7/8"	3/8"	3-1/2"	<b>660-130</b>
1"	3/8"	3-1/2"	<b>660-140</b>
1-1/8"	3/8"	3-1/2"	<b>660-150</b>
1-1/4"	3/8"	3-1/2"	<b>660-160</b>
1-3/8"	3/8"	3-1/2"	<b>660-165</b>
35mm	3/8"	3-1/2"	<b>660-170</b>
1-1/2"	3/8"	3-1/2"	<b>660-180</b>
1-5/8"	3/8"	3-1/2"	<b>660-190</b>
1-3/4"	3/8"	3-1/2"	<b>660-200</b>
1-7/8"	3/8"	3-1/2"	<b>660-210</b>
2"	3/8"	3-1/2"	<b>660-220</b>
2-1/8"	3/8"	3-1/2"	<b>660-230</b>
Wooden Box Only			<b>660-300</b>
14pc. Carbide Tipped Set			<b>660-500</b>

Unit Pack: Individually Carded

## FORSTNER BITS BROCA FORSTNER

Especially designed to drill flat holes in soft and hardwoods using portable or stationary equipment.

Forstner Bits are good at drilling severe angles and for partial angled holes. All off-angled and overlapping holes cut with a forstner bit should be drilled on a drill press.

Finished hole will show a small center hole at the bottom of the hole.



ØD	Ød	L	Tool No.
1/4"	5/16"	3-1/2"	<b>600-100</b>
3/8"	5/16"	3-1/2"	<b>600-110</b>
1/2"	5/16"	3-1/2"	<b>600-120</b>
5/8"	5/16"	3-1/2"	<b>600-130</b>
3/4"	3/8"	3-1/2"	<b>600-140</b>
7/8"	3/8"	3-1/2"	<b>600-150</b>
1"	3/8"	3-1/2"	<b>600-160</b>
1-1/8"	3/8"	3-1/2"	<b>600-170</b>
1-1/4"	3/8"	3-1/2"	<b>600-180</b>
1-3/8"	3/8"	3-1/2"	<b>600-190</b>
35mm	3/8"	3-1/2"	<b>600-200</b>
1-1/2"	3/8"	3-1/2"	<b>600-210</b>
1-5/8"	3/8"	3-1/2"	<b>600-220</b>
1-3/4"	3/8"	3-1/2"	<b>600-230</b>
1-7/8"	3/8"	3-1/2"	<b>600-240</b>
2"	3/8"	3-1/2"	<b>600-250</b>
2-1/8"	3/8"	3-1/2"	<b>600-260</b>
Wooden Box Only			<b>660-300</b>

Unit Pack: Individually Carded

## COIN SIZED FORSTNER BITS NEW BROCA FORSTNER MEDIDAS ESPECIALES PARA MONEDAS

### HSS FORSTNER BITS

These high speed steel forstner bits were designed for the precise cutting holes to show off prize coins. Each size has razor sharp spurs for perfect cuts. Due to expansion and contraction of wood, coins should be secured with double face tape.



**601-112**  
6pc. Carbide Tipped Set

ØD	Ød	Length	Size Coin	Tool No.
.764"	3/8"	4"	Penny	<b>601-100</b>
.849"	3/8"	4"	Nickle	<b>601-102</b>
.705"	3/8"	4"	Dime	<b>601-104</b>
.955"	3/8"	4"	Quarter	<b>601-106</b>
1.219"	3/8"	4"	Half Dollar	<b>601-108</b>
1.058"	3/8"	4"	Dollar	<b>601-110</b>
6pc. Set Includes All Sizes, Collar And Depth Control				<b>601-112</b>

## SAW TOOTH FORSTNER BIT SET BROCA DENTADA FORSTNER PARA MADERA

Heavy duty plastic case holds each forstner bit securely for storage and transporting to work sites. All the popular sizes in one convenient case.



**670-160**  
16pc. Hex Shank Set

Description	Tool No.
16 piece includes 1/4", 3/8", 1/2", 5/8", 3/4", 7/8", 1", 1-1/8", 1-1/4", 1-3/8", 1-1/2", 1-5/8", 1-3/4", 35MM, 2" & 2-1/8"	<b>670-160</b>

Unit Pack: Clamshell

**MORTISING CHISELS & BITS**  
**BROCA Y CINCEL PARA ESCOPLA**

**NEW**  
 ADDITIONAL SIZES

USED IN DRILL PRESS MORTISING ATTACHMENTS.

- Includes both square chisel & special drill bit

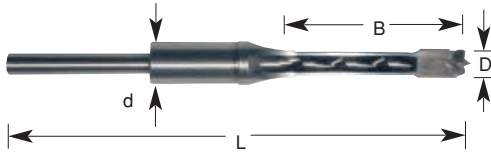

ØD	B	Ød	L	Tool No.
1/4"	1-7/8"	5/8"	8-1/4"	609-150
5/16"	2"	5/8"	8-1/4"	609-152
3/8"	3"	5/8"	8-1/4"	609-154
1/2"	3"	5/8"	8-1/4"	609-156
3/4"	3-5/8"	5/8"	8-1/4"	609-158
1/4"	1-3/4"	19MM(3/4")	8-1/4"	609-100
5/16"	1-3/4"	19MM(3/4")	8-1/4"	609-110
3/8"	2-7/8"	19MM(3/4")	8-1/4"	609-120
1/2"	2-7/8"	19MM(3/4")	8-1/4"	609-130
5/8"	2-7/8"	19MM(3/4")	8-1/4"	609-140

Unit Pack: Individually Boxed

**SPADE BITS WITH SPURS**  
**BROCA PLANA PARA PERFORACIONES EN MADERAS**

**NEW**  
 ADDITIONAL SIZES

1/4" SHANK • 6" AND 16" LONG

Precision ground and hardened steel spade bits for general purpose drilling of hard and softwoods and wood by-products. Great for plumbing and electrical contractors.



6" LONG		16" LONG	
ØD	Tool No.	ØD	Tool No.
1/4"	604-100	1/4"	604-810
5/16"	604-150	5/16"	604-815
3/8"	604-200	3/8"	604-820
7/16"	604-240	1/2"	604-830
1/2"	604-250	5/8"	604-840
5/8"	604-270	3/4"	604-850
9/16"	604-300	7/8"	604-860
11/16"	604-350	1"	604-870
3/4"	604-400		
13/16"	604-450		
7/8"	604-500		
15/16"	604-550		
1"	604-600		
26mm	604-610		
1-1/16"	604-620		
1-1/8"	604-650		
1-3/16"	604-680		
1-1/4"	604-700		
1-3/8"	604-730		
35mm	604-740		
1-1/2"	604-750		



Unit Pack: Individually Carded  
 Also available in quick release see page 48 and 49.

**AUGER BITS**  
**BROCA PARA MADERA PARA USO EN TALADRO ELECTRICO**

Auger bits require little feed pressure because the threaded lead screw will put the bit into the cut. For deep holes the auger clears its chips well and the screw point prevents the bit from wandering. Great for plumbing and electrical contractors. Packaged in vinyl pouches.

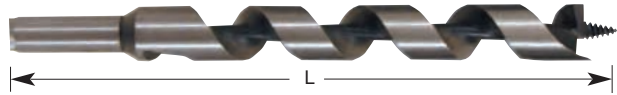

9" LONG		18" LONG	
ØD	Tool No.	ØD	Tool No.
1/4"	605-100	3/8"	605-500
5/16"	605-110	1/2"	605-510
3/8"	605-120	9/16"	605-520
7/16"	605-130	5/8"	605-530
1/2"	605-140	11/16"	605-540
9/16"	605-150	3/4"	605-550
5/8"	605-160	13/16"	605-560
11/16"	605-170	7/8"	605-570
3/4"	605-180	15/16"	605-580
13/16"	605-190	1"	605-590
7/8"	605-200	1-1/8"	605-600
15/16"	605-210	1-1/4"	605-610
1"	605-220	1-3/8"	605-620
1-1/8"	605-230		
1-1/4"	605-240		
1-3/8"	605-250		

Unit Pack: Individual Vinyl Pouch  
 Also available in quick release see page 49.

**6 PIECE SPADE BIT SET**  
**JUEGO-6 PZS.-BROCAS PLANAS DE PRECISION PARA MADERA**



Description	Tool No.
6 piece spade bit set includes 3/8", 1/2", 5/8", 3/4", 7/8" & 1"	604-800

Unit Pack: Individual Vinyl Pouch

**SPADE BIT EXTENSIONS**  
**EXTENSION PARA BROCAS PLANAS**



Description	Tool No.
6" spade bit extension, 1/4" shank	604-760
12" spade bit extension, 1/4" shank	604-770

Unit Pack: Individual Vinyl Pouch



## LOCKSET INSTALLATION KITS JUEGO 3 PZS PARA INSTALACION DE CERRADURAS

Includes 2-1/8" hole saw with 3/8" shank arbor and either 7/8" or 1" spade bit. For installation of 2-1/8" locksets. Instructions included.

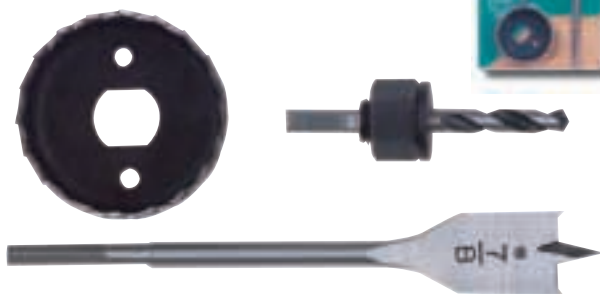

Description	Tool No.
3 piece kit with 7/8" spade bit	650-100
3 piece kit with 1" spade bit	650-200

Unit Pack: Individually Carded

## THE WORKHORSE BROCA PARA MADERA CON AUTO-ALIMENTACION

**NEW**

**DESIGNED FOR PLUMBERS AND ELECTRICIANS**

Self feeding boring bits for plumbing and electrical contractors. Heat treated special steel alloy for maximum wear resistance with a replaceable feed screw that easily pull the bit through the material. Drills large diameter holes in wood for piping and conduit. Each bit includes allen wrench and extra feed screw.



ØD	Rigid Conduit	Tubing	L	Repl. Screw	Tool No.
1"	1/2"	1/2"-3/4"	4-1/2"	500-20	600-350
1-1/8"	1/2"	1"	4-1/2"	500-20	600-352
1-1/4"	3/4"	1-1/8"	4-1/2"	500-20	600-354
1-3/8"	1-1/2"	1-1/4"	4-1/2"	500-20	600-356
1-3/4"	1-1/4"	1-1/2"	4-1/2"	500-20	600-360
2"	1-1/2"	1-7/8"	4-1/2"	500-20	600-362
2-9/16"	2"	2-1/2"	4-1/2"	500-20	600-368
3"	2-1/2"	2-7/8"	5-3/4"	500-22	600-370
3-5/8"	3"	3-1/2"	5-3/4"	500-22	600-372
5 piece set includes 1", 1-1/8", 2", 2-9/16", 3-5/8"					600-376
Wrench					500-40

Unit Pack: Individually Carded

## BEVEL EDGE WOOD CHISEL SET JUEGO DE FORMONES

The bevel edge chisel sets are made of high carbon tool-steel and treated with black-oxide to prevent rust. Each chisel tip is hardened, tempered, ground and honed to a precision finish. Handles are made of high impact, polypropylene plastic. Overall length: 8"



No. 3370  
Free oil Stone Sharpener  
with 8-Piece Set



No. 3380

Description	Tool No.
3 Piece Set, includes 1/2", 3/4", 1" (clamshell packed)	3380
8 Piece Set, includes 1/8", 1/4", 3/8", 1/2", 5/8", 3/4", 1" (each plastic case)	3370

Made in Sheffield, England

## CORNER CHISEL CORTADOR PARA BISAGRAS

**NEW**

Easily cuts 90° corners for fitting hinges. Simply line the straight edges of the cut & strike the edge with a hammer. It turns your rounded corner into a neat square corner. Precision ground high speed steel.



Description	Tool No.
1 Corner Chisel	3420

Unit Pack: Individually Carded

## CARPENTER PENCILS LAPICES DE CARPINTEROS

Blister packed for hang-up display. Each package contains 6 pencils.



Description	Tool No.
6 Pencils	AL-200

Unit Pack: Individually Carded