

Fitting for top-running wooden doors up to 120 kg (264 lbs.), with surface mounted running track or running track flush with the ceiling. Optionally with soft and self closing mechanism. Wall or ceiling mounting. Minimal installation height.

Product highlights

- Aesthetics** Low installation height – only minimal gap between door and running track
- Productivity** Interlocking of the suspension at the front edge is possible

Technical specifications

- Max. 120 kg (264 lbs.)
- Max. 4000 mm (13'1 15/32")
- Max. 3000 mm (9'10 1/8")
- 35–80 mm (1 3/8" to 3 5/32")

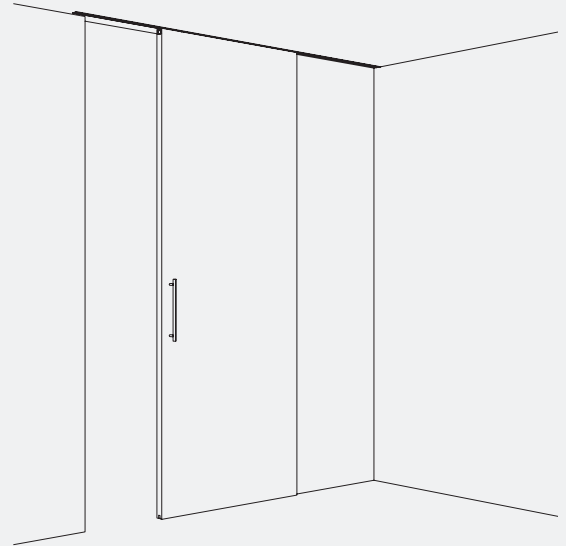



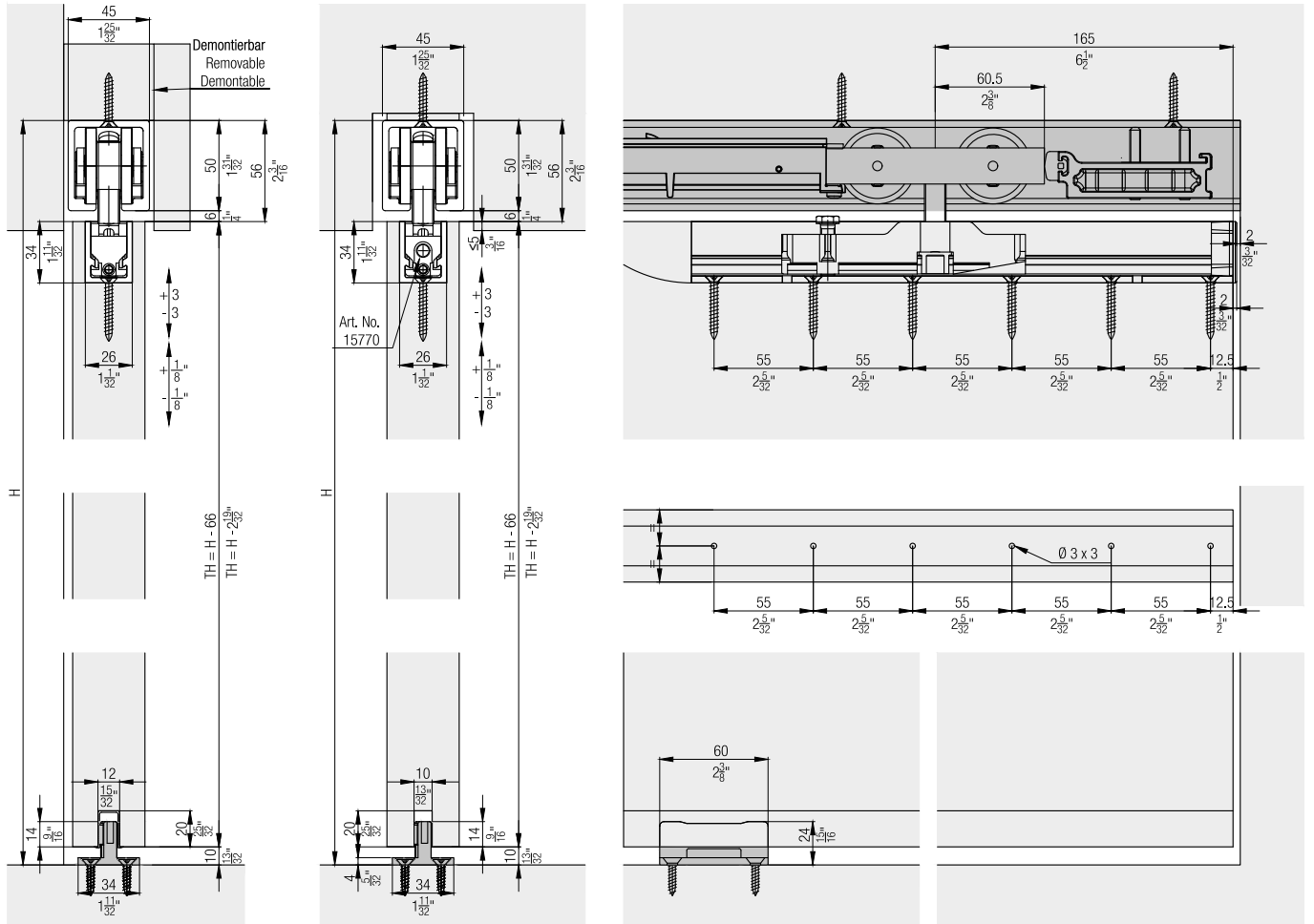



Installation examples

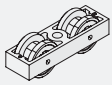

Set for 1 wooden door up to 120 kg (264 lbs.)

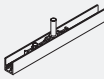
	No.
Hawa Junior 120 B, for 1 door	25908
Hawa Junior 120 B, with 2 track stoppers, for 1 door	26042

Set consisting of:

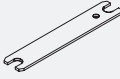
		25908	26042	No.
	Two-wheeled running gear, M12, plastic wheels	2	2	25900
	Track stopper, with adjustable retention spring	1	2	14858
	Suspension profile, with plate M12	2	2	14934
	Cover cap for glass suspension profile, plastic, anthracite	2	2	20907
	Bottom guide, zero tolerance, groove width 10 mm (13/32"), plastic black	1	1	14427
	Screw-on rubber door stop	1	1	10629
	Suspension assembly locking wrench	1	1	14861

Running tracks

		mm (inch)	No.
	Running track, aluminum, anodized, pre-drilled	2,500 (8' 2 7/16")	14866
		3,000 (9' 10 1/8 ")	14867
		4,000 (13' 1 15/32")	14868
		6,000 (19' 8 7/32")	14869
		cut to size	14871

Guide tracks

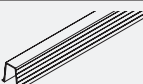
		mm (inch)	No.
	Guide track, for groove mounting, plastic, 10-piece set	1,300 (4' 3 3/16")	14540



Soft close SoftMove 120
For soft closing in opening and closing direction order 2 sets.

		No.
	Soft close SoftMove 120	25988

Angled profiles for wall mounting



		mm (inch)	No.
	Angled profile for wall mounting, aluminum, anodized, pre-drilled	4,000 (13' 1 15/32")	25327
		6,000 (19' 8 7/32")	25328
		cut to size	25329

Individual components to angled profile

		No.
	Set for wall mounting, track length up to 2000 mm (6' 6 3/4 "), 10-piece set	19041
	Cover cap to angled profile, metal, chrome-plated, matt, suitable to both sides	25335
	Connecting pins to profiles, 2-piece set	21347



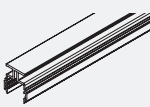
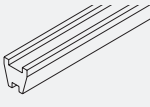

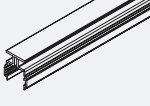
Hawa Adapto 120 concrete casting system, without fixed glazing

	No.
Inset profile for concrete surfaces Hawa Adapto 120, without fixed glass, 3000 mm (9'10 1/8")	20218
Inset profile for concrete surfaces Hawa Adapto 120, without fixed glass, 4000 mm (13'1 15/32")	20219





Set consisting of:		mm (inch)	20218	20219	No.
	Inset profile for concrete surfaces, without fixed glass, aluminum	3,000 (9' 10 1/8 ")	1		20093
	Polystyrene insert, 1000 mm (3'3 1/4 "), without fixed glass	1,000 (3' 3 3/8 ")	3	4	19419
	Assembly clips, without fixed glass plastic, black		4	5	19346
	Cover cap, without fixed glass, plastic, gray		2	2	19368
	Inset profile for concrete surfaces, without fixed glass, aluminum	4,000 (13' 1 15/32")		1	20091

Assembly set for Hawa Adapto 120

	No.
Assembly set, with countersunk head screw, length up to 2500 mm (8'2 7/16")(8'2 7/16")	22841
Assembly set, with countersunk head screw, length 2501–4000 mm (8'2 15/32"–13'1 15/32")	22842
Assembly set, with countersunk head screw, length 4001–6000 mm (13'1 17/32"– 19'8 7/32")	22843

Set consisting of:		22841	22842	22843	No.
	Distance plate, plastic, 1 mm (1/32")	2	2	3	19398
	Distance plate, plastic, 2 mm (3/32")	2	2	3	19399
	Distance plate, plastic, 3 mm (1/8")	2	2	3	19400
	Distance plate, plastic, 5 mm (3/16")	4	4	6	19401
	Countersunk screws, 6x20 mm (1/4"x25/32"), 10-piece set	1	2	3	22844

Accessories

	No.	
	Cover cap, chrome-plated, matt, suitable to both sides	25332
	Bottom door stopper, with centering, stainless steel look	21473
	Bottom door stopper, with centering, chrome-plated, matt	20773
	Hawa assembly wegde, for 1 door	15770
	Bottom guide, rattle proof, groove width 10 mm (13/32"), plastic, black, 10-piece set	25958

Hawa Junior 120 angled profile for wall mounting

The intelligent wall mounting with the new angled profile for Hawa Junior running tracks for a door weight of up to 120 kg (264 lbs.).

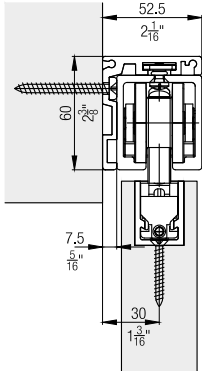

Hawa Adapto 120 concrete casting system

The Hawa Adapto 120 concrete casting system can be easily and efficiently integrated into the building shell and allows Hawa Junior 120 running tracks to be installed flush with the ceiling.

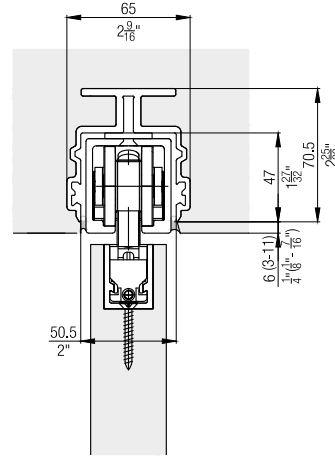

Hawa Confort 120

The convenient solution to an old problem. Inadequate fastening options in brittle sub-floors or in the area of floor heating. This bottom guide is mounted on the wall.

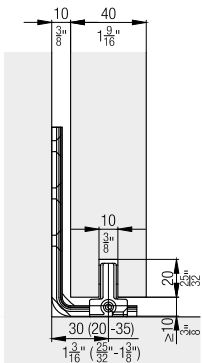

Mounting wedge

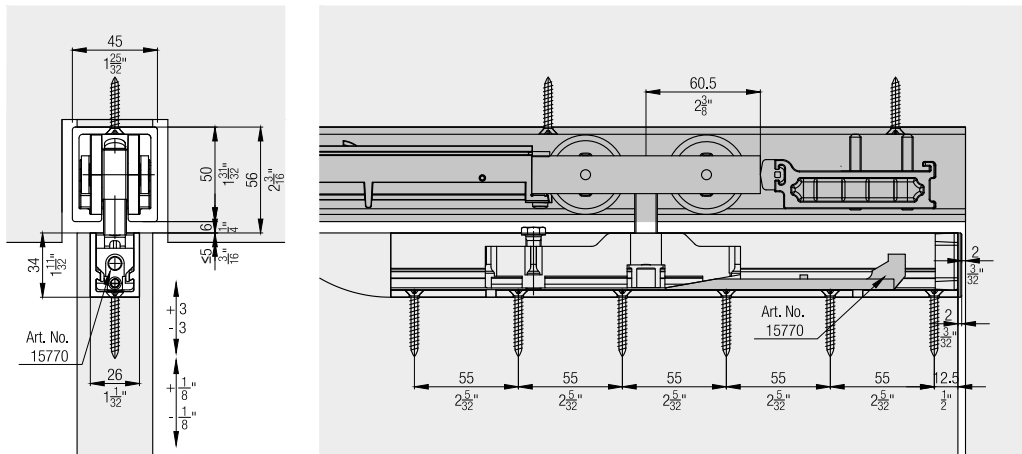

SoftMove 120 soft closing mechanism

Completely integrated into the running track, the SoftMove decelerates sliding doors and draws them into their final position.

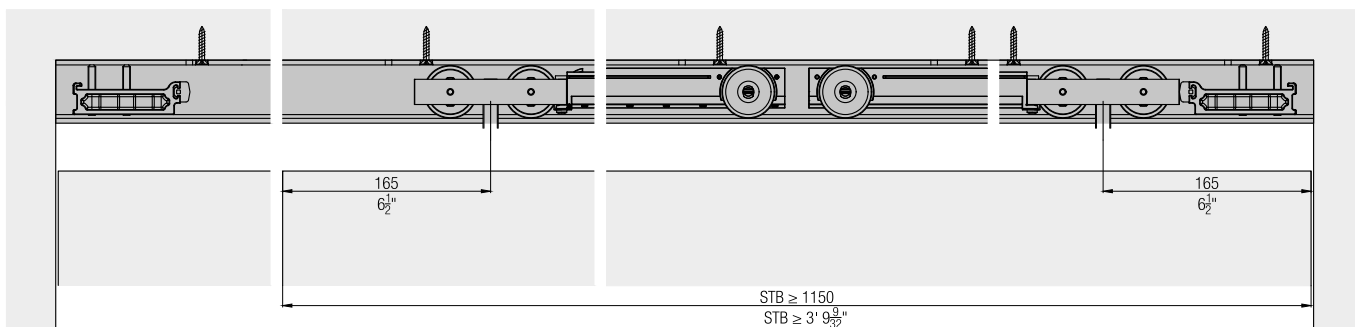
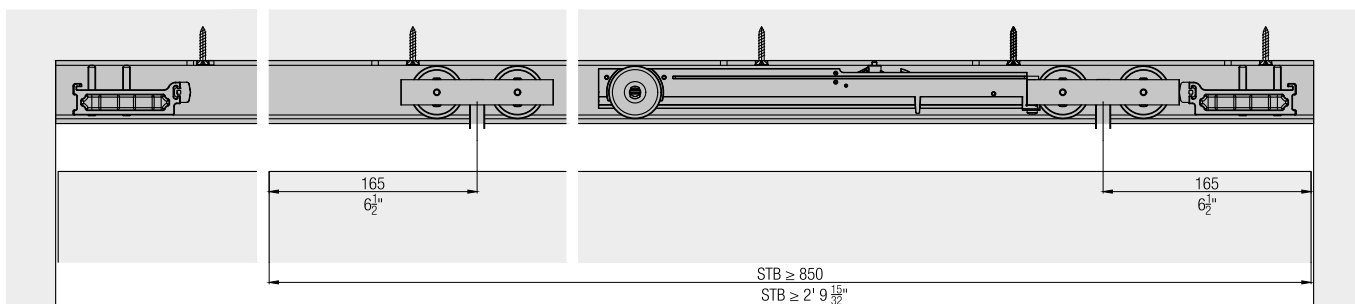

Accessories

- Hawa Junior bottom guides for wall mounting from page 508
- Lock solutions from page 511
- General accessories from page 518

Planning/execution

Further information about the product can be found on www.hawa.com.