

**Measurements:**

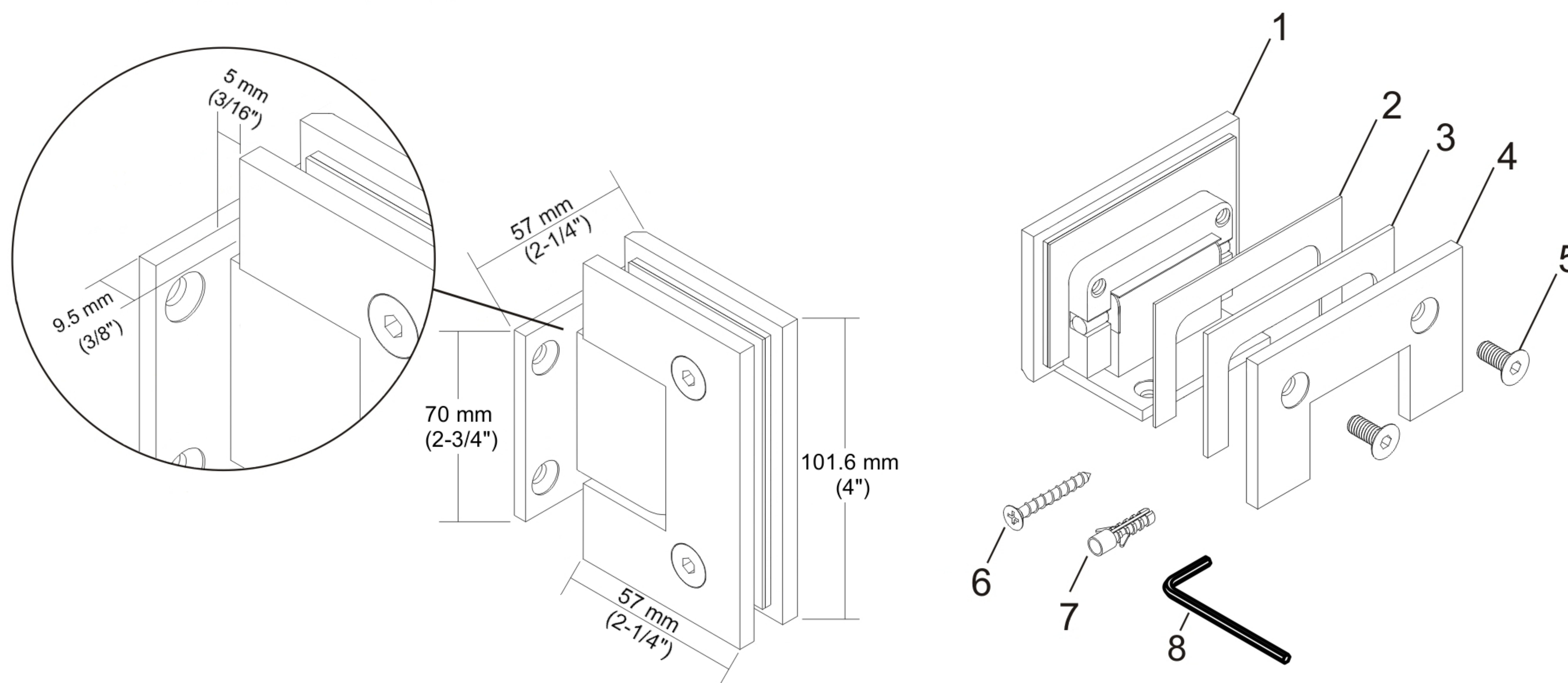

\*See online for available finishes  
 \*For 10-12 mm (3/8"-1/2") glass

**Components for 1 hinge:**

SN	Name	Qty
1	Hinge	1
2	1 mm gasket (1/32")	2
3	2 mm gasket (3/32")	2
4	Hinge plate	1
5	Screws M6x16 mm (5/8")	2
6	Self-tapping screw	4
7	Plastic wall anchor	4
8	Allen key	1

- ▶ **10 mm (3/8") glass:**  
2 mm (3/32") gasket
- ▶ **12 mm (1/2") glass:**  
1 mm (1/32") gasket
- ▶ **Capacity for 2 hinges:**  
Weight: 45 kg (99 lb)  
Door width: 762 mm (30")
- ▶ **Capacity for 3 hinges:**  
Weight: 68 kg (150 lb)  
Door width: 915 mm (36")

**Glass template:**

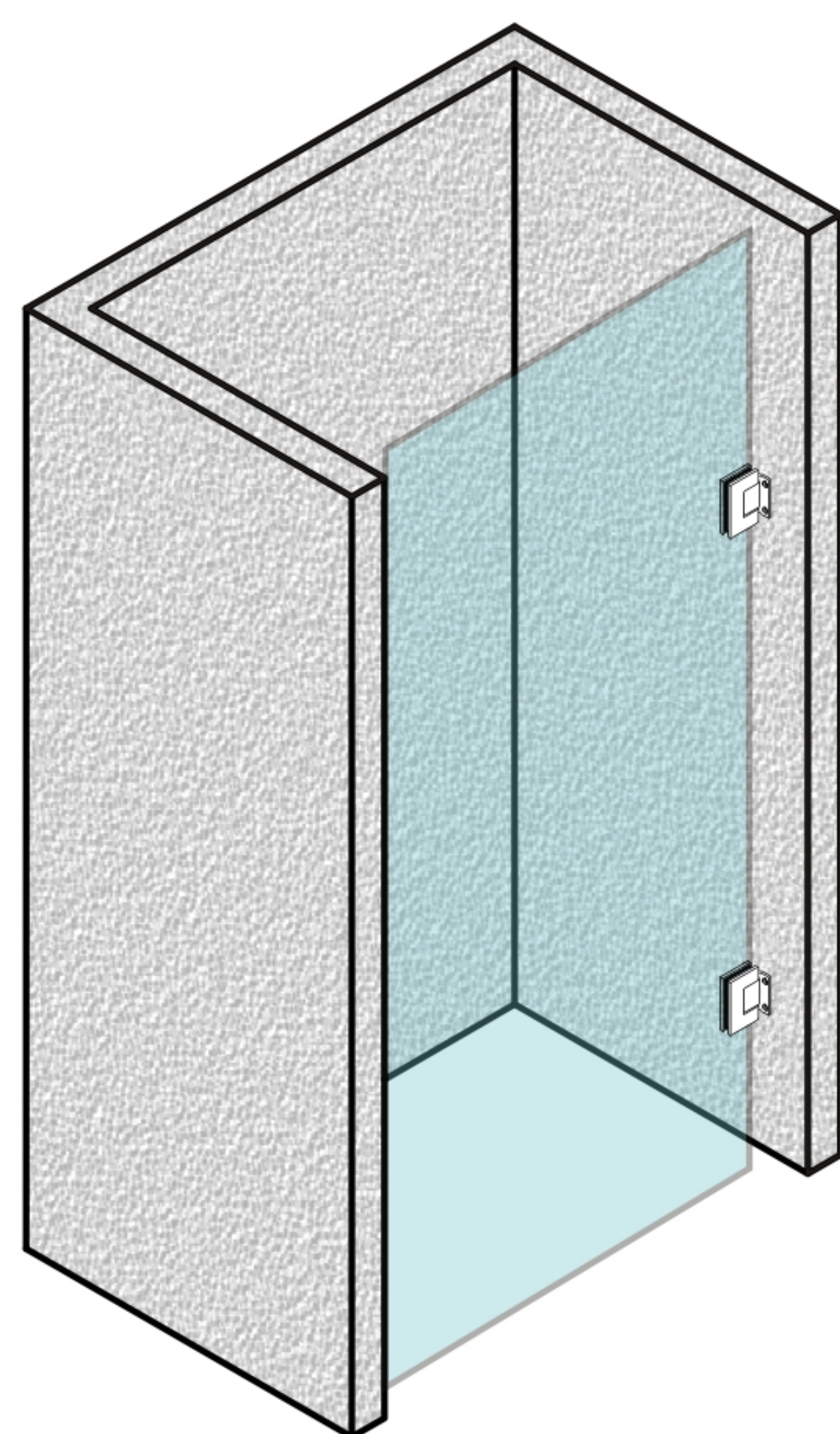

**Standard Template**

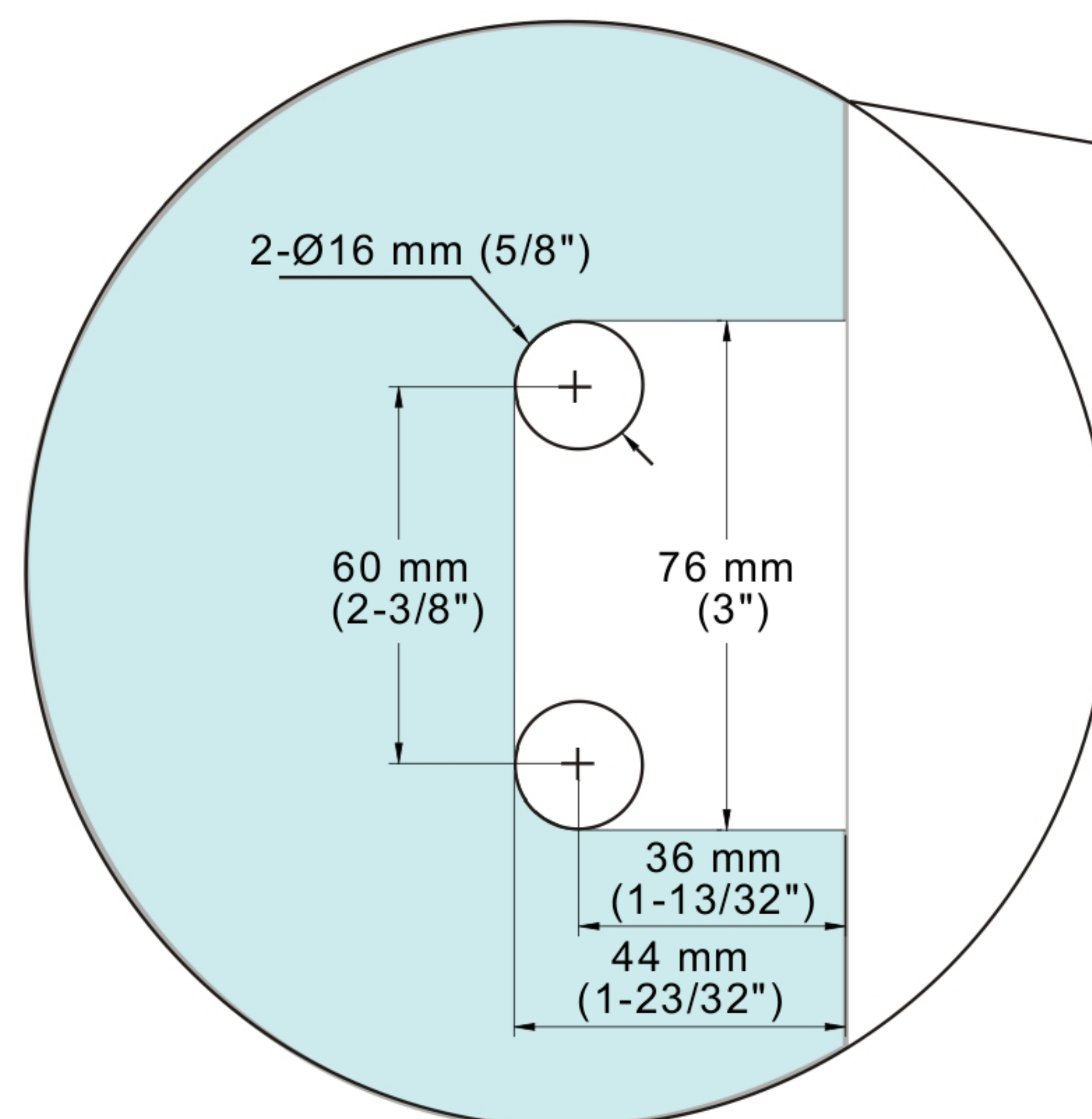

**Clearance Template**

