

**Hinges with integrated soft-close mechanism in the hinge cup.**

**Bright nickel plated steel cup and arm. Dimensions of the Ø 35 mm cup.**

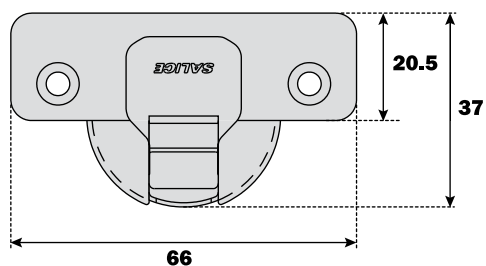

Constant "L" value of 0.7 mm (it does not change during side adjustment).

Approx. number of hinges required according to the door dimension and weight.

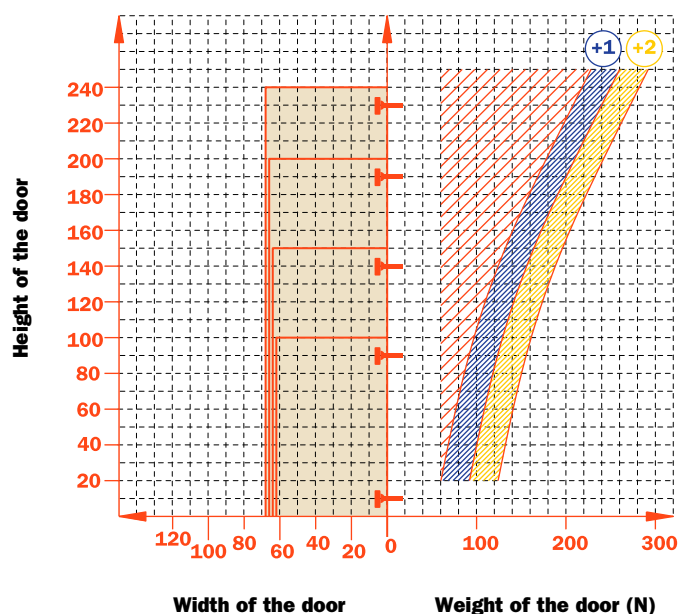

**Adjustments**

Compensated side adjustment from -1.5 mm to +4.5 mm.  
 Height adjustment  $\pm 2$  mm.  
 Depth adjustment with Series 200 mounting plates +2.8 mm.  
 Depth adjustment with Domi snap-on mounting plates from -0.5 mm to +2.8 mm.  
 Anti-sliding safety stop.

**Mounting plates**

Symmetrical and asymmetrical bright nickel plated steel or die-cast Series 200 mounting plates.  
 Snap-on assembly on Domi mounting plates.  
 Positioning with pre-determined stop on traditional Series 200 mounting plates.

N.B. : Use POZIDRIVE No. 2 screwdrivers for all screws.

Wood screw		A	A	P	P	U	U
Rapido		6	6	7	7	2	2
Dowel		B	B	R	R	W	W
Logica		I	I	J	J	Q	Q

Use this table to identify the available drillings and fixings.

Fill the third position of the hinge code number with the letter or the number corresponding to your choice. I.e.: C7\_6AD9.

↑  
Fill this position with the chosen letter or number.

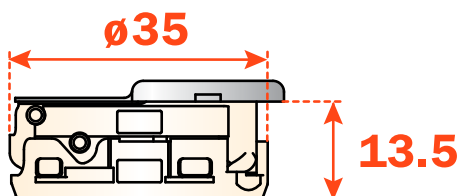

**110°, 155° opening  
and complementary hinges**



**Attention:**  
it is essential to drill the door as specified for the  
perfect functioning of the hinge.



**Technical information**

**Hinges with integrated soft-close mechanism in the hinge cup.**

**Hinges for min. 16 mm thick doors.  
13.5 mm deep cup.**

110° opening.  
Possible drilling distance on the door (K): from 3 to 6 mm.  
Compatible with all traditional Series 200 mounting plates and with all Domi snap-on mounting plates.

**Space needed to open the door**

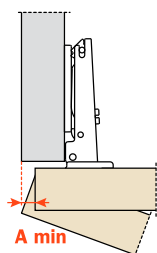

	T=	16	17	18	19	20	21	22	23	24	25	26
K=3	<b>A=</b>	0.7	0.9	1.1	1.3	1.6	1.9	2.2	2.6	3.2	4.4	5.7
K=4	<b>A=</b>	0.6	0.8	1.1	1.3	1.6	1.8	2.2	2.5	2.9	3.4	4.7
K=5	<b>A=</b>	0.6	0.8	1.0	1.3	1.5	1.8	2.1	2.4	2.8	3.2	3.7
K=6	<b>A=</b>	0.6	0.8	1.0	1.2	1.5	1.8	2.1	2.4	2.7	3.1	3.6

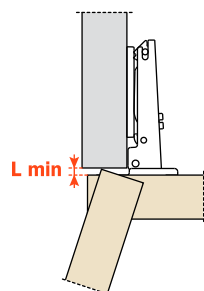

	T=	16	17	18	19	20	21	22	23	24	25	26
K=3	<b>L=</b>	0.0	0.0	0.0	0.0	0.0	0.0	0.0	0.2	0.4	0.6	0.9
K=4	<b>L=</b>	0.0	0.0	0.0	0.3	0.5	0.7	0.9	1.1	1.4	1.6	1.8
K=5	<b>L=</b>	0.6	0.8	1.0	1.2	1.5	1.7	1.9	2.1	2.4	2.6	2.8
K=6	<b>L=</b>	1.5	1.8	2.0	2.2	2.4	2.7	2.9	3.1	3.3	3.6	3.8

**The above values are calculated on the assumption that the doors have square edges. They are reduced if the doors have radiussed edges.**

**Projection of the door**

Projection of the door from the cabinet side at the max. opening. The figures are based on a straight arm hinge, H=0 mm thickness of mounting plate and K value = 3 mm.

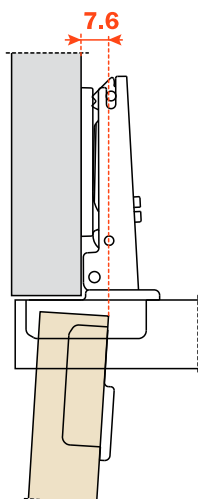

**“C” value**

With this formula you can obtain the max. thickness of the moulded door that can be opened without touching adjacent carcass sides, doors or walls, whilst bearing in mind the above L-K-T values.

$$C = 22.5 + K + A$$

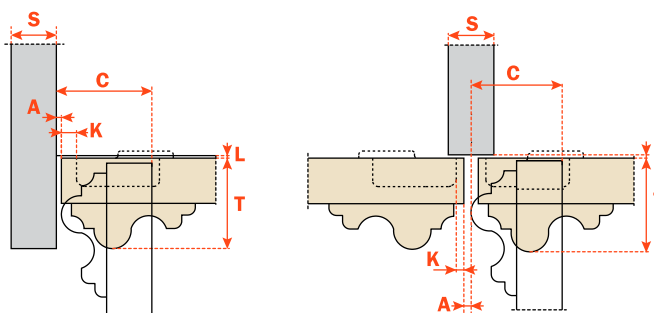

Use these formulas to determine the type of hinge arm, the drilling distance "K" and the height of the mounting plate "H" which is necessary to solve each application problem.

Use the tables "Drillings and fixings" at page 33 to complete the code number of the desired hinge.

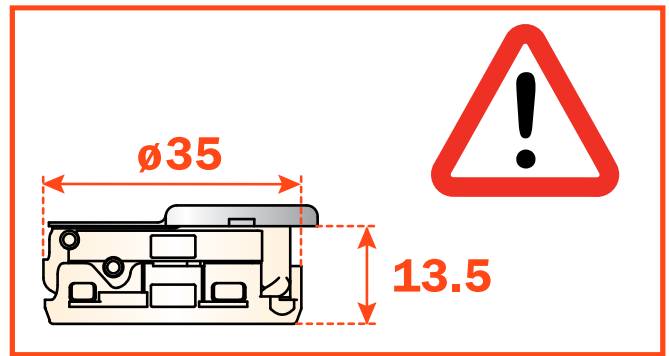

Arm 0

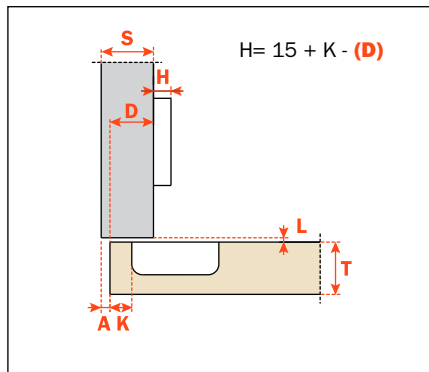

**H110C7R6AE9**

Dowel 

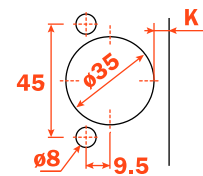

Arm 5

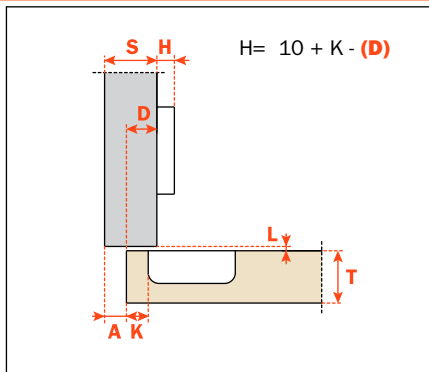

**H110C7R6DD9**

Dowel 

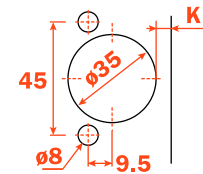

Arm 9

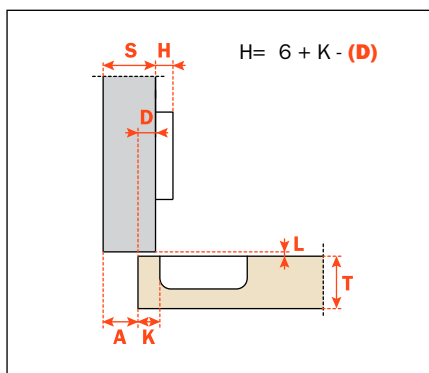

**H110C7R6GD9**

Dowel 

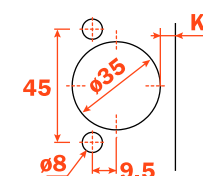

Arm 17

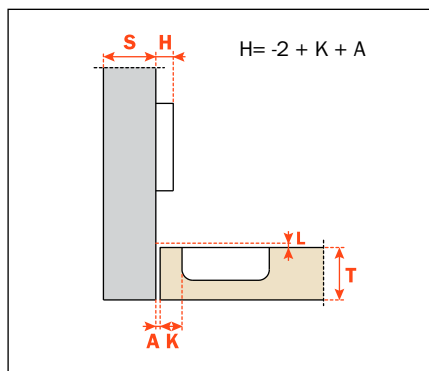

**H110C7R6PD9**

Dowel 

