

Sizes in millimeters  
Dimensions en millimètres

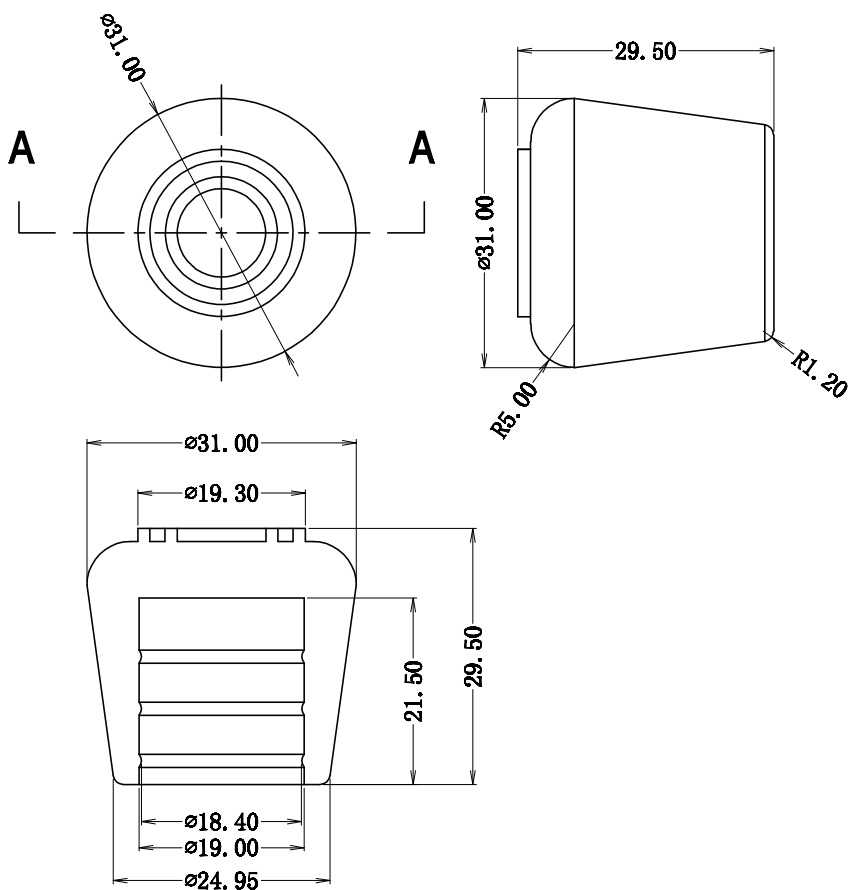

REFERENCE: F45376

