

Sizes in millimeters
Dimensions en millimètres

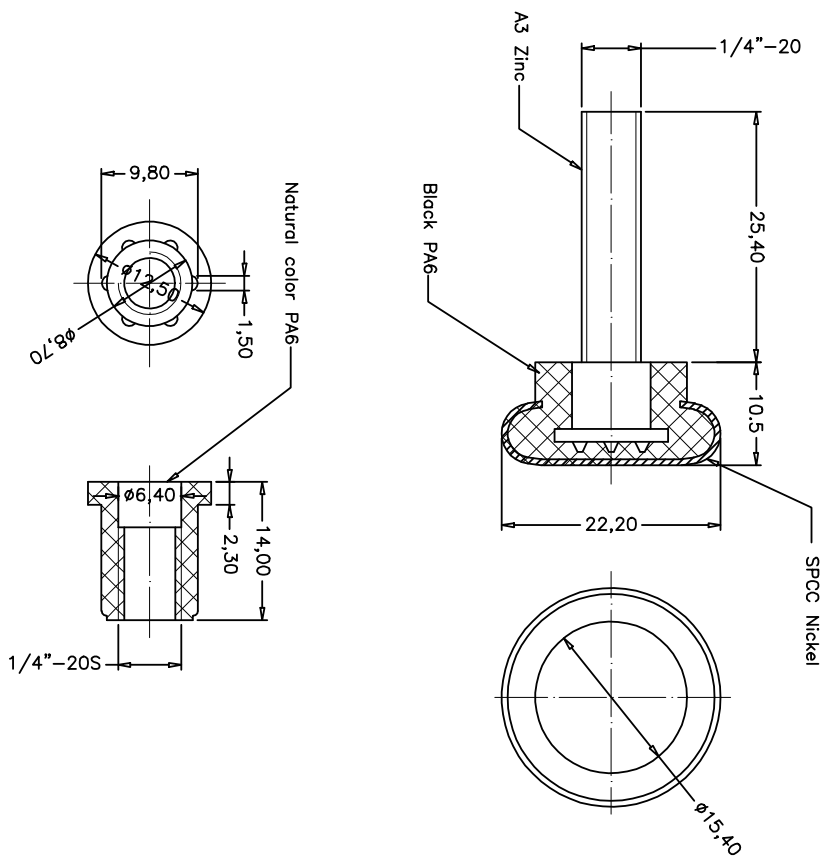

REFERENCE: F32024, F43891

