

Sizes in millimeters
Dimensions en millimètres

I.D. = inside dimension
O.D. = outside dimension
D.I. = dimension intérieure
D.E. = dimension extérieure

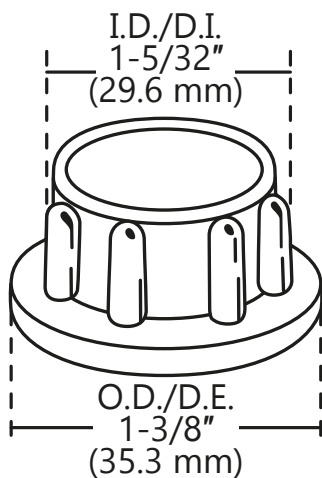

REFERENCE: F22947, V22947

