

Installation steps:

Tools

Tools required for the installation.

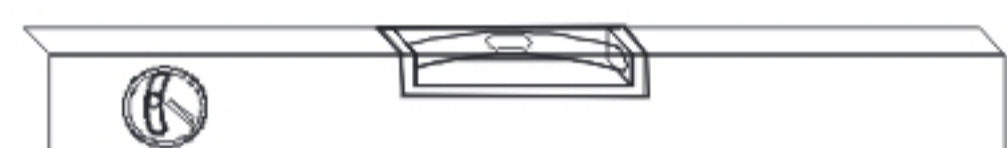

Level

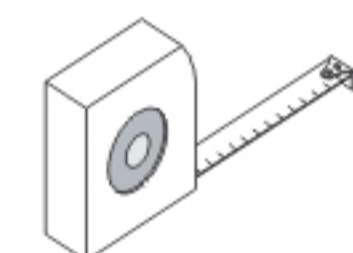

Tape Measure



Power Drill



Pencil

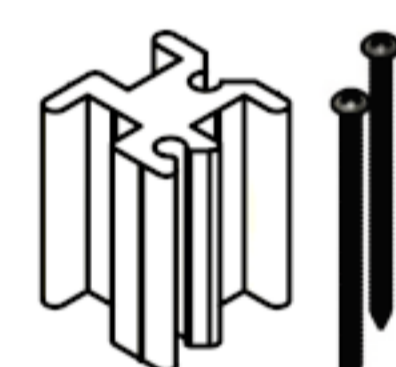

Base with screws
(Sold separately)

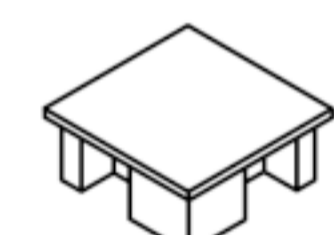

Cover Cap
(Sold separately)



Super Glue

①

Cut the posts to the desired length and use the diagram below to plan the spacing of your partition posts. Note: Glass deduction is 7/16" on each side of the infill.

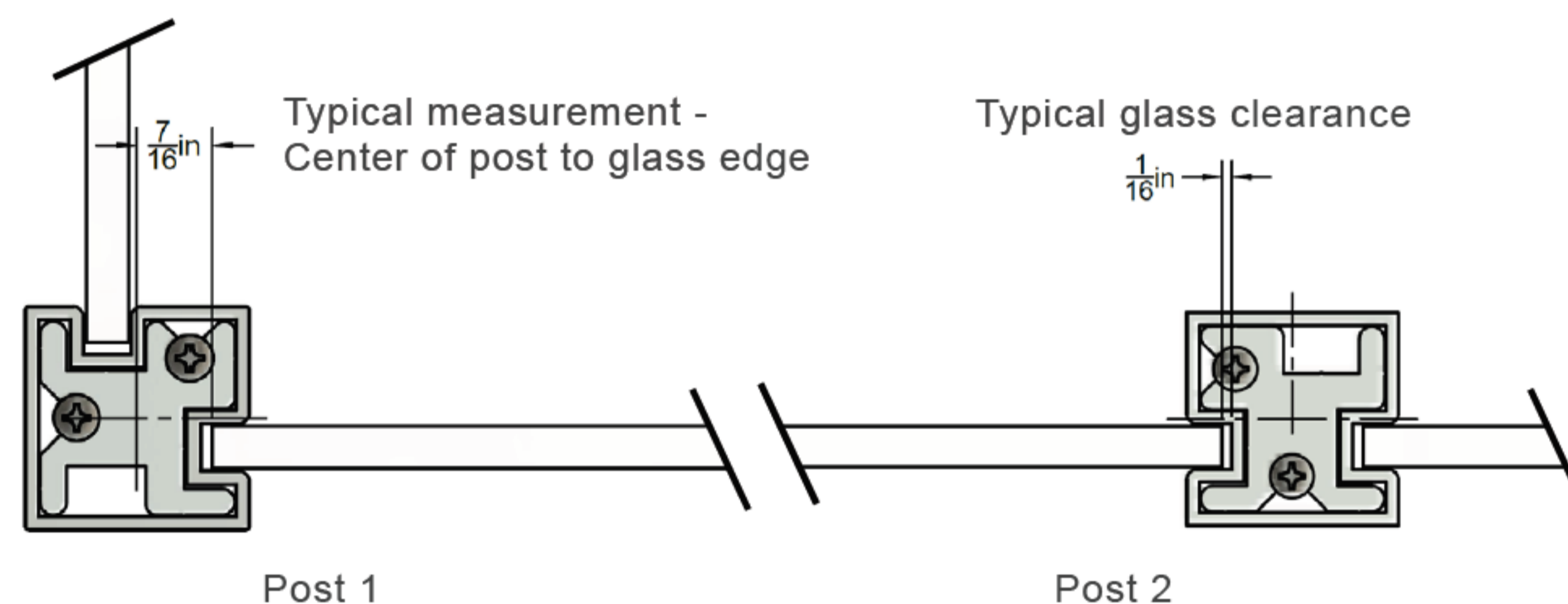

②

Use the screw holes in the base as a guide to drill the pilot holes then drive the screws into place.

NOTE: Drill Bit Size Recommendation:
 1/8" for hardwood substrate
 7/64" for softwood substrate

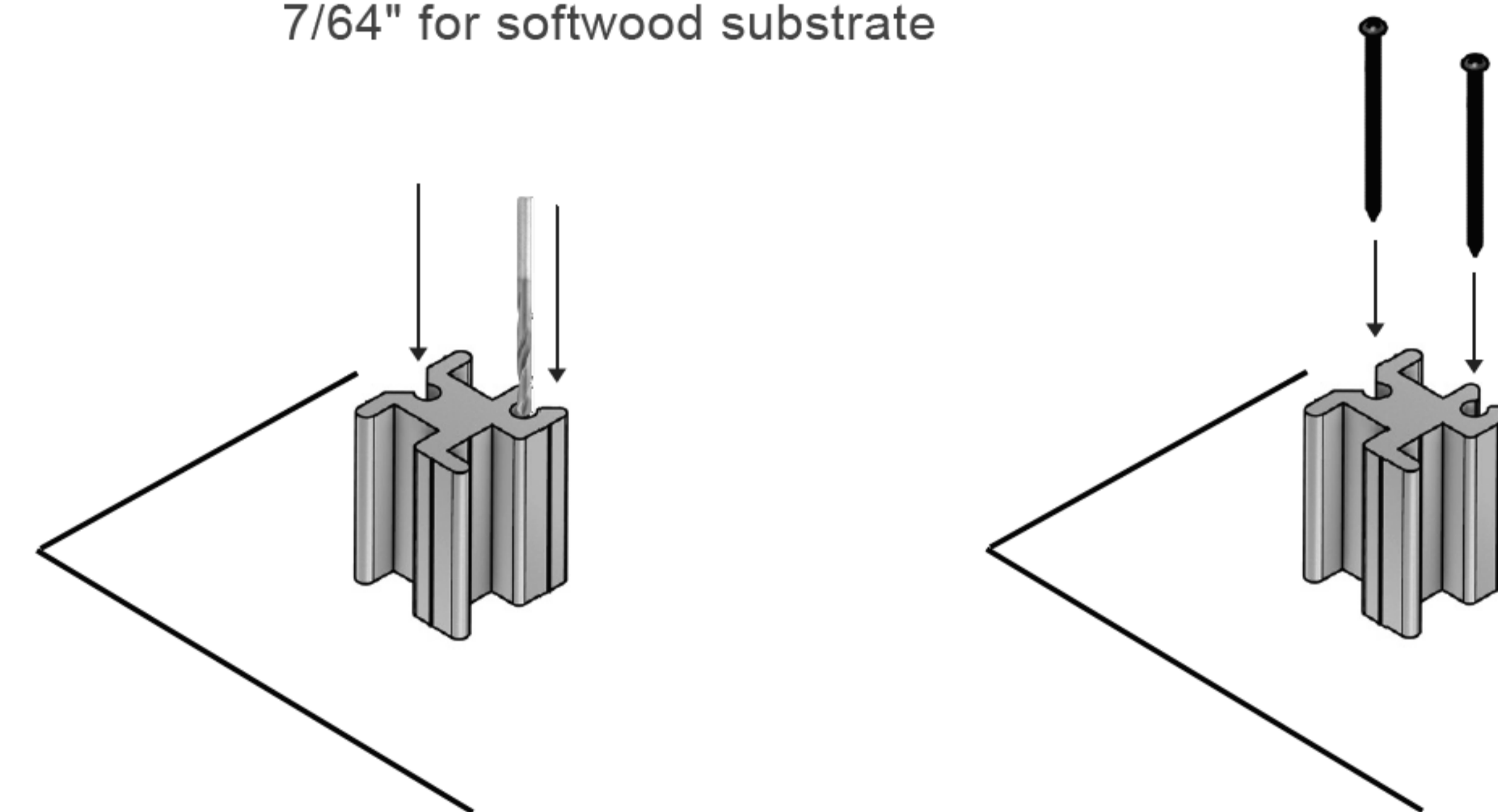

③

Slide post over the base. Glue can be used to secure the post in place. Optional: If a gap is required between the glass and the counter, insert a pan-head screw into the channel to act as a spacer.

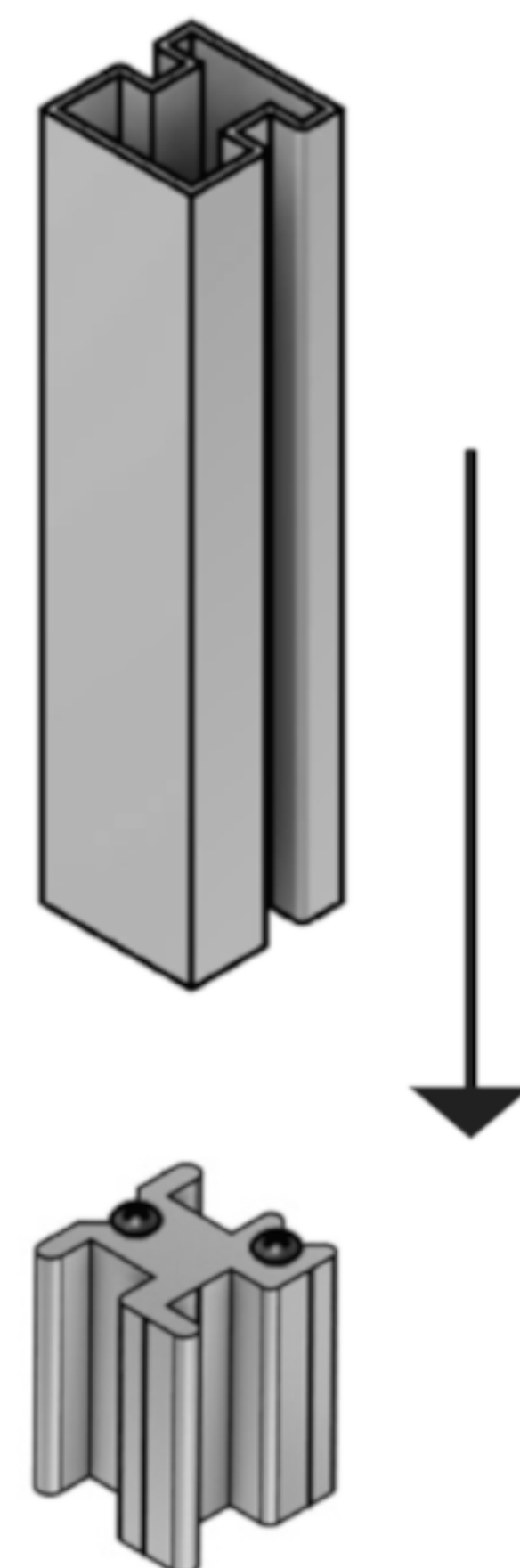
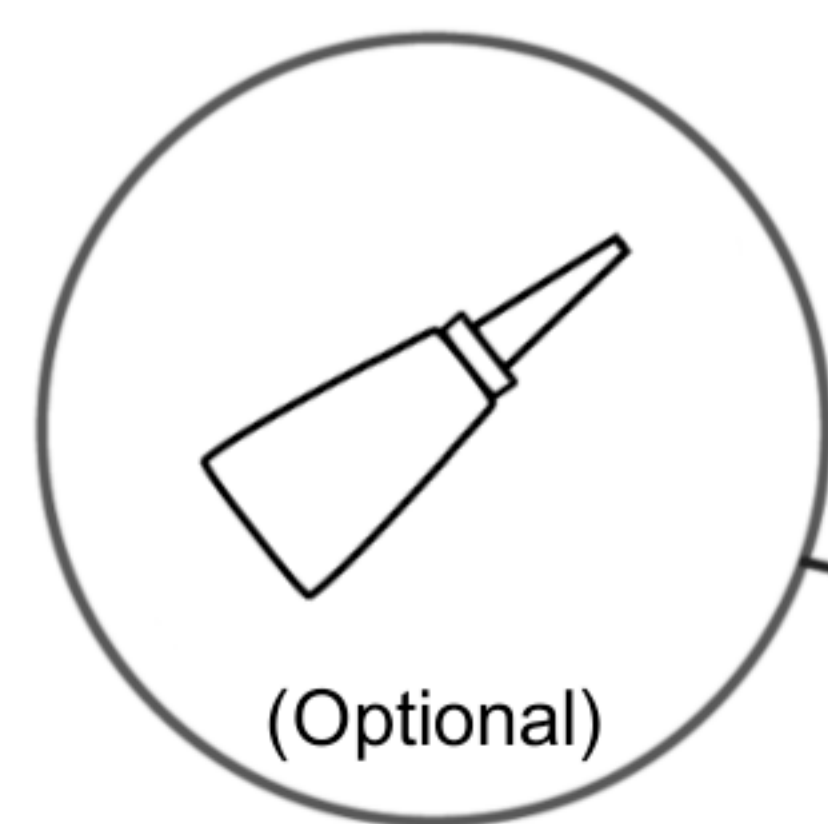

④

Slide the glass into place from the top. Use a bead of silicone to firmly affix the panel into place.

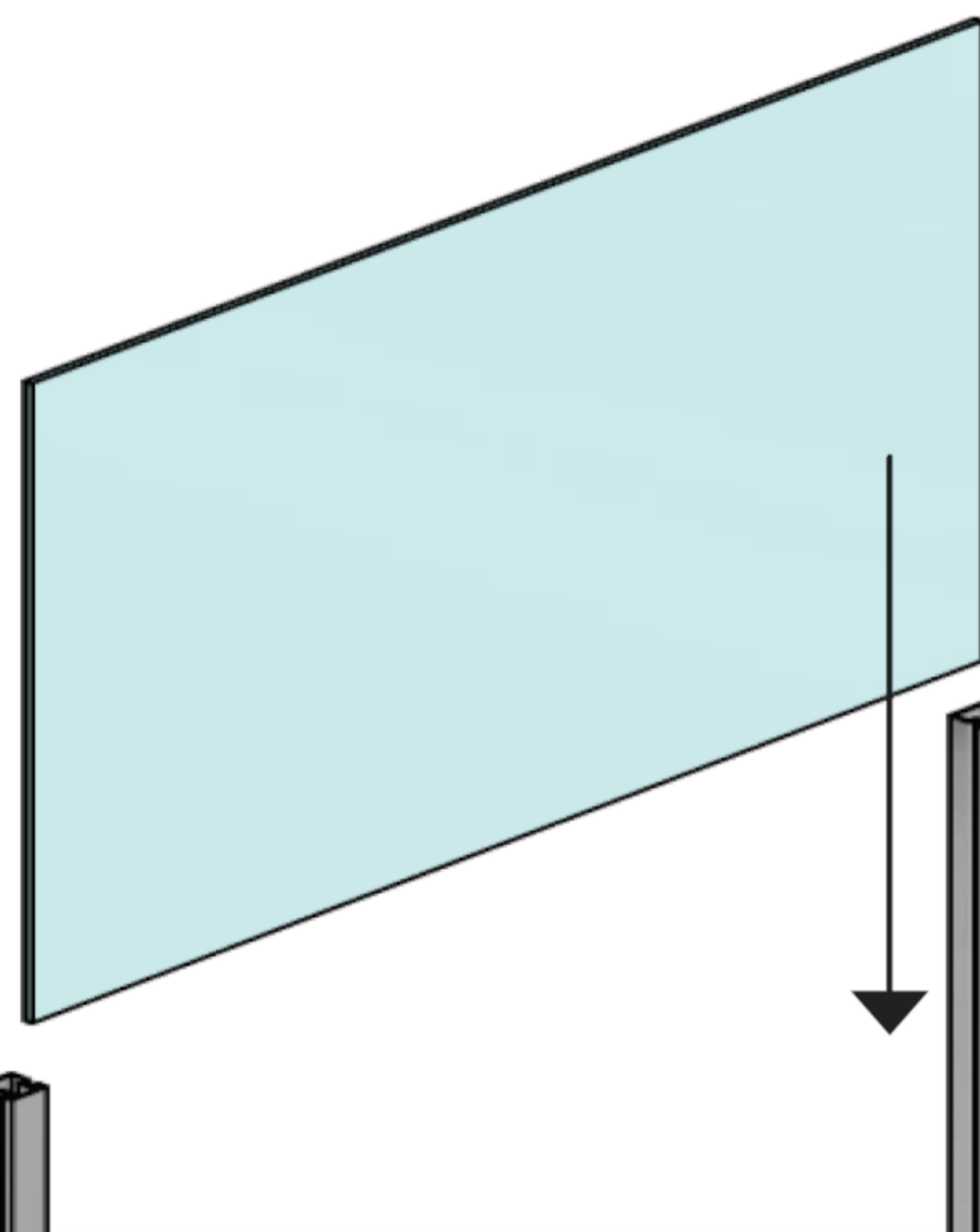

⑤

Slide cap into place to complete the installation. Glue can be used for additional strength.

