

Technical Drawing

Ref. No.:	DH12360	A/S 400 description:	LED Driver(Dimming)
-----------	---------	----------------------	---------------------

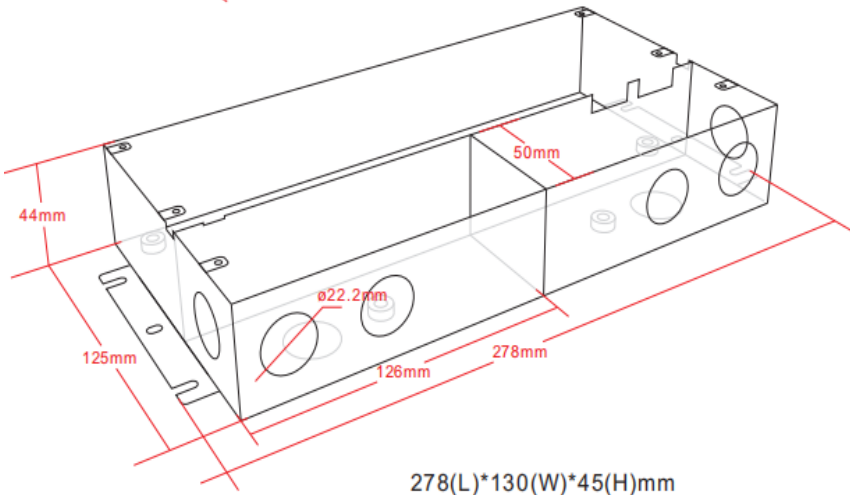

278(L)*130(W)*45(H)mm

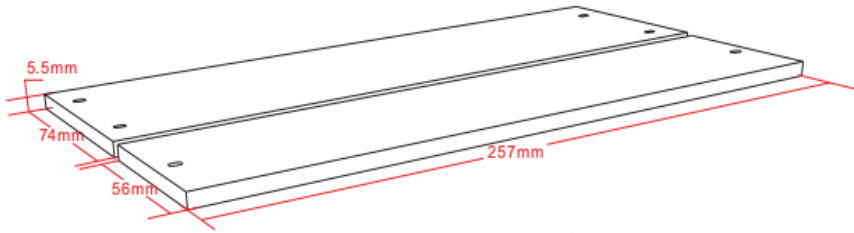