

Plating: Plain

Thread Size	5/16-18
A Flange Diameter	7/8
B Barrel Height	1/2
C Barrel Diameter	.370
D	1/4
Drill Size	3/8
T Material Thickness	.059

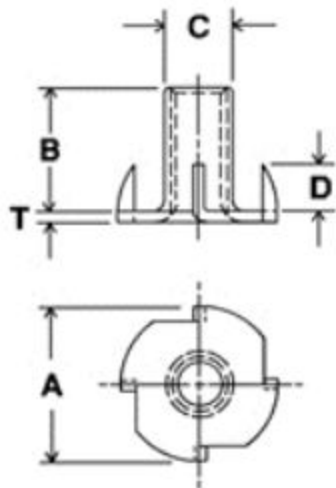

Steel