

Square T ubular Handle

Code	Material	C/C
87D2S08xxx	SS304	(8") 203 mm

► Measurements

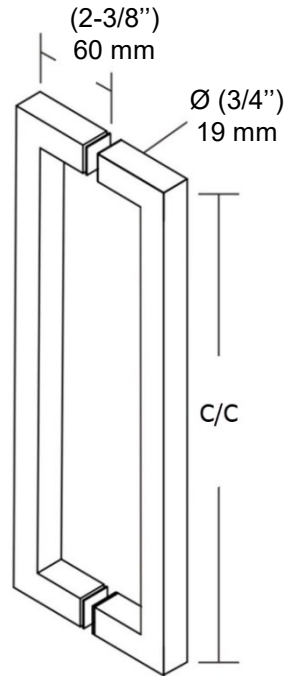
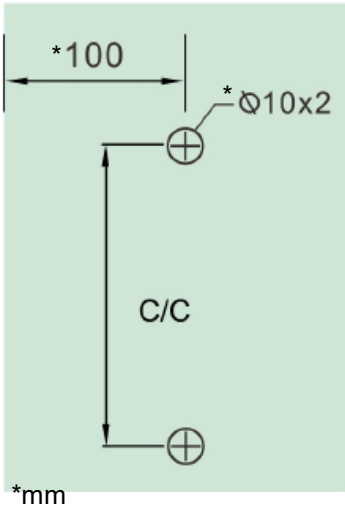

► Components

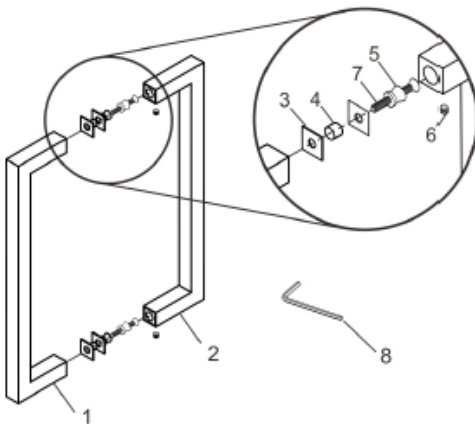

#	Name	Qty
1	Exterior Handle	1
2	Interior Handle	1
3	Gasket	4
4	Plastic Washer	2
5	Collar	2
6	Set Screw	2
7	Screw M6x50mm	2
8	Allen Key 2.5mm	1

Square Tubular Handle

► Installation

Install the exterior handle as shown with one gasket and metal washer on each side of the glass.

*Philips screwdriver not included

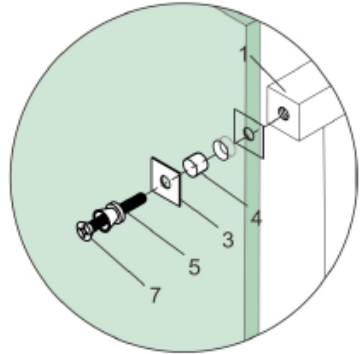

Install the interior handle onto the collars.

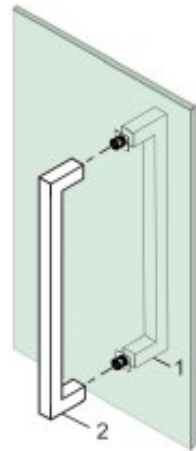

Install the set screws and tighten with the Allen key to finish the installation

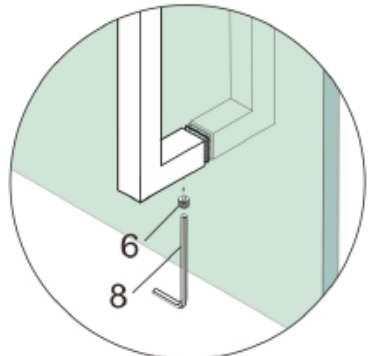

Poignée tubulaire carrée

Code	Material	C/C
87D2S08xxx	SS304	(8") 203 mm

► Dimensions

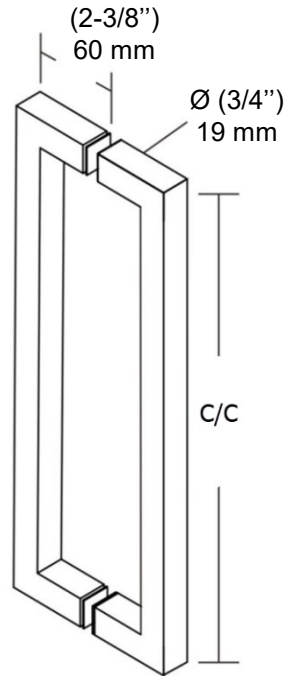
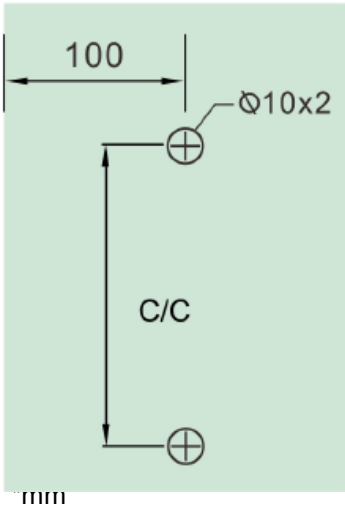

► Composantes

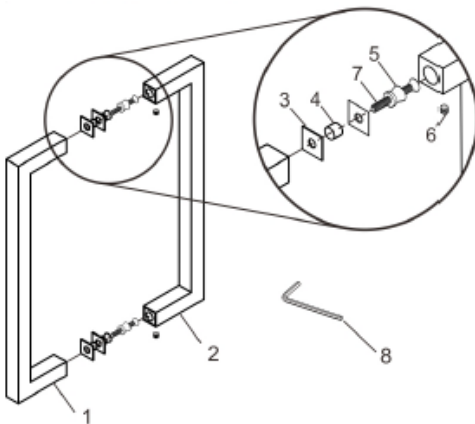

#	Nom	Qté
1	Poignée extérieure	1
2	Poignée intérieure	1
3	Joints	4
4	Rondelles en plastique	2
5	Collier	2
6	Vis	2
7	Vis M6x50mm	2
8	Clé Allen 2.5mm	1

Poignée tubulaire carrée

► Installation

Installez la poignée extérieure comme illustré avec un joint et une rondelle métallique de chaque côté du verre.

*Tournevis Philips non inclus

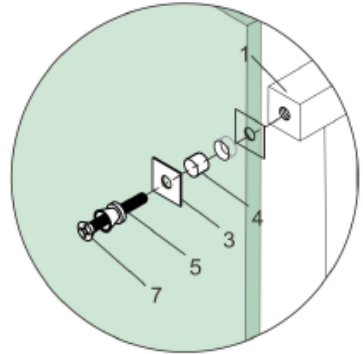

Installez la poignée intérieure sur les colliers.

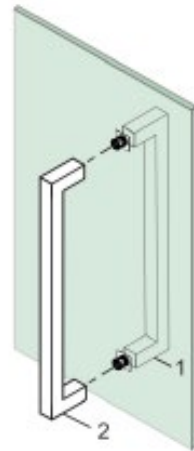

Installez les vis de réglage et serrez avec la clé Allen pour terminer l'installation

