

Heavy Duty Ladder Pull

Code	Material	H	C/C
721LH84xxx	SS304	(84") 2133 mm	(72") 1828 mm

*tube thickness 3mm

Measurements

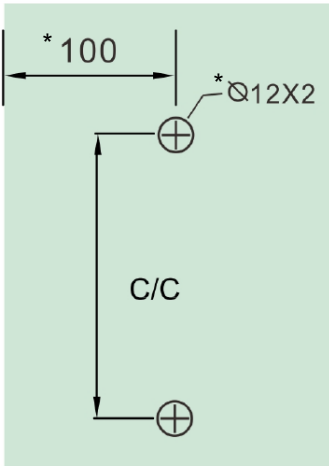

*mm

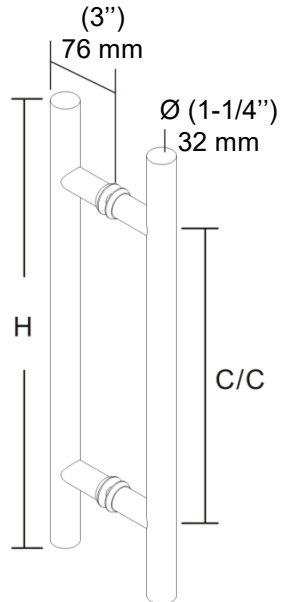

Components

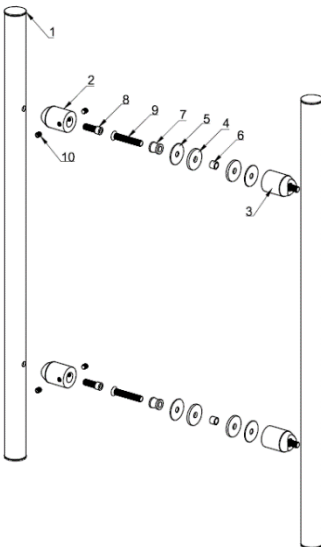

#	Component	Qty
1	Handle	2
2	Mounting Rod	2
3	Mounting Rod	2
4	Gasket	4
5	Metal washer (Ø32mm)	4
6	Plastic Spacer	2
7	Brass Collar	2
8	Fixing Screw (5/16"-18 x 30mm)	2
9	Mounting Screw (5/16" -18 x 50mm)	2
	Mounting Screw (5/16"-18 x 80mm)	2
10	Set Screw (M6 x 10mm)	4

Heavy Duty Ladder Pull

► Installation

Install the exterior handle as shown with one gasket and metal washer on each side of the glass.

*Philips screwdriver not included

*Use the 50mm screw for glass doors 8-12mm thick

*Use the 80mm screw for wood doors 35-50mm thick

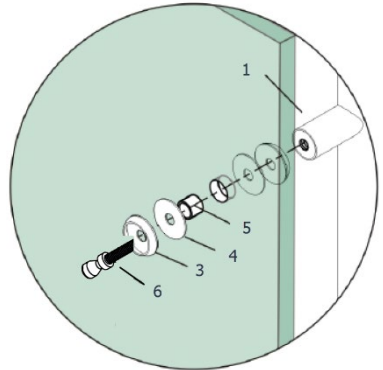

Install the interior handle onto the screws.

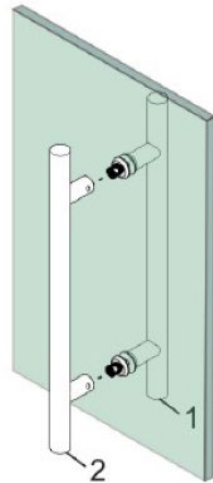

Install the set screws and tighten with the Allen key to finish the installation

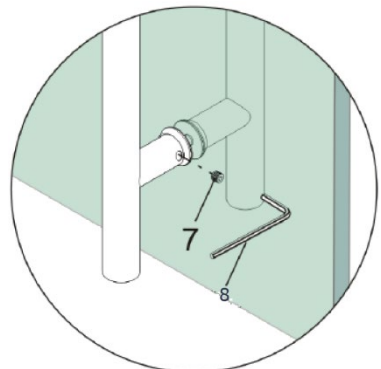

Poignée échelle robuste

Code	Matériel	H	C/C
721LH84xxx	SS304	(84") 2133 mm	(72") 1828 mm

*épaisseur du tube 3mm

► Dimensions

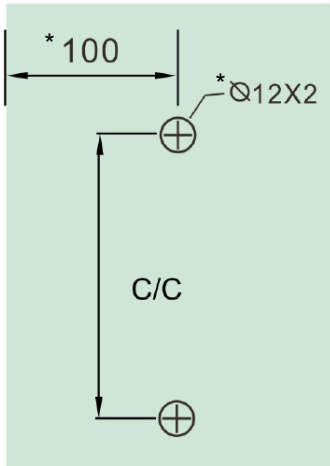

*mm

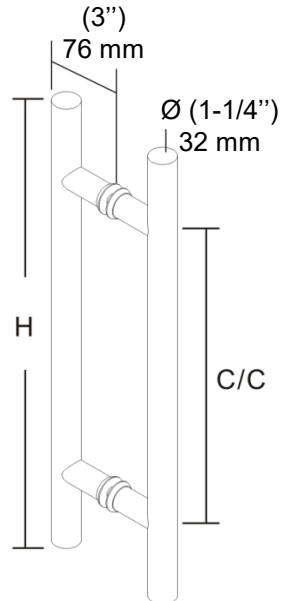

► Composantes

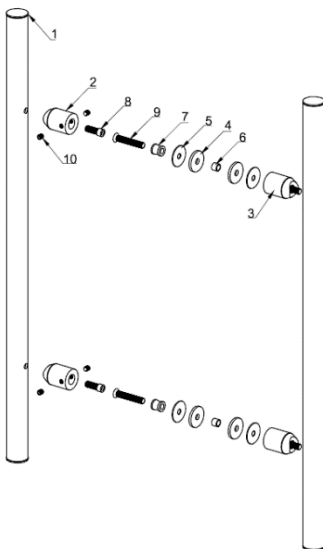

#	Composante	Qté
1	Poignée	2
2	Tige de montage	2
3	Tige de montage	2
4	Joint	4
5	Rondelle en metal (Ø32mm)	4
6	Rondeelle en plastique	2
7	Collet	2
8	Vis (5/16"-18 x 30mm)	2
9	Vis de montage (5/16" -18 x 50mm)	2
	Vis de montage (5/16"-18 x 80mm)	2
10	Vis (M6 x 10mm)	4

Poignée échelle robuste

► Installation

Installez la poignée extérieure comme illustré avec un joint et une rondelle métallique de chaque côté du verre.

*Tournevis Philips non inclus

*Utilisez la vis de 50 mm pour les portes en verre de 8-12 mm

*Utilisez la vis de 80 mm pour les portes en bois de 35-50 mm

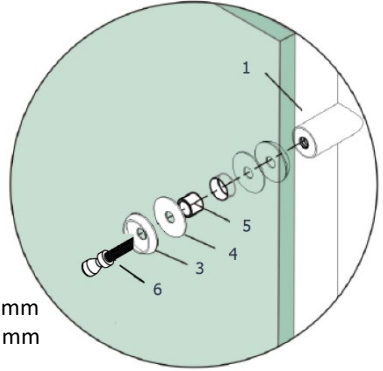

Installez la poignée intérieure sur les vis.

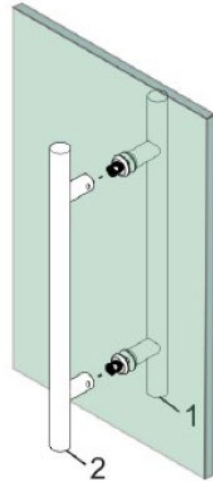

Installez les vis de réglage et serrez avec la clé Allen pour terminer l'installation

