

# Round Ladder Handle

Code	Material	H	C/C
705362432SSxxx	SS316	(36") 914 mm	(24") 609 mm

## Measurements

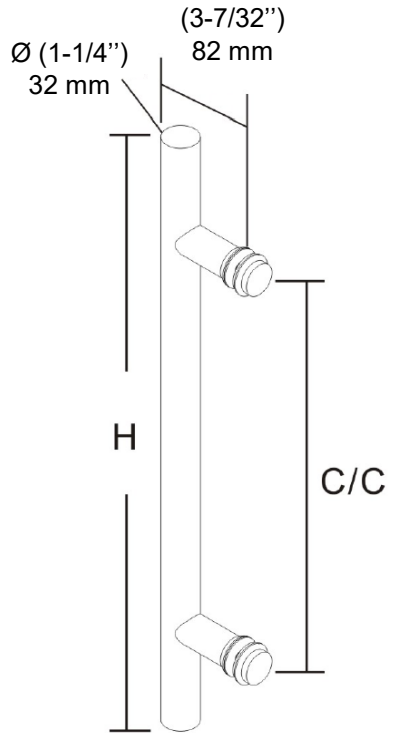
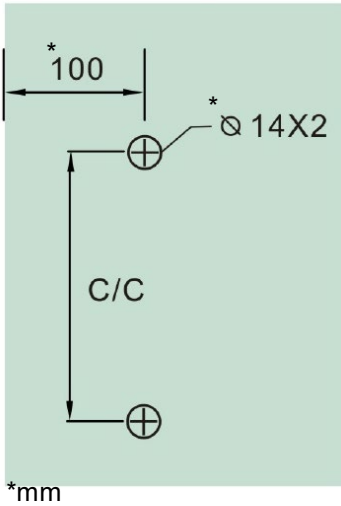

## Components

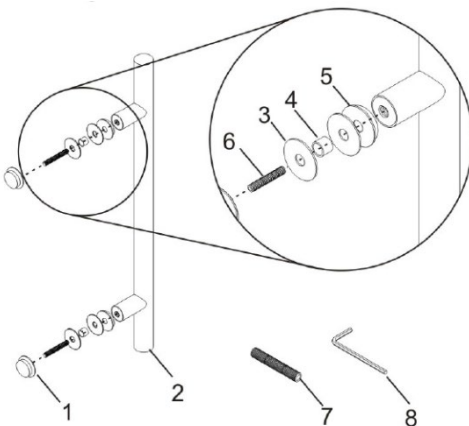

#	Name	Qty
1	Knob	2
2	Handle	1
3	Gasket	4
4	Washer	2
5	Metal Washer dia32mm	2
6	Screw M8x35mm	2
7	Screw M8x80mm	2
8	Allen Key 4mm	1

## Round Ladder Handle

### ► Installation

Install the handle as shown with the metal washer on the handle side and a gasket on either side of the glass

\*Philips screwdriver not included

\*Use the 35mm screw for glass doors 8-12mm thick

\*Use the 80mm screw for wood doors 35-50mm thick

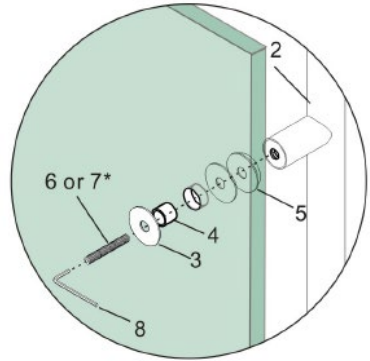

Install the knobs onto the mounting screws

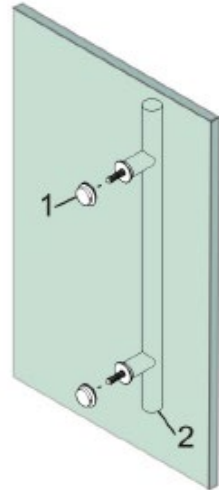

Use a standoff wrench to tighten the knobs and finish the installation

\*Standoff wrench not included

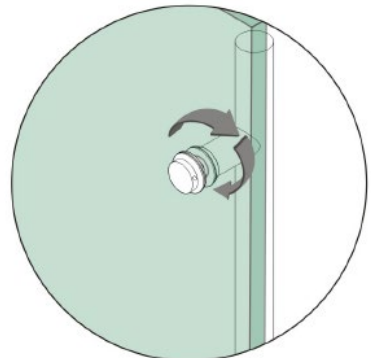

# Poignée échelle ronde

Code	Matériel	H	C/C
705362432SSxxx	SS316	(36") 914 mm	(24") 609 mm

## ► Dimensions

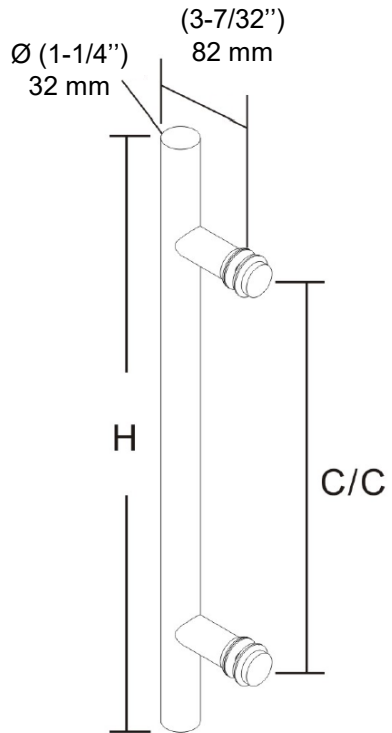
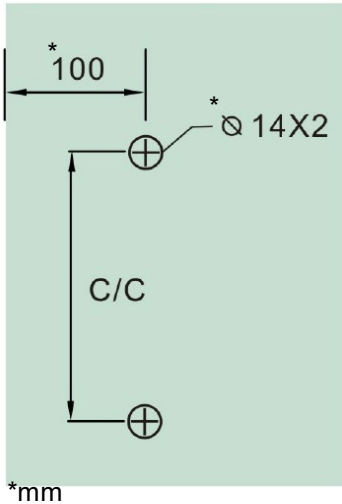

## ► Composantes

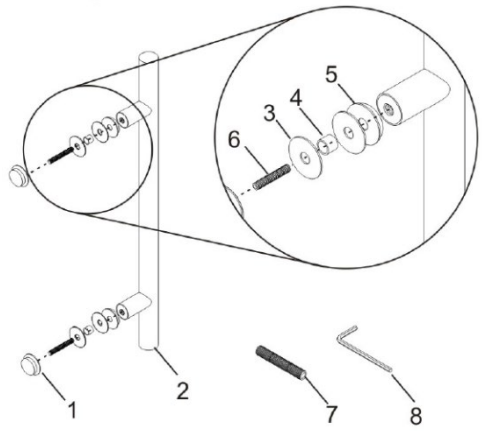

#	Nom	Qté
1	Bouton	2
2	Poignée	1
3	Joint	4
4	Rondelle	2
5	Rondelle en métal 32mm dia	2
6	Vis M8x35mm	2
7	Vis M8x80mm	2
8	Clé Allen 4mm	1

## Poignée échelle ronde

### ► Installation

Installez la poignée comme indiqué avec la rondelle métallique du côté de la poignée et un joint de chaque côté du verre

\*Tournevis Philips non inclus

\*Utilisez la vis de 35 mm pour les portes en verre de 8-12 mm

\*Utilisez la vis de 80 mm pour les portes en bois de 35-50

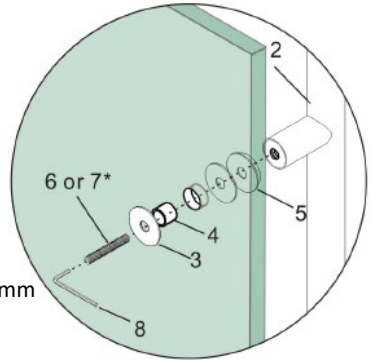

Installez les boutons sur les vis de montage

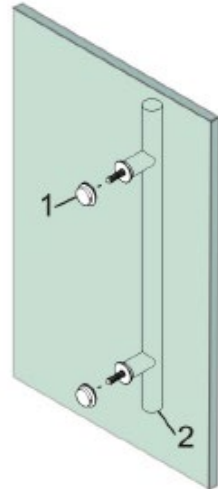

Utilisez une clé de serrage pour entretoise pour serrer les boutons et terminer l'installation

\*Clé de serrage non inclus

