

REV-A-SHELF® Wood Classics™

Installation Instructions for 38" Half Moon Lazy Susan

(Right Side Illustration Only)

IMPORTANT: Before you begin, familiarize yourself with the kit contents, identify all parts, read through all instruction information and have the necessary tools on hand to get started.

CUSTOMER SERVICE: Toll Free Consumer Help Line for your product questions during the weekday business hours: **800-626-1126**

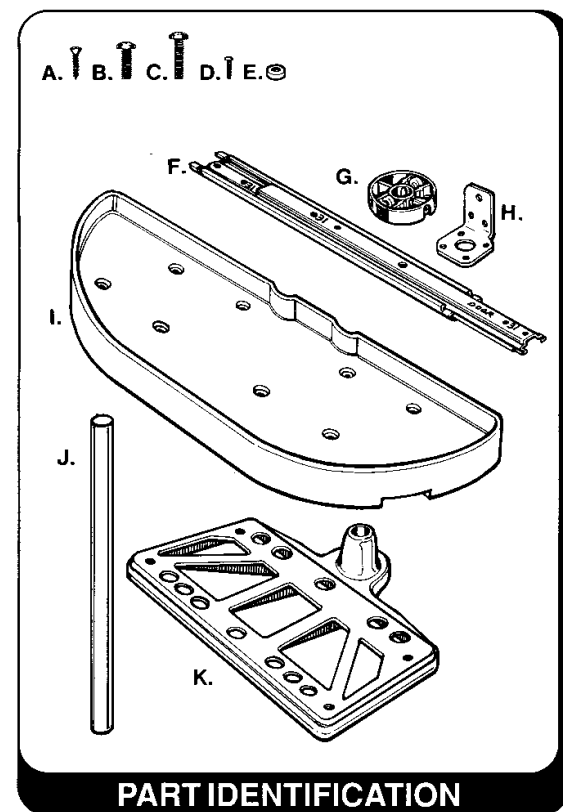

- PART IDENTIFICATION**
- A. #8 x 3/4" Oval Head Phillips Wood Screw - 7 req.
 - B. 1/4 - 20 x 3/4" Phillips Machine Screw - 4 req.
 - C. 1/4 - 20 x 1" Phillips Machine Screw - 8 req.
 - D. #10 x 1" Phillips Machine Screw - 4 req.
 - E. Plastic Screw Hole Caps - 16 req.
 - F. Slide Assembly - 2 req.
 - G. Positioner Base Assembly - 2 req.
 - H. Support Bracket - 1 req.
 - I. Half Moon Tray - 2 req.
 - J. Shaft 17" w/cap - 1 req.
 - K. Shelf Support - 2 req.

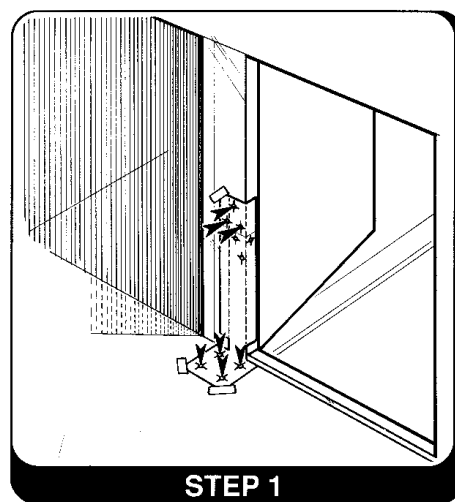

Position and tape template on inside of the face frame vertically (hinge side) as shown in illustration. Using a 1/16" diameter bit, drill 5/8" deep pilot holes through the template at the 7 arrow locations. **NOTE:** Be careful not to drill through the front of the cabinet frame.

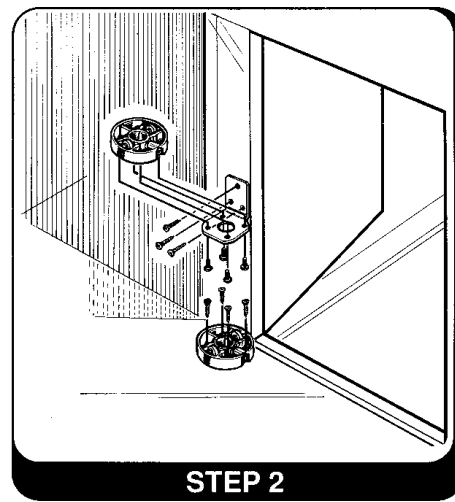

Match positioner base over 4 base holes as shown and install to cabinet bottom using four (4) #8 x 3/4" oval head wood screws. Match support bracket over 3 remaining pilot holes as shown and install to cabinet frame using three (3) #8 x 3/4" oval head wood screws. Now match the other positioner base over the 4 support bracket holes and fasten to bracket from underneath using four (4) #10 x 1/2" machine screws. Make sure to position lock down screw on positioner base assembly toward cabinet opening. **NOTE FOR BLIND LEFT CABINETS:** Support bracket installs as shown in illustration 2b.

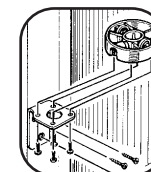
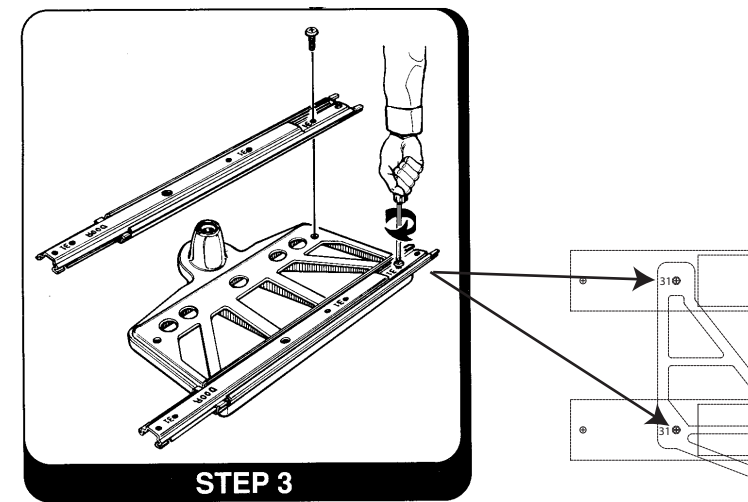
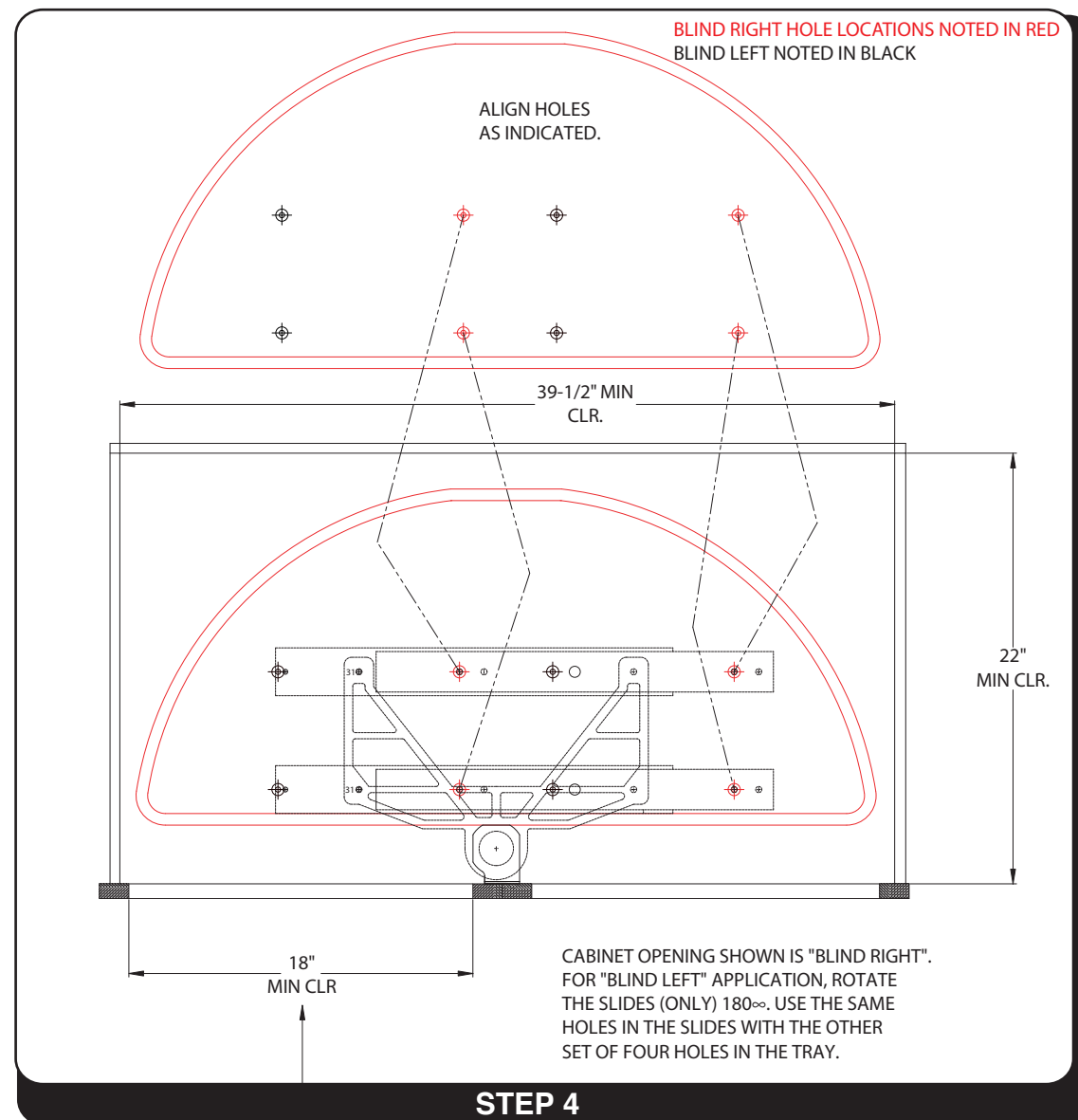

illustration 2b



Attach slides to support frame starting with the hole location noted "31" (see illustrations). **NOTE:** Place end noted "this end away from cabinet opening" **AWAY** from cabinet opening. This will ensure proper function and alignment with other hole location.



Attach trays to slides per indicated holes. Cover unused holes with provided caps.

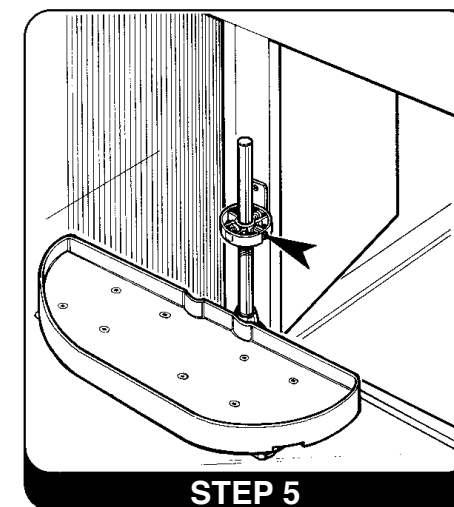

Take your pivot & slide assembly, match it over the bottom positioner base and insert the shaft through the top positioner base until the shaft bottom (open end) sets on cabinet bottom. Now tighten the set screws on both positioner bases (arrow points out top set screw). Be sure to tighten bottom positioner base set screw (not visible).

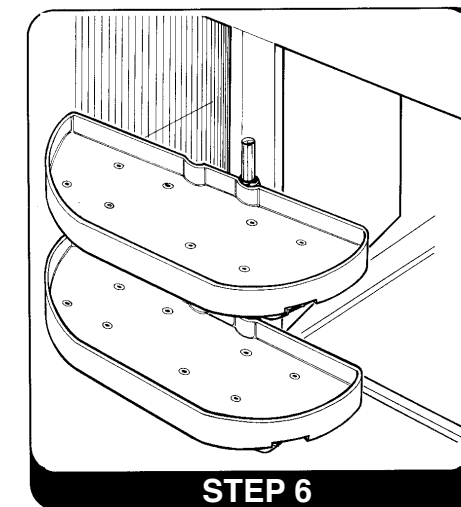

Now slide the pivot & slide assembly on shaft so it rests on the top positioner base. Your installation is now complete and should look like the illustration.