

TRIADE PRO MAXI

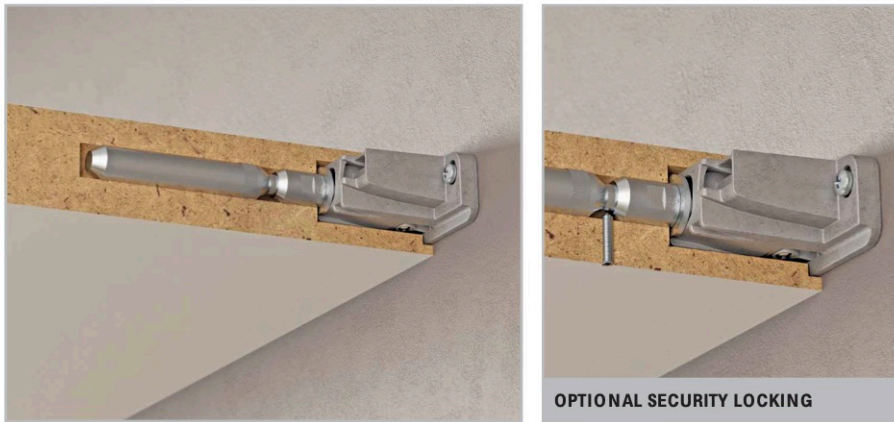

40 mm min.

40 kg per pair for shelf 400 mm deep

SPECIFICATION

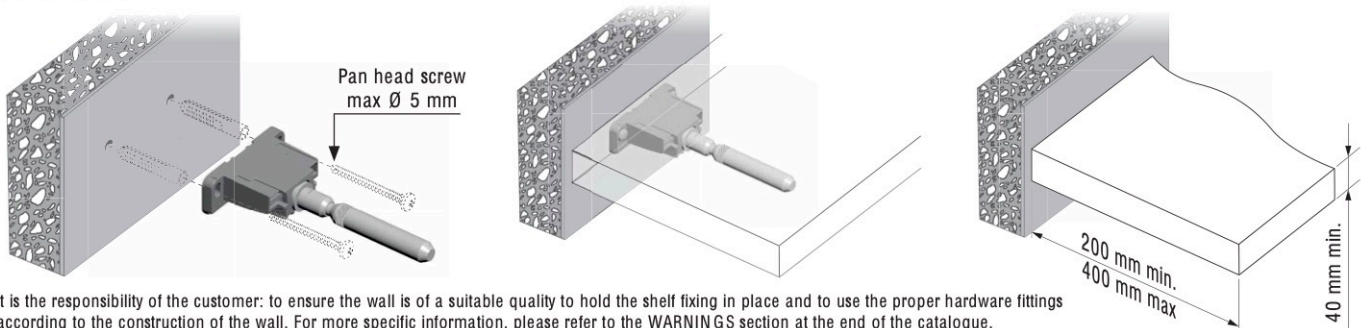

It is the responsibility of the customer: to ensure the wall is of a suitable quality to hold the shelf fixing in place and to use the proper hardware fittings according to the construction of the wall. For more specific information, please refer to the WARNINGS section at the end of the catalogue.

ADJUSTMENT

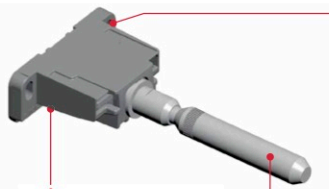

VERY IMPORTANT

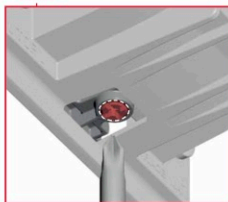

Screw to lock when adjustments are finished.

BRACKET ALIGNMENT

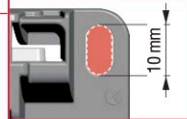

LATERAL ADJUSTMENT

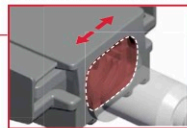

INCLINATION ADJUSTMENT

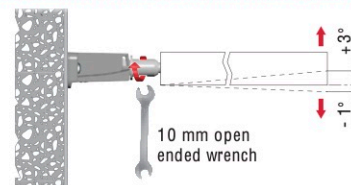
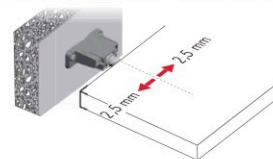
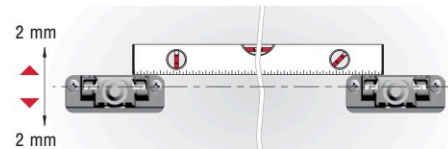
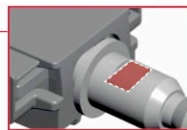

CAPACITY LOADING CHART

(The figures refer to 2 shelf supports)

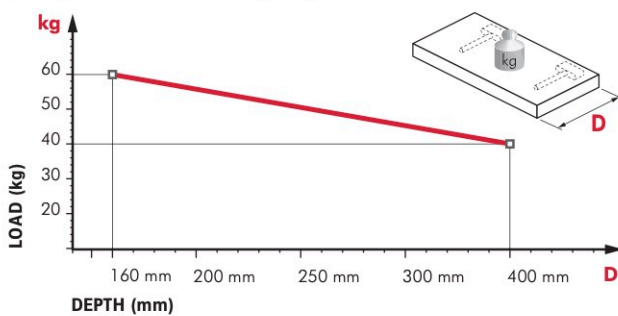

RECOMMENDED NUMBER OF TRIADE PRO MAXI PER SHELF

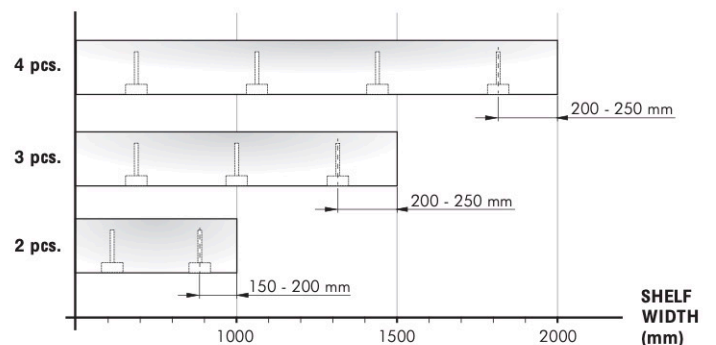

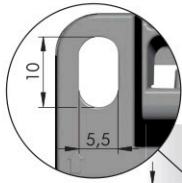
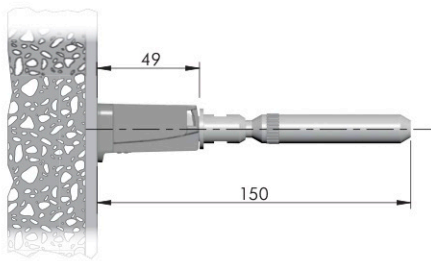

VERY IMPORTANT
Centre of the hole is shifted 3,5 mm upwards.
Please keep in mind when levelling the shelf.

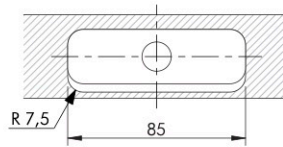
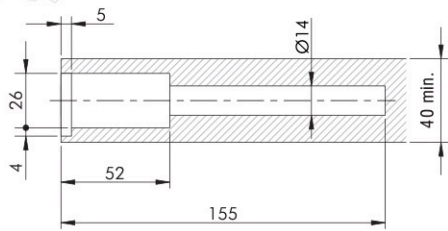
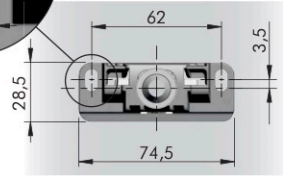

TRIADE PRO MAXI AND BRACKET



OPTIONAL SECURITY LOCKING



TRIADE PRO MAXI wall bracket

Pan head screw max Ø 5 mm

TRIADE PRO MAXI

Pan head screw M5 x 12 mm

The wall bracket guarantees a more stable fixing to the wall.

It is the responsibility of the customer: to ensure the wall is of a suitable quality to hold the shelf fixing in place and to use the proper hardware fittings according to the construction of the wall. For more specific information, please refer to the WARNINGS section at the end of the catalogue.

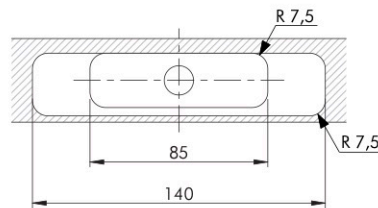
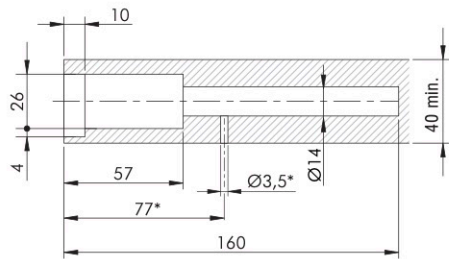

* Optional drilling for security locking with M4 grub screw placed underneath in alignment with the cavity. For details refer to Triade Pro Maxi section.

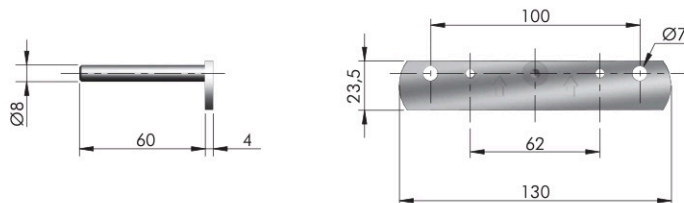

FIXING ACCESSORY

