

A  
472

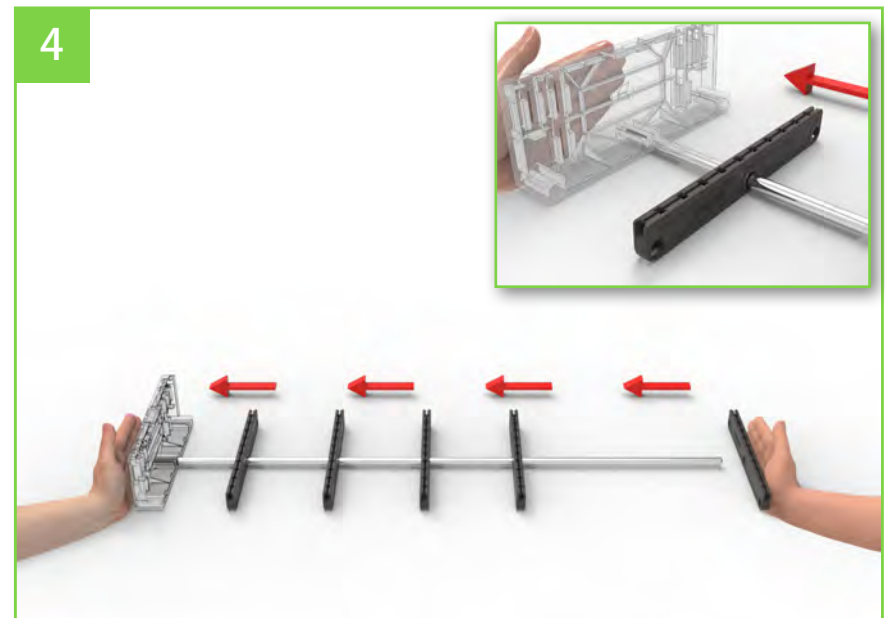

5

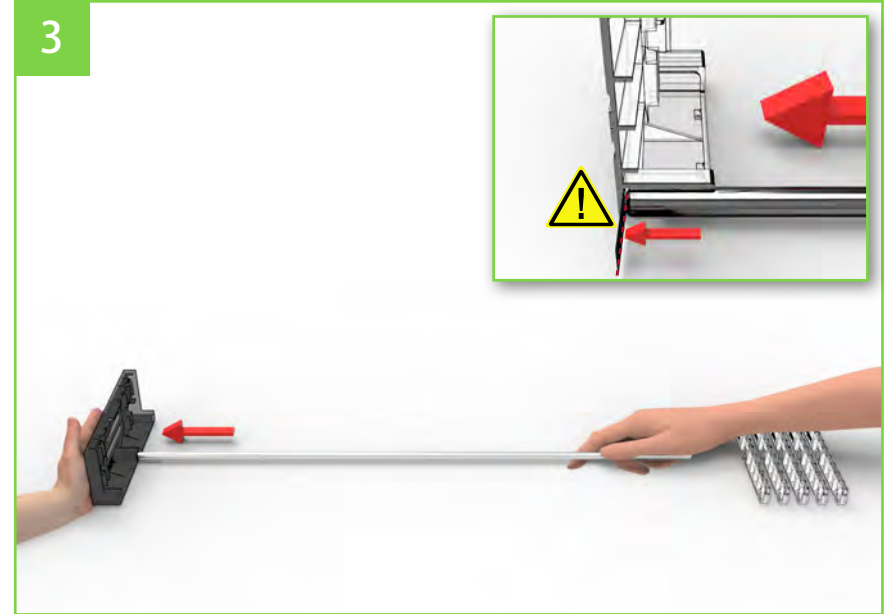
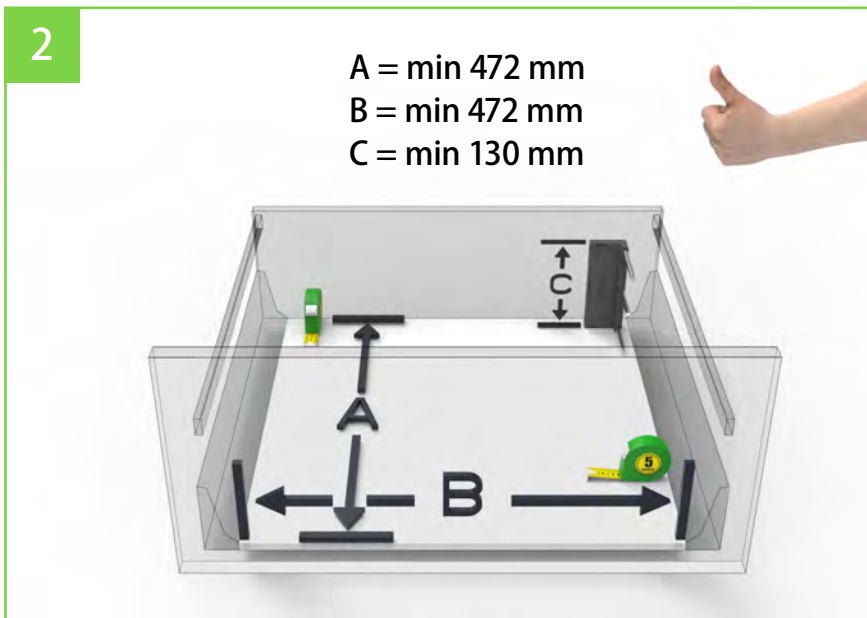
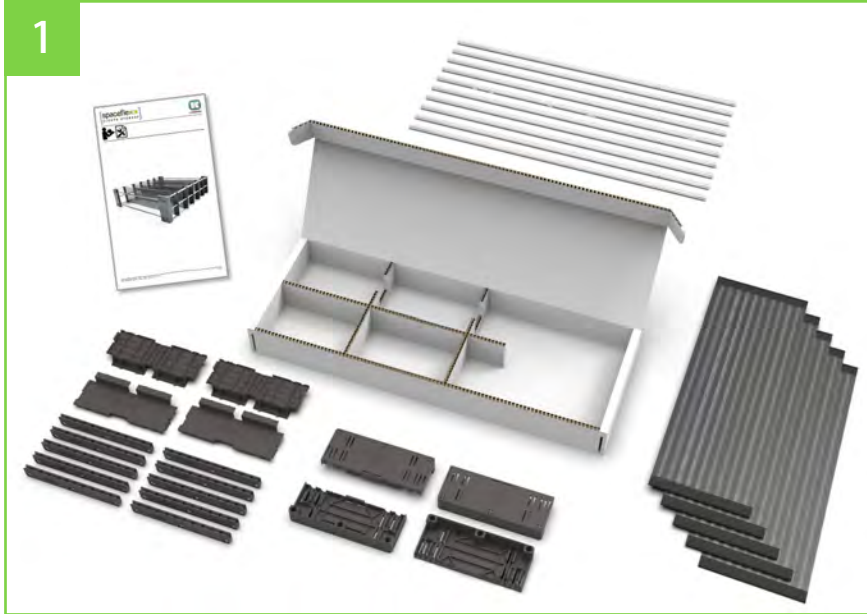
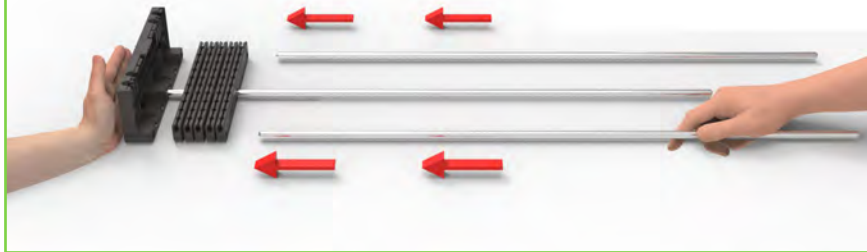
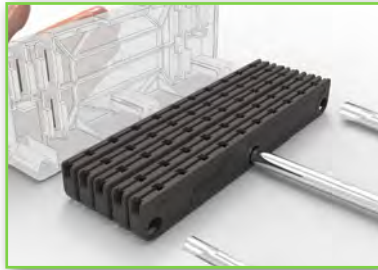

6



Press until it stops!



7

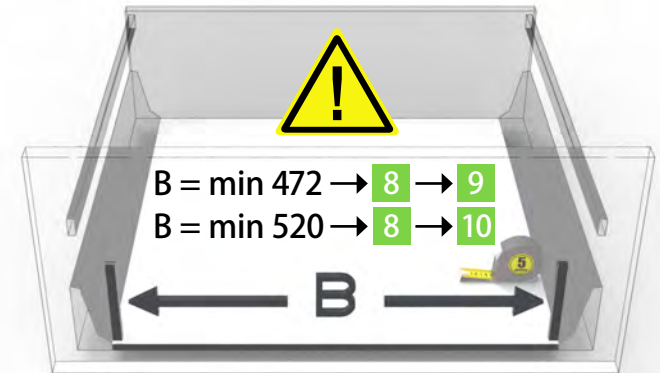

8



Installation only possible in the drawer!

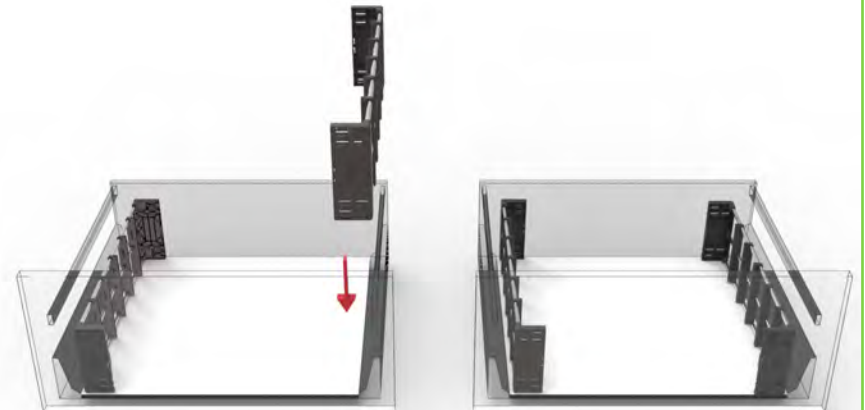

9

B = min 472 → 11

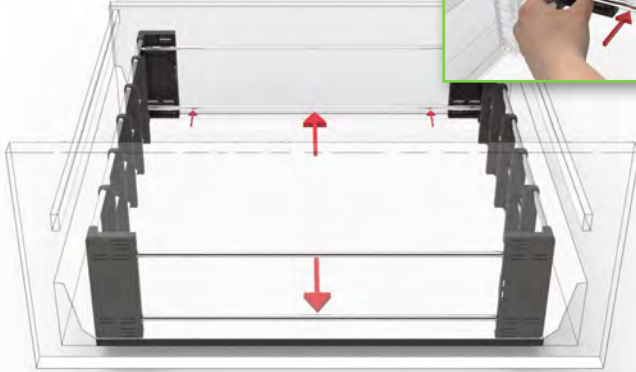

11

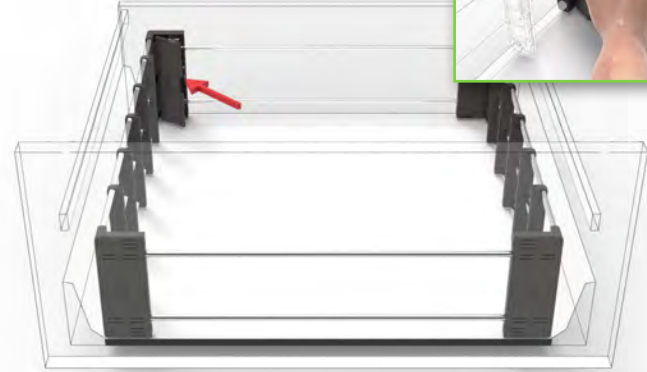

10

B = min 520 → 11

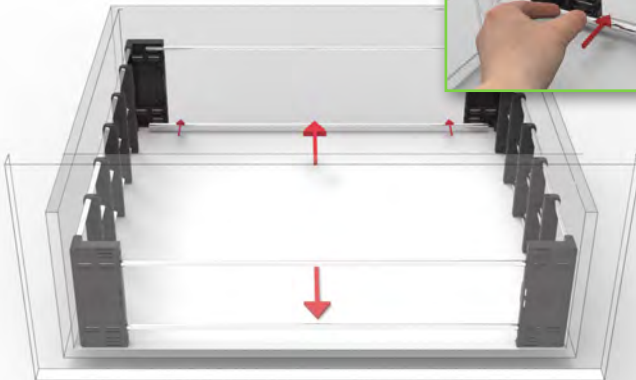

12



13

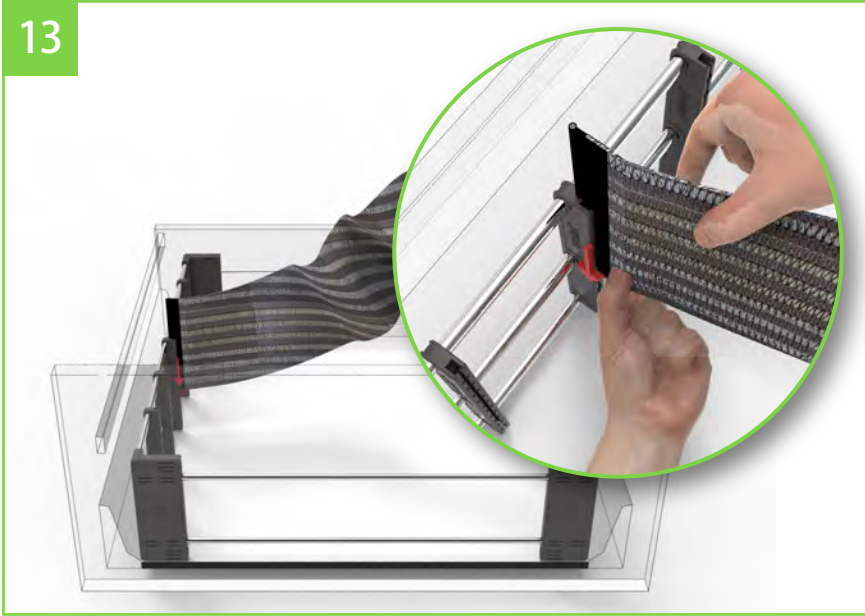

14

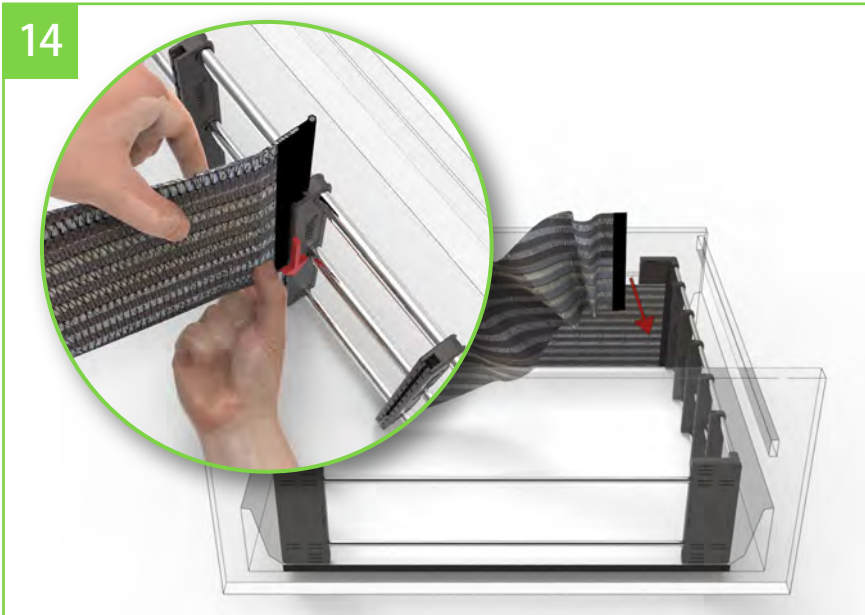

15





Before removing from the drawer the product **dismantle** as described here!

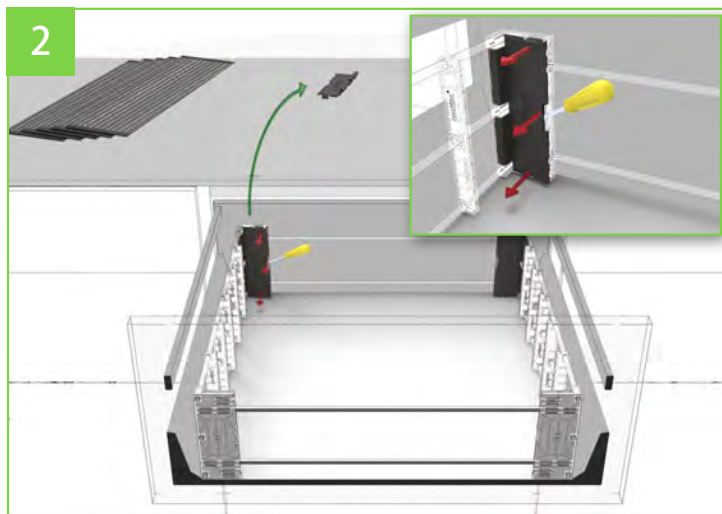
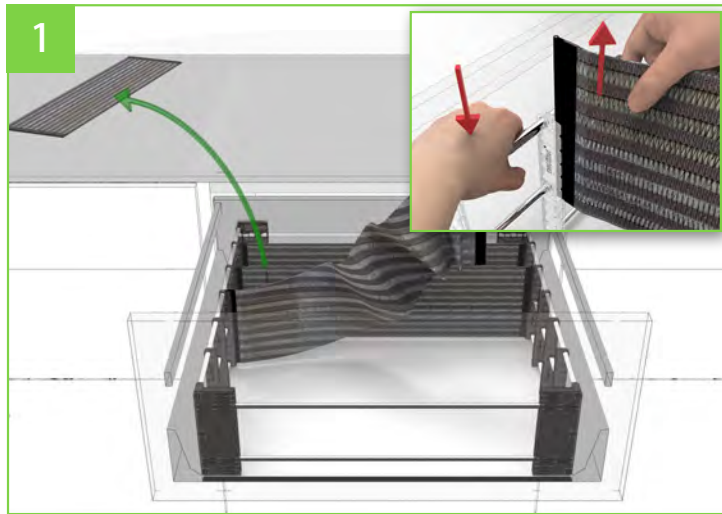

Before removing from the drawer the product **dismantle** as described here!

