

STRASS

UMBRA

ARROW
FLÈCHE

LUNA

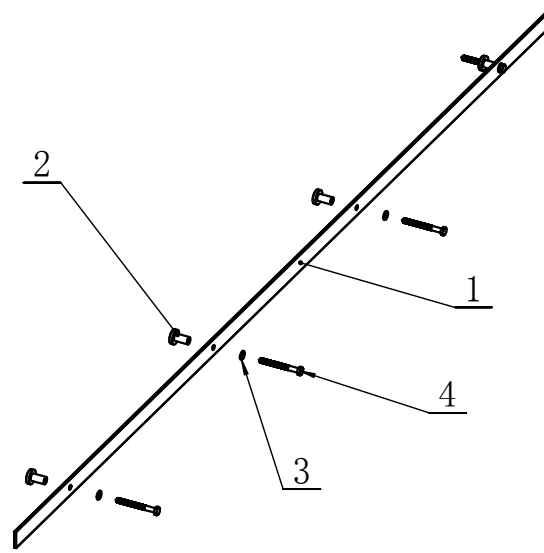

Item	DWG NO	Quantity	DIMENSIONS ARE IN mm TOLERANCES FRACTIONAL ± ANGULAR: MACH ± BEND ± ONE PLACE DECIMAL ± TWO PLACE DECIMAL ±	NAME	DATE	Richelieu Hardware		
				DRAWN				
1	Track	1	MATERIAL: Steel FINISH: Black WEIGHT(GR): 1017.22	CHECKED		RICHELIEU /VENDOR ITEM NUMBER 246TYL20390		
2	Clamp	4		ENG APPR.				
3	Washer	4		MFG APPR.		SIZE A	DWG.NO. Track	REV. 0
4	Screw	4		Q.A.				
				COMMENTS:	1	DO NOT SCALE DRAWING		
						SHEET 1 OF 1		

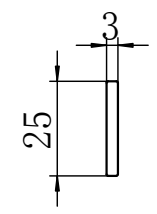
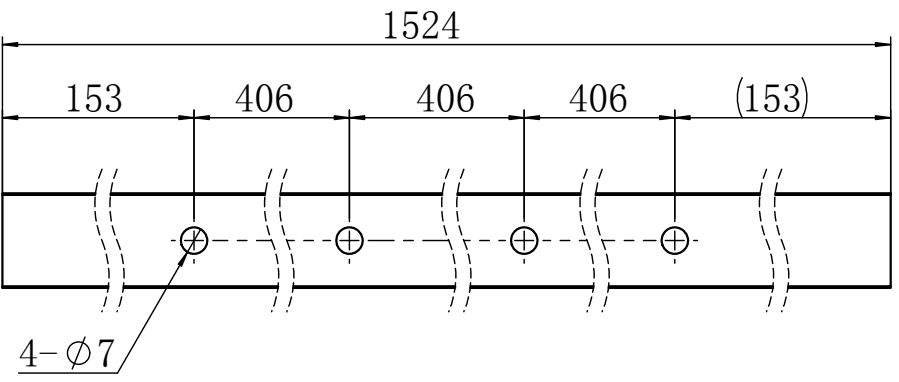
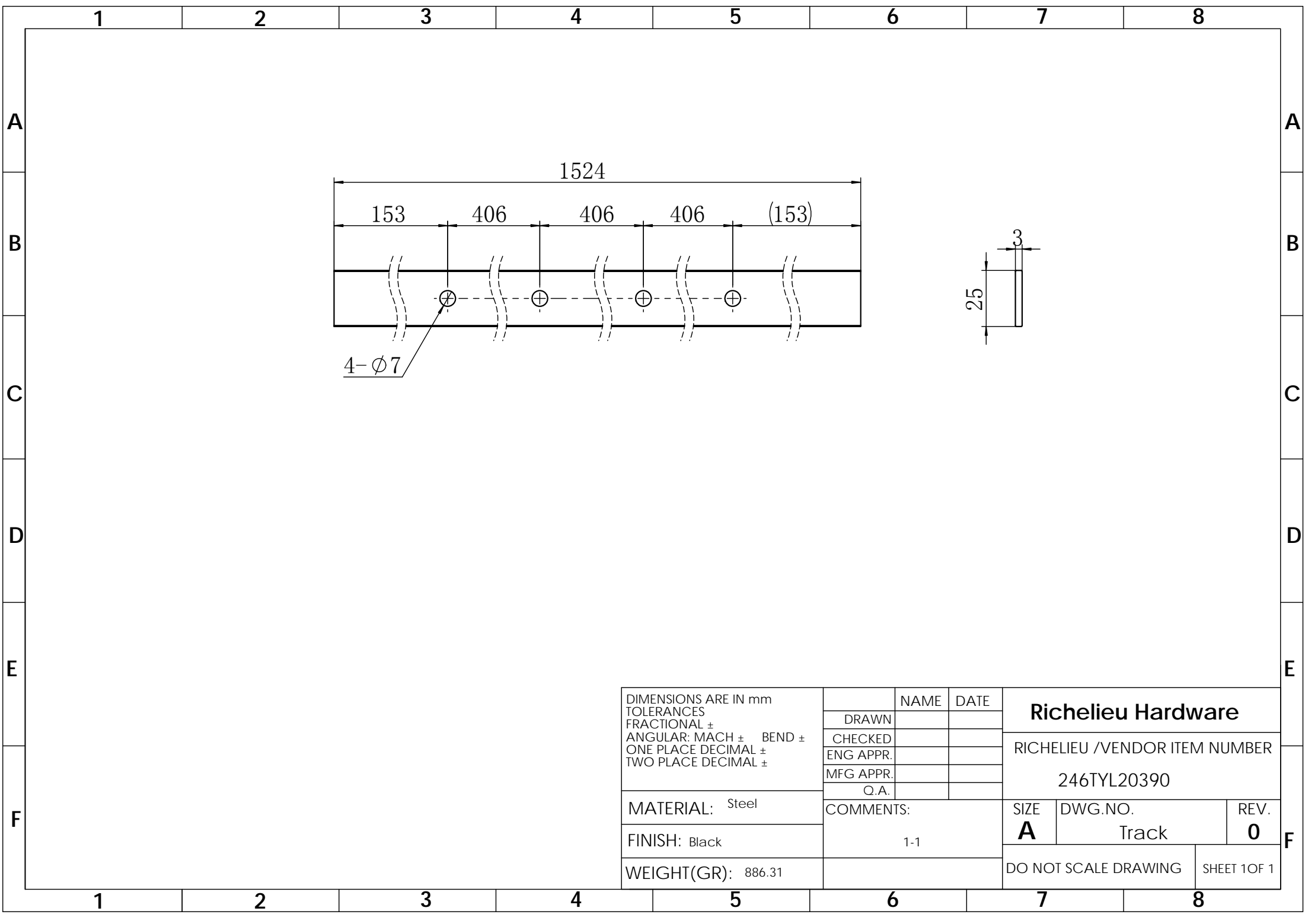

DIMENSIONS ARE IN mm TOLERANCES FRACTIONAL ± ANGULAR: MACH ± BEND ± ONE PLACE DECIMAL ± TWO PLACE DECIMAL ±		NAME	DATE	Richelieu Hardware		
	DRAWN					
	CHECKED			RICHELIEU /VENDOR ITEM NUMBER 246TYL20390		
	ENG APPR.					
	MFG APPR.					
	Q.A.			SIZE	DWG.NO.	REV.
MATERIAL: Steel	COMMENTS:		1-1	A	Track	0
FINISH: Black				DO NOT SCALE DRAWING		SHEET 1 OF 1
WEIGHT(GR): 886.31						

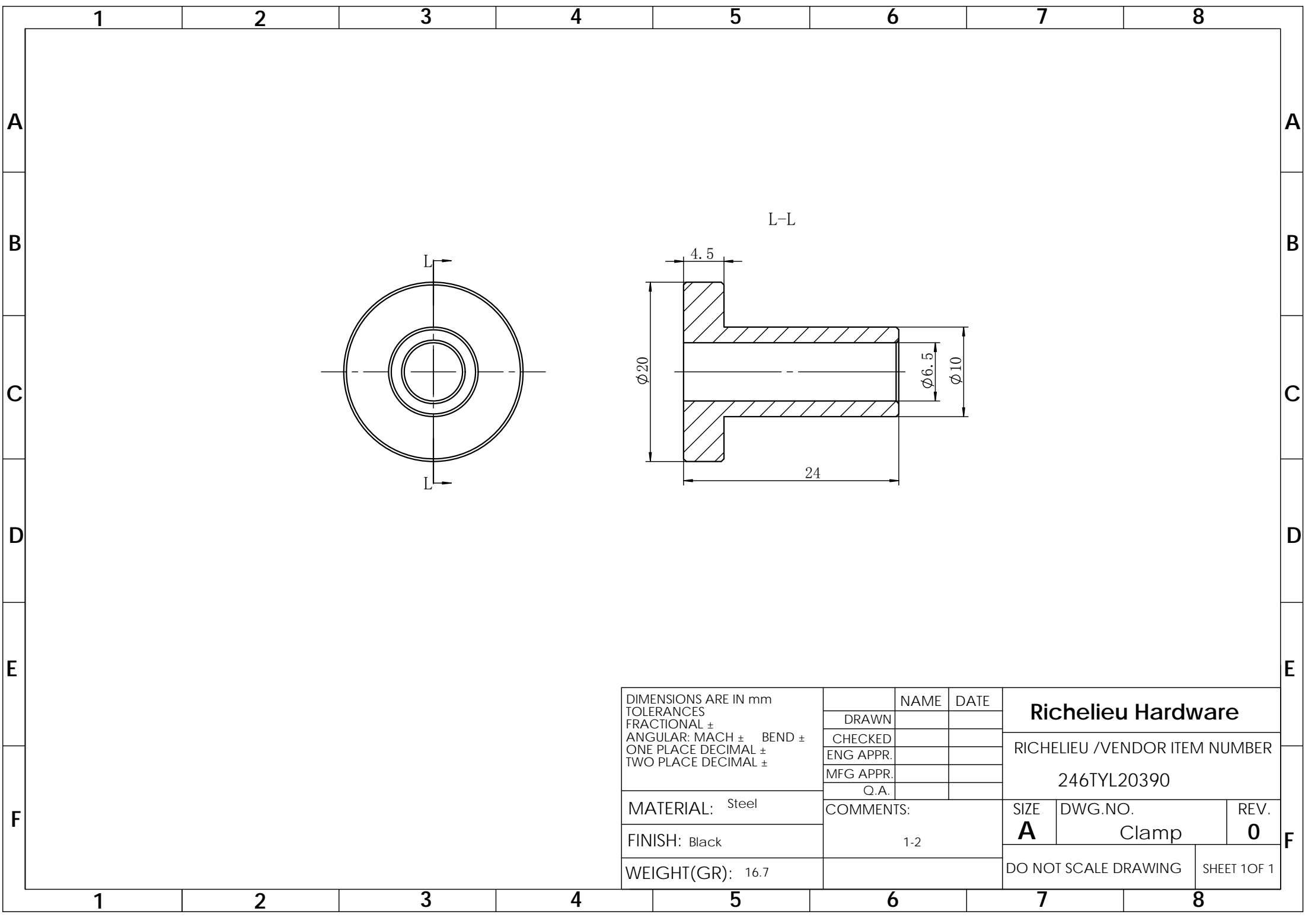

DIMENSIONS ARE IN mm TOLERANCES FRACTIONAL ± ANGULAR: MACH ± BEND ± ONE PLACE DECIMAL ± TWO PLACE DECIMAL ±		NAME	DATE	Richelieu Hardware		
	DRAWN					RICHELIEU /VENDOR ITEM NUMBER 246TYL20390
	CHECKED					
	ENG APPR.					
	MFG APPR.					
	Q.A.			SIZE	DWG.NO.	REV.
MATERIAL: Steel	COMMENTS: 1-2		A		Clamp	0
FINISH: Black			DO NOT SCALE DRAWING		SHEET 1OF 1	
WEIGHT(GR): 16.7						

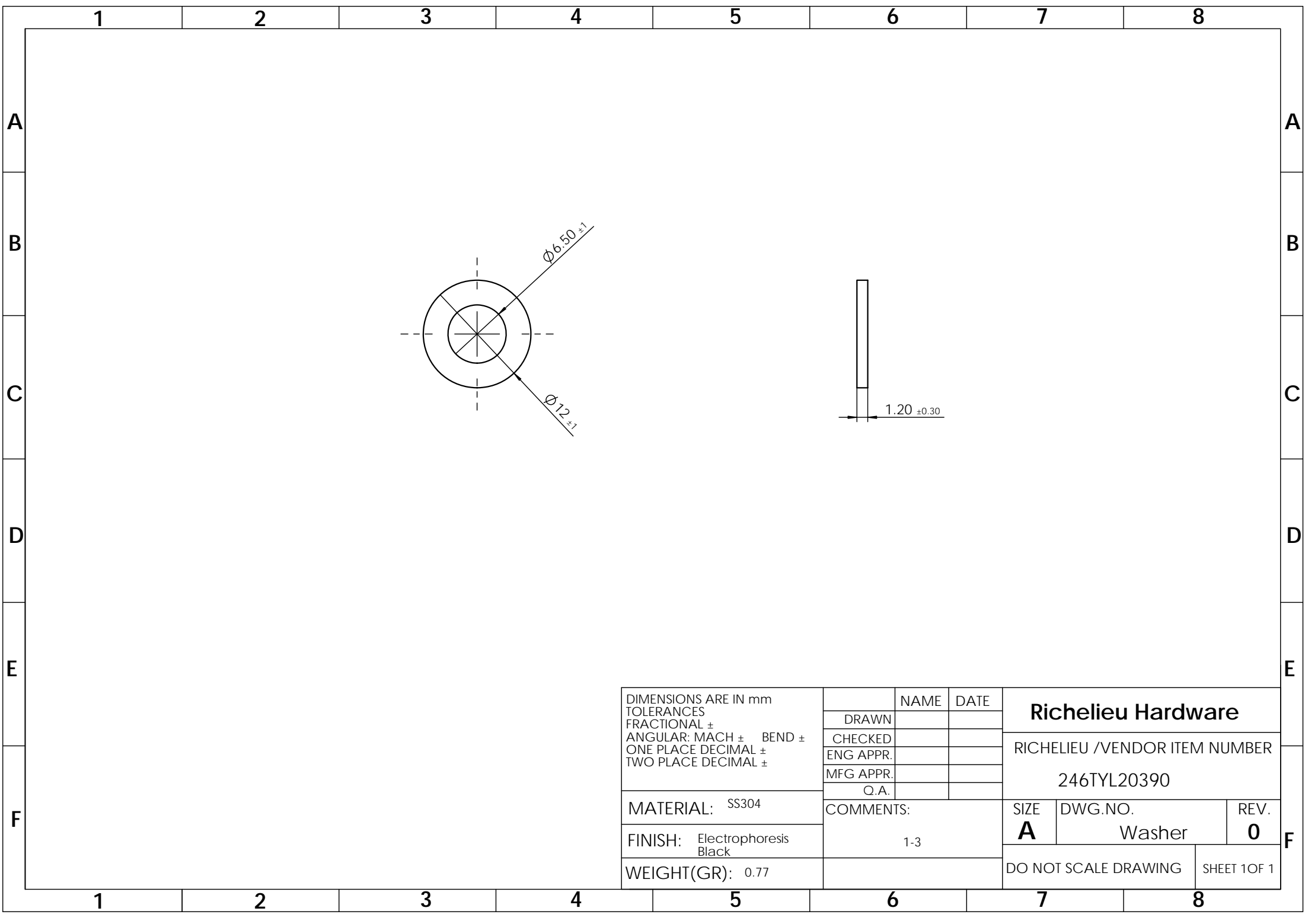

DIMENSIONS ARE IN mm TOLERANCES FRACTIONAL ± ANGULAR: MACH ± BEND ± ONE PLACE DECIMAL ± TWO PLACE DECIMAL ±		NAME	DATE	Richelieu Hardware		
	DRAWN					
	CHECKED			RICHELIEU /VENDOR ITEM NUMBER 246TYL20390		
	ENG APPR.					
	MFG APPR.					
	Q.A.			SIZE	DWG.NO.	REV.
MATERIAL: SS304	COMMENTS: 1-3		A	Washer	0	
FINISH: Electrophoresis Black			DO NOT SCALE DRAWING		SHEET 1 OF 1	
WEIGHT(GR): 0.77						

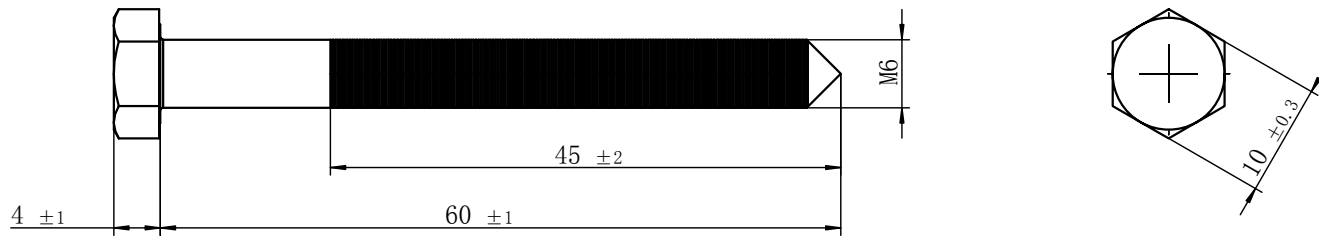

DIMENSIONS ARE IN mm TOLERANCES FRACTIONAL \pm ANGULAR: MACH \pm BEND \pm ONE PLACE DECIMAL \pm TWO PLACE DECIMAL \pm		NAME	DATE	Richelieu Hardware		
	DRAWN					RICHELIEU /VENDOR ITEM NUMBER 246TYL20390
	CHECKED					
	ENG APPR.					
	MFG APPR.					
	Q.A.			SIZE	DWG.NO.	REV.
MATERIAL: Steel	COMMENTS:			A	Screw	0
FINISH: Black	1-4			DO NOT SCALE DRAWING		SHEET 1 OF 1
WEIGHT(GR): 15.26						