

Instruction Manual Revolving Shoe-Storage System Model No. DVXZXJ0800A-E

To Installer : Make sure to pass this instruction manual to customers after installation.

- To ensure correct use, please read the “Precautions for Use” and the integrated “Instructions for Use” for the Revolving Shoe-Storage System.

To ensure operational safety, be sure to read the “Safety Precautions” before use.

Please retain these instructions after use for easy reference when needed.

Safety Precautions

Be sure to observe the following precautions.

To reduce the risk of injury, loss of life, electric shock, fire, malfunction, and damage to equipment or property, always observe the following safety precautions.

Explanation of symbols

- The following symbols are used to classify and describe the level of hazard, injury, and property damage caused when the denotation is disregarded and improper use is performed.



CAUTION

Denotes a hazard that could result in minor injury.



- The following symbols are used to classify and describe the type of instructions to be observed.



This symbol is used to alert users to a specific operating procedure that must not be performed.



CAUTION

 Prohibited	<ul style="list-style-type: none"> ● Do not apply excessive force or place heavy object on shelves or rails. The product revolves 180 degrees only. The stored objects could fall and injure you. 	
 Prohibited	<ul style="list-style-type: none"> ● Do not spin the Revolving Shoe-Storage System too quickly.  <p>You could get your fingers caught, or stored objects could fall and injure you.</p>	 Prohibited
		<ul style="list-style-type: none"> ● Do not enter the cabinet or hang on the shelves or any part of the Revolving Shoe-Storage System.  <p>You could get caught by the Product and be injured.</p>

Precautions for Use

- **The Revolving Shoe-Storage System is designed for the storage of shoes only. Do not store any other objects in the Product.**

The Product could be damaged and stored objects could fall and injure you.



- **Be sure to return the Product into the cabinet after use.**

You may bump into the rack and be injured if you do not stow it.

Precautions for Use

- Do not place wet shoes on shelves of the Revolving Shoe-Storage System.

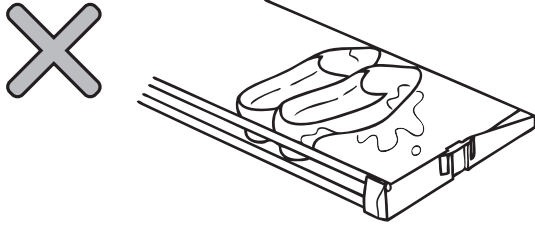

The Product could rust or warp resulting in Product damage or failure.

- Make sure shoes are placed firmly on the shelf. Do not operate the Product if shoes have fallen or are not secure on shelves.

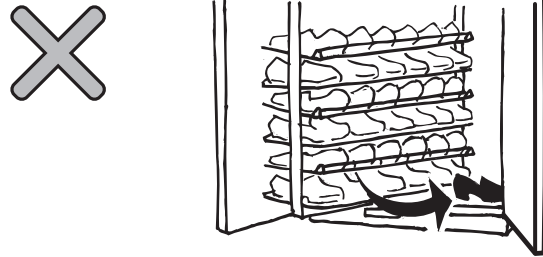

The shoe or the Revolving-Shoe Storage could be damaged.

- If there is existing space at the rear side of the Revolving-Shoe Storage System, do not store shoes or any other items in the rear space.

This may result in damage to shoes or the Product.

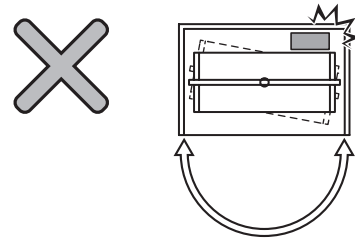

- The recommended maximum storage weight (even load) per shelf is about 2 kg. Do not store shoes above the recommended weight.

Store shoes in an even manner.

The recommended maximum storage weight of about 2Kg is based on even weight distribution and should be used only as a guideline. Too much, or uneven weight distribution may cause the shelf to shift or warp and/or cause the Product to fail.

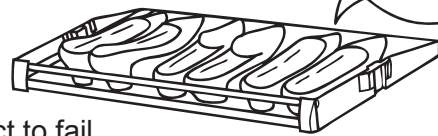

Instructions for Use

1. Fully open the doors.

(The Product or doors could be damaged if not fully opened.)

2. Rotate the Product SLOWLY holding the handle.

(Stored objects could fall and injure you if operated suddenly.)

3. Motion of the Product.

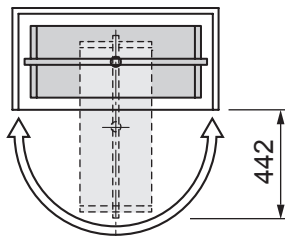

The Product rotates to 180°

- Do not apply excess force.
- Do not apply excess force in the wrong rotation direction.
- Be sure to operate with the handle.

[Installation or use of any parts other than those included with the original unit may result in injury or failure of Product.]



[Operate in reversed direction while pulling out 442mm toward you as maximum clarification required but this may differ depending on the size of cabinet you purchased.]

CAUTION

Keep hands and fingers away from moving parts to make sure they are not pinched during operation of the Revolving Shoe-Storage System.

4. How to Place Shoes on Shelves.

- Put shoes in the vertical direction.

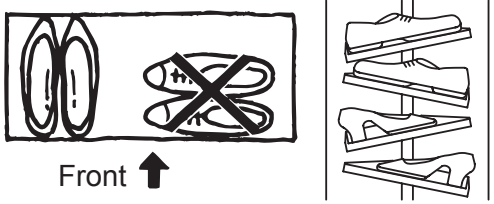

CAUTION

Do not pile shoes on the shelves.

(Shoes could fall off a shelf during operation which can cause damage to the shoes and the Product.)



5. Rough Indication of Shoes Storage Size and Adjustment with Shelf Board on Shelves.

Initial setting of shelves is based on 14 shelves, assuming the lower 8 shelves for women's shoes and the upper 6 shelves for men's shoes.

Initial Setting of Shelves

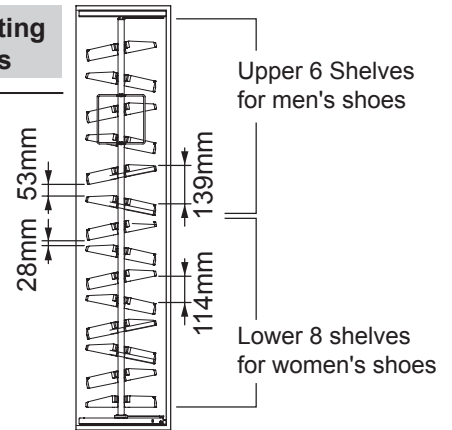

- Shoe storage capacity may differ depending on various conditions such as shoe size, type and design, in addition to the depth dimension (D) of the cabinet purchased.
- Adjust each shelf to accommodate the shoe size and type to be stored.
※ Mounting height position of each shelf is adjustable at 25mm intervals.

Example of Shoe Storage Capacity by Size

Case of Cabinet Depth Dimension Minimum, D = 365mm

Case of Cabinet Depth Dimension Minimum, D = 365mm or more

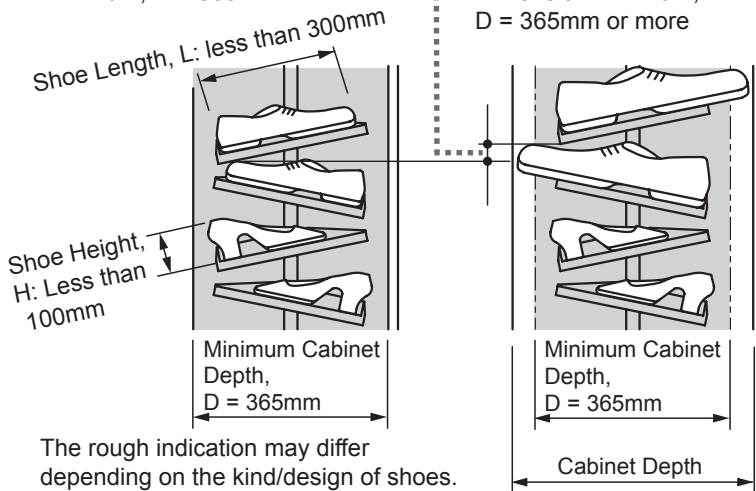

Example

- Storage capacity may differ depending on various conditions such as type, size, and design of shoes in addition to the cabinet depth (D).

Heel (H1), Foot Dorsum (H2), Toe (H3), Heel Position (L2), etc.

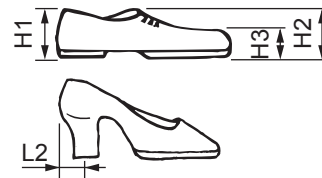

6. How to Remove Shelves.

Slightly lift the shelf and pull it toward you.

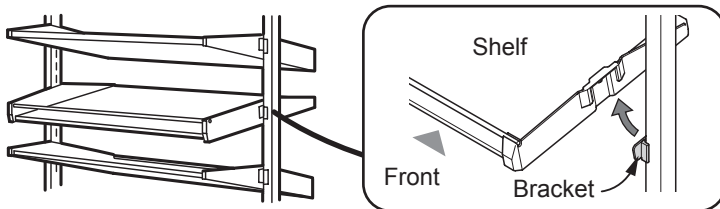

CAUTION

Alternate position of the Fall Prevention Bar (back to front) for each consecutive lower shelf.

* Mount the shelf in a reverse procedure of the removal procedure.

Care

- Wipe off dirt on the surface with soft cloth soaked in solution of neutral kitchen detergent and well squeezed. Then, wipe the surface with a dry, soft cloth.

CAUTION

Do not wipe the surface with any type of abrasive or harsh cleaner such as alcohol, benzine, paint thinner or powdered cleanser.

