



DOMUS LINE  
L I G H T S T Y L E



DOMUS LINE Srl  
Via Maestri del Lavoro, 1  
33080 PORCIA \_ PN \_ Italy

phone 0039 0434 595911  
fax 0039 0434 923345  
e-mail [info@domusline.com](mailto:info@domusline.com)  
website [www.domusline.com](http://www.domusline.com)

## X-DRIVER D-MOTION

INSTALLATION MANUAL	EN
INSTALLATIONSHANDBUCH	DE
MANUEL D'INSTALLATION	FR
MANUAL DE INSTALACIÓN	ES
MANUALE DI INSTALLAZIONE E USO	IT

Ref. 3491000\_r6



Device in insulation class II. Connection to the earthing circuit is not necessary.

*Gerät der Isolierklasse II. Der Anschluss an einen geerdeten Kreislauf ist hier nicht notwendig.*

*Luminaire de classe II (isolation). Raccordement au circuit de mise à la terre non indispensable.*

*Aparato en clase de aislamiento II. No es necesaria la conexión al circuito de tierra.*

*Apparecchio in classe d'isolamento II. Non è necessaria la connessione al circuito di messa a terra.*



*Lamp power supply unit thermally protected at 110°C*

*Thermisch geschützten Lampe Netzgeräte bis 110°C*

*Alimentation de la lampe protégée thermiquement à 110°C.*

*Unidades de potencia de la lámpara de protección térmica a 110°C*

*Unità di alimentazione lampada protetta termicamente a 110°C.*



*Independent transformer specially designed to be installed "visible" (it can be used without the supplementary protective case and without being integrated into lights).*

*LED-Transformator für selbstständigen Einsatz bei "sichtbaren" Installationen (auch ohne zusätzliche Schutzhülle und ohne Einbau in Beleuchtungen einsetzbar).*

*Transformateur indépendant spécifique pour installations "à vue" (peut être utilisé sans bache de protection supplémentaire et sans être incorporé dans des appareils d'éclairage).*

*Transformador independiente, específico para instalaciones a la vista (se puede utilizar sin carcasa adicional de protección y sin incorporarlo a aparatos de iluminación).*

*Trasformatore per uso indipendente specifico per installazioni "a vista" (può essere utilizzato senza involucro supplementare di protezione e senza essere incorporato in apparecchi di illuminazione).*

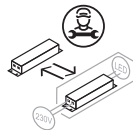
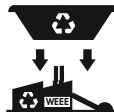
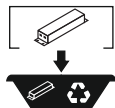
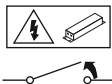



**SELV**  
EQUIVALENT

*This symbol indicates that the transformer complies with the European EN 61347-1 standard. The SELV symbol (Safety Extra Low Voltage) identifies a transformer in which touching the secondary circuit outputs, even if no lamps are connected, does not constitute a hazard.*

Dieses Symbol zeigt an, dass der Transformator mit der Europäischen EN 61347-1 Standard entspricht. Das SELV-Symbol (Safety Extra Low Voltage) identifiziert einen Transformator, bei dem Berühren der Sekundärkreis-Ausgänge auch wenn keine Leuchten angeschlossen sind, keine Gefahr darstellen.

*Il indique que le transformateur est conforme au normatif Européen EN 61347-1. Le symbole SELV (Safety Extra Low Voltage - Basse tension de sûreté) identifie un appareil en qui, aussi en service au vide (c'est-à-dire sans lampes relié), il est possible de toucher la sortie du secondaire sans quelques-uns danger.*

Indica que el transformador está conforme a la normativa europeo EN 613147-1. El símbolo SELV (Safety Extra Low Voltage - Baja tensión de seguridad), identifica un aparato en el que, también en servicio a vacío (es decir sin lámparas unidas), es posible tocar la salida de lo secundario sin ningún peligro

Indica che il trasformatore è conforme alla normativa Europea EN 613147-1.

*Il simbolo SELV (Safety Extra Low Voltage - Bassissima tensione di sicurezza) identifica un apparecchio nel quale, anche in servizio a vuoto (cioè senza lampade collegate), è possibile toccare l'uscita del secondario senza alcun pericolo.*

*The product must be disposed of separately from urban waste, delivering it to the collection centres established by the prevailing standard. Adequate sorted waste collection contributes to preventing negative effects on the environment and health and favours reuse and/or recycling materials. Incorrect disposal of the product implies the application of the administrative sanctions envisaged by the prevailing regulation.*

Die Leuchte muss getrennt vom Hausmüll entsorgt und entsprechend der geltenden Richtlinien, an den vorgesehenen Sammelstellen abgegeben werden. Die angemessene getrennte Sammlung trägt dazu bei, eventuelle negative Auswirkungen auf die Umwelt und die Gesundheit zu vermeiden und die Wiederverwendung und/oder das Recycling der Materialien zu begünstigen. Die unsachgemäße Entsorgung bringt die Anwendung administrativer Strafen mit sich, die in den geltenden Richtlinien vorgesehen sind.

*Le produit doit être collecté séparément et non jeté avec les déchets ménagers en le portant dans les déchetteries prévues par la réglementation en vigueur. Un tri sélectif approprié contribue à éviter des possibles effets négatifs sur l'environnement et sur la santé et favorise la réutilisation et/ou le recyclage des matériaux. L'élimination abusive entraîne l'application des sanctions administratives prévues par la réglementation en vigueur.*

Se debe desechar el producto de forma separada de los residuos urbanos; se lo debe entregar en los centros de recolección previstos por la norma en vigor. La recolección diferenciada adecuada contribuye a evitar posibles efectos negativos en el medioambiente y en la salud y favorece la reutilización y/o el reciclaje de los materiales. Si se lo desecha en forma abusiva tendrá como consecuencia la aplicación de sanciones administrativas previstas por la normativa vigente.













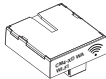
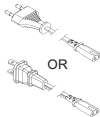

*Il prodotto deve essere smaltito separatamente dai rifiuti urbani consegnandolo ai centri di raccolta previsti dalla normativa in vigore. L'adeguata raccolta differenziata contribuisce ad evitare possibili effetti negativi sull'ambiente e sulla salute e favorisce il reimpiego e/o il riciclo dei materiali. Lo smaltimento abusivo comporta l'applicazione delle sanzioni amministrative previste dalla normativa vigente.*



## Specifications

	X-DRIVER D-MOTION 30Watt	X-DRIVER D-MOTION 60Watt	X-DRIVER D-MOTION 96Watt
Input voltage	100-120VAC,220-240Vac (100-120VAC for North America only)		
Input frequency	50/60Hz		
Input current	0,40A for 100-120Vac 0,20A for 220-240Vac	0,80A for 100-120Vac 0,35A for 220-240Vac	0,90A for 100-120Vac 0,45A for 220-240Vac
Output voltage	24Vdc	24Vdc	24Vdc
Rated output power	0-30W	0-60W	0-96W
Dimming range	2%-100%		
Operation mode	PWM+PFM		
Ambient temperature	-20...+40°C (For Europe Only)		
IP protection	IP20		
The LED Power Supply meets the harmonic emissions requirements of ANSIC82.77-10(For CUL only)			

### Optional Accessories Table

Type	MODULE CM2-XDM		MODULE CM3-XDM	MODULE CM4-XDM	Input Cable	
Picture						
RADIO RECEIVER FOR LIGHTING CONTROL	Radio receiver for lighting control Model : CM2-XDM RECEIVER CONTROLLER IC: 26690-CM2 FCC ID: 2AX76-CM2		Radio receiver for lighting control Model : CM3-XDM RECEIVER CONTROLLER IC: 26690-CM3 FCC ID: 2AX76-CM3	Radio receiver for lighting control Model : CM4-XDM RECEIVER CONTROLLER IC: 26690-CM4 FCC ID: 2AX76-CM4	-	
Function Characteristics	IR/PIR	IR/PIR/2.4G		IR/PIR/BT	ONLY APP	-
Functional Fittings	  	  Call-ME V17 TW  RC1-TW  		    APP 	APP 	-

# INSTRUCTION MANUAL

SERIES: X-DRIVER D-MOTION 30-60Watt

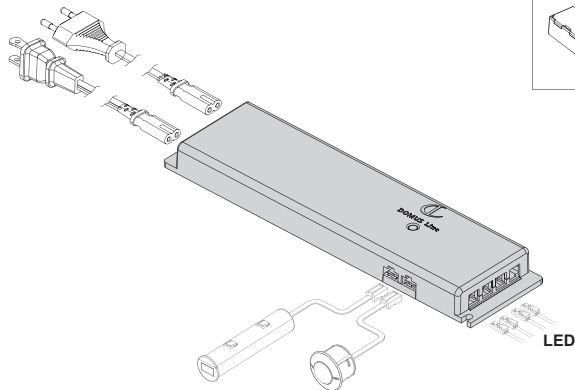

CM2-XDM

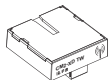

CM3-XDM

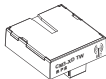

CM4-XDM

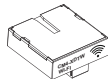

## Module Installation

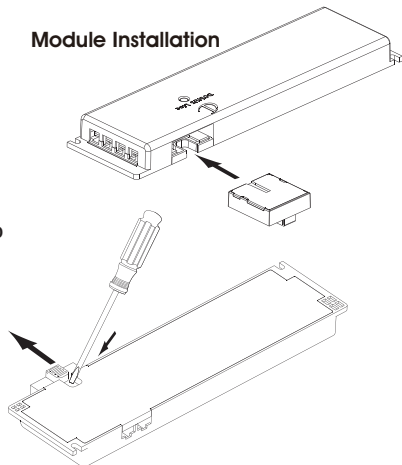

IR XD

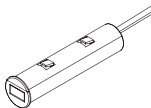

PIR XD

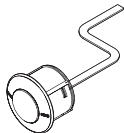

## IR-XD LSW

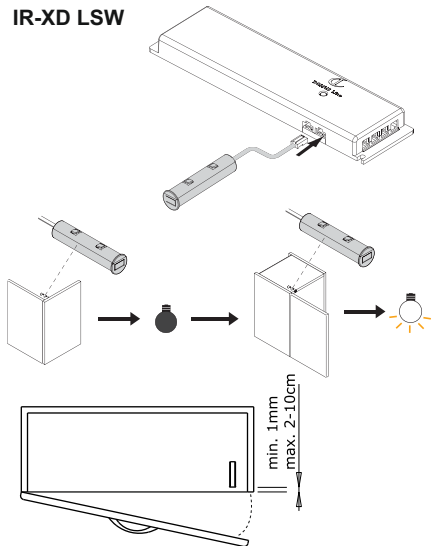

Material	Finish	H max.	H min.
laminate	dark oak	20-30mm	1mm
varnished	bright white	80-100mm	1mm
wood	natural	60-80mm	1mm

## IR-XD DSW

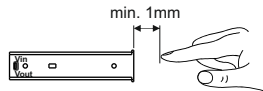
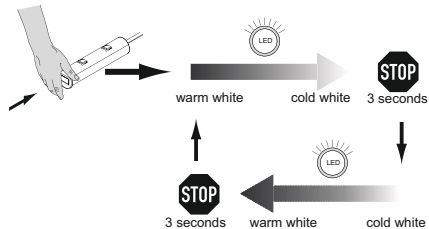
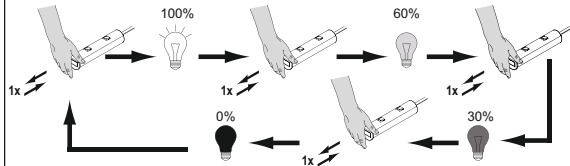

# PIR XD

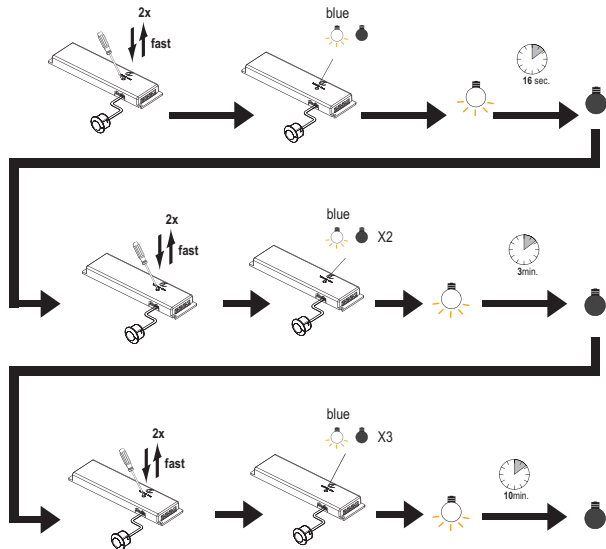
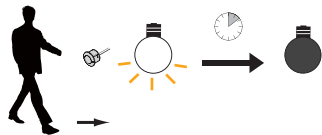
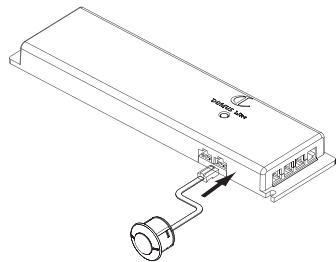



## Remote Control matched transmitter

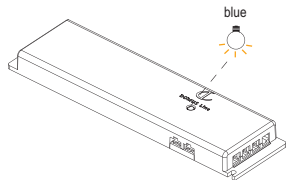
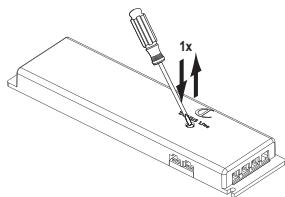

RC3-TW

Channel I  
Channel II  
Channel III

5 sec.

STOP

blue blue

For detail instruction please see the manual of Remote controller 3 channels.  
Max.number of controllers connected for one smart driver: 7pcs

Remote controller  
RC1 TW

5 sec.

STOP

blue blue

For detail instruction please see the manual of Remote controller dimmer  
Max.number of controllers connected for one smart driver: 7pcs

Remote controller  
dimmer CALL-ME  
V17 TW

1 sec.

2x

blue blue

For detail instruction please see the manual of Remote controller CALL-ME V17  
Max.number of controllers connected for one smart driver: 7pcs

## Reset matched transmitter

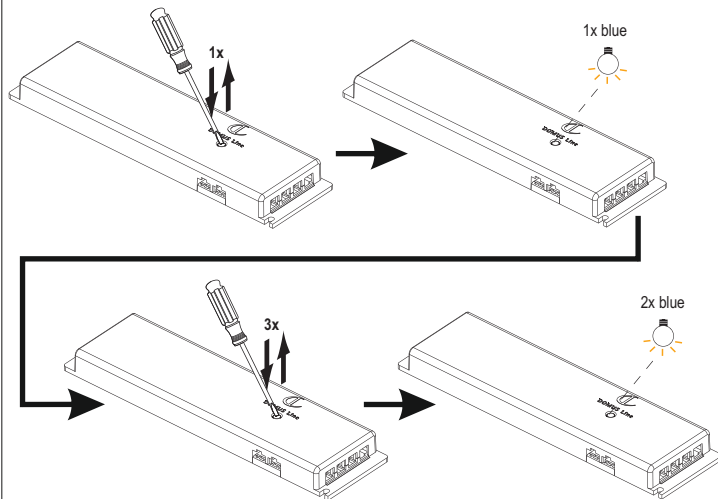

Call-ME V17 TW



RC1-TW



RC3-TW



## Remote control Function

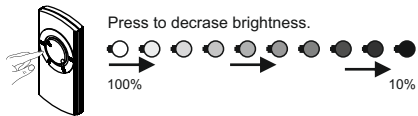
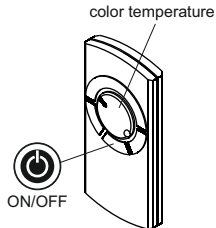

For detail instruction please see the manual of Remote controller dimmer

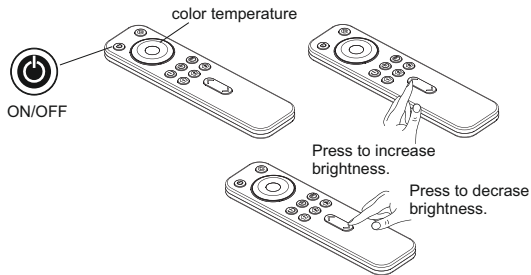

For detail instruction please see the manual of Remote controller 3 channels

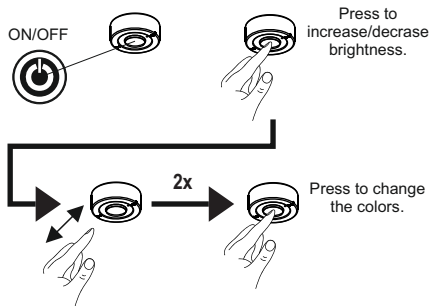

For detail instruction please see the manual of Remote controller V17

## PIR WI XD Function

### X-Driver set up example

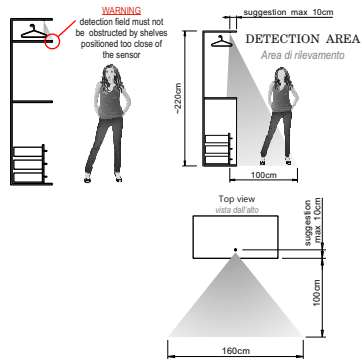
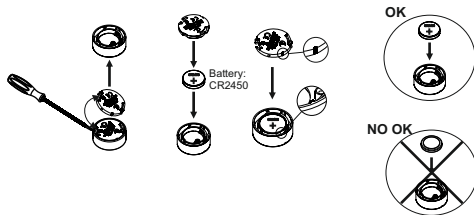
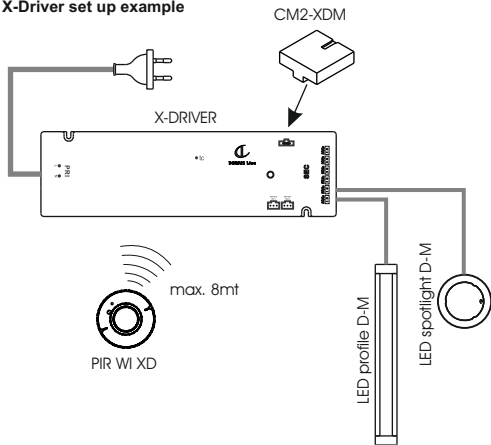

For detail instruction please see the manual of PIR WI XD

## IR WI XD Function

Battery:  
CR2450

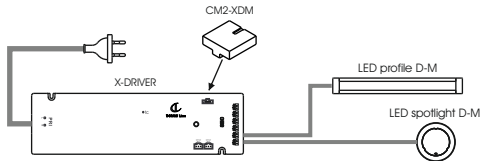
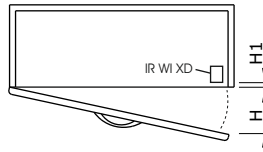
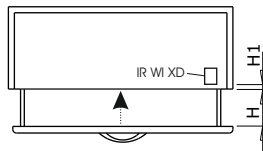
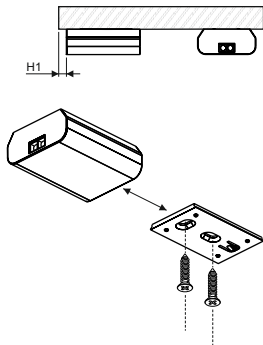
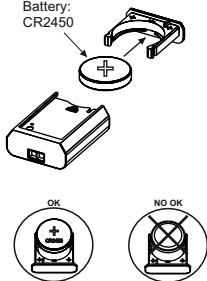

Material	Finish	H max.	H1
laminate	dark oak	80-100mm	20mm
varnished	bright white	140-160mm	3mm
wood	natural	160-180mm	3mm
glass	extra light serigraphy	80-100mm	20mm
glass	matt	100-120mm	3mm
aluminium	brown	80-100mm	20mm

For detail instruction please see the manual of IR WI XD

## App. DOMUS 4U



Scan to download APP



Enter to the APP, press Info and read the instructions.

**DOMUS 4U can control max. 5 X-DRIVER**

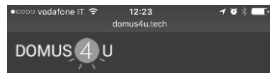

### SEARCH FOR DEVICES

With the **DOMUS4U** application that uses the LE Bluetooth technology of your device to search for all the **Domus Line X-DRIVER** devices in your home, you can **switch on, switch off or adjust the brightness or light colour** of the devices connected to it with just a simple touch.

After selecting the devices, you will be able to store them and rename them however you like (for example, Kitchen lights, Bathroom lights, and so forth).

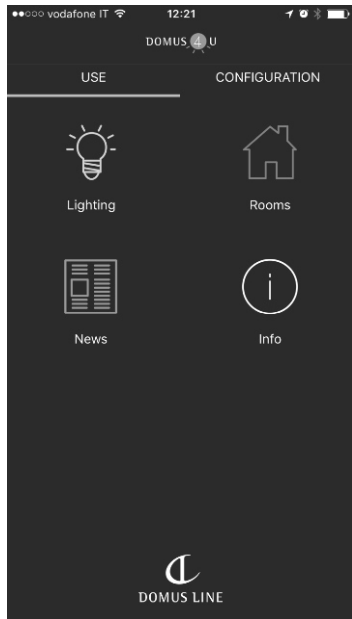



**DOMUS 4U WI-FI**  
APP COMPATIBLE WITH X-DRIVER AND  
CM4-XD TI MANAGE LIGHTS FROM  
SMARTPHONES

**DOWNLOAD THE APP:**



<http://bit.ly/domus4uwifi>



<http://bit.ly/domus4uwifigoogleplay>

**WARNING:**

Safety is guaranteed if these instructions are followed and therefore they must be kept. Installation may require the involvement of qualified personnel. Before proceeding with installation of the device ensure that the environmental conditions are in compliance with and suitable for the product characteristics. Before any operation on the device disconnect mains power.

**INTRODUCTION:**

Power supply is designed exclusively for LED lamps. It can be used together with control modules, IR / PIR sensors, remote control remote controls and APP (see optional table accessories).

The built-in protection circuit turns off the power supply when there is a short circuit, overload or overheating.

**X-DRIVER D-M** restarts automatically after the problem has been resolved.

**WARRANTY:**

The warranty on the device is valid only if powered by a power supply provided by DOMUS Line. The warranty's general terms and conditions for this device are available at [www.domusline.com](http://www.domusline.com)

This device complies with part 15 of the FCC Rules. Operation is subject to the following two conditions: (1) This device may not cause harmful interference, and (2) this device must accept any interference received, including interference that may cause undesired operation.

**FCC warning:**

Any Changes or modifications not expressly approved by the party responsible for compliance could void the user's authority to operate the equipment.

**Note:** This equipment has been tested and found to comply with the limits for a Class B digital device, pursuant to part 15 of the FCC Rules. These limits are designed to provide reasonable protection against harmful interference in a residential installation. This equipment generates uses and can radiate radio frequency energy and, if not installed and used in accordance with the instructions, may cause harmful interference to radio communications. However, there is no guarantee that interference will not occur in a particular installation. If this equipment does cause harmful interference to radio or television reception, which can be determined by turning the equipment off and on, the user is encouraged to try to correct the interference by one or more of the following measures:

- Reorient or relocate the receiving antenna.
- Increase the separation between the equipment and receiver.
- Connect the equipment into an outlet on a circuit different from that to which the receiver is connected.
- Consult the dealer or an experienced radio/TV technician for help.

**IC warning**

This device complies with Industry Canada licence-exempt RSS standard(s). Operation is subject to the following two conditions: (1) This device may not cause interference, and (2) This device must accept any interference, including interference that may cause undesired operation of the device.

This equipment complies with FCC radiation exposure limits set forth for an uncontrolled environment. This equipment should be installed and operated with minimum distance 20cm between the radiator & your body.



**HINWEIS:**

Die Sicherheit wird nur gewährleistet, wenn diese Anweisungen befolgt werden. Sie sind daher aufzubewahren. Für die Montage kann qualifiziertes Personal erforderlich sein. Vor der Montage der Leuchte sicherstellen, dass die Umgebungsbedingungen konform und geeignet für die Produktmerkmale sind. Vor jeder Arbeit an Leuchten, die Netzspannung trennen.

**WICHTIG:**

Die Stromversorgung ist ausschließlich für LED-Lampen ausgelegt. Es kann zusammen mit Steuermodulen, IR / PIR-Sensoren, Fernbedienungen und APP (siehe optionales Zubehör) verwendet werden. Die eingebaute Schutzschaltung schaltet die Stromversorgung bei Kurzschluss, Überlast oder Überhitzung ab. **X-DRIVER D-M** startet automatisch neu, nachdem das Problem behoben wurde.

**GARANTIE:**

Die Garantie auf die Leuchte ist nur gültig, wenn es mit einem Konverter der Firma DOMUS Line gespeist wird. Die allgemeinen Garantiebedingungen der Leuchten und Konverter stehen auf [www.domusline.com](http://www.domusline.com) zur Verfügung

**MISE EN GARDE:**

Il est important pour la sécurité des personnes de suivre ces instructions et de les conserver. L'installation peut exiger la participation de personnel qualifié. Avant de procéder à l'installation de l'appareil veiller à ce que les conditions environnementales soient conformes et appropriées aux caractéristiques du produit. Avant toute intervention sur l'appareil, couper la tension du secteur.

**INTRODUCTION:**

L'alimentation est conçue exclusivement pour les lampes LED. Il peut être utilisé avec les modules de commande, les capteurs IR / PIR, les télécommandes à distance et l'APP (voir accessoires de table en option). Le circuit de protection intégré coupe l'alimentation en cas de court-circuit, de surcharge ou de surchauffe.

**X-DRIVER D-M** redémarre automatiquement une fois le problème résolu.

**GARANTIE:**

La garantie de cet appareil est valable uniquement si ce dernier est alimenté par un transformateur fourni par DOMUS Line. Les conditions générales de garantie de cet appareil sont disponibles sur le site [www.domusline.com](http://www.domusline.com)

**IC warning**

Le présent appareil est conforme aux CNR d'Industrie Canada applicables aux appareils radio exempts de licence. L'exploitation est autorisée aux deux conditions suivantes:

- (1) l'appareil ne doit pas produire de brouillage, et
- (2) l'utilisateur de l'appareil doit accepter tout brouillage radioélectrique subi, même si le brouillage est susceptible d'en compromettre le fonctionnement.

**ATENCIÓN:**

La seguridad está garantizada si se siguen éstas instrucciones. La instalación puede requerir la participación de personal cualificado. Antes de proceder con la instalación del dispositivo, asegúrese de que las condiciones ambientales son las adecuadas para el producto. Antes de cualquier operación hay que comprobar que la red eléctrica esté desconectada.

**PREÁMBULO:**

La fuente de alimentación está diseñada exclusivamente para lámparas LED. Se puede usar junto con módulos de control, sensores IR / PIR, controles remotos de control remoto y APP (ver accesorios de mesa opcionales). El circuito incorporado apaga la fuente de alimentación cuando hay un cortocircuito, sobrecarga o sobrecalentamiento.

**X-DRIVER D-M** se reinicia automáticamente después de que se haya resuelto el problema.

**GARANTÍA:**

La garantía del aparato es válida solamente si se lo alimenta con un alimentador proporcionado por DOMUS Line. Las condiciones generales de garantía de este aparato están a disposición en

[www.domusline.com](http://www.domusline.com)

**AVVERTENZA**

La sicurezza è garantita se si seguono queste istruzioni e pertanto è necessario conservarle. L'installazione può richiedere il coinvolgimento di personale qualificato. Prima di procedere all'installazione dell'apparecchio assicurarsi che le condizioni ambientali siano conformi e idonee alle caratteristiche del prodotto. Prima di ogni operazione sull'apparecchio, disinserire la tensione di rete.

**PREMESSA:**

L'alimentatore è progettato esclusivamente per lampade a LED. Può essere usato insieme ai moduli di controllo, IR / sensori PIR, radiocomandi a distanza e APP (dettagli vedere accessori opzionali tabella). Il circuito di protezione incorporato spegne l'alimentatore in caso di: corto circuito, sovraccarico o sovratemperatura.

**X-DRIVER D-M** si riavvia automaticamente dopo la sistemazione del problema riscontrato.

**GARANZIA**

Le condizioni generali di garanzia di questo apparecchio sono disponibili sul sito [www.domusline.com](http://www.domusline.com)