

Fitting for top-running wooden doors up to 100 kg (220 lbs.), with surface mounted running track or running track flush with the ceiling. Sound attenuation. Ceiling mounting. Wall pocket solution.

Product highlights



Comfort Outstanding living comfort thanks to effective exclusion of sound, drafts, odors and unwanted light incidence



Productivity Easy height adjustment via both suspensions and convenient depth adjustment of the installed door in the wall pocket

Technical specifications



Max. 100 kg (220 lbs.)



Max. 2500 mm (8' 2 7/16")



750–1250 mm (2' 5 17/32" to 4' 1 7/32")
Inside clearance (LMB)



44–50 mm (1 23/32" to 1 31/32")

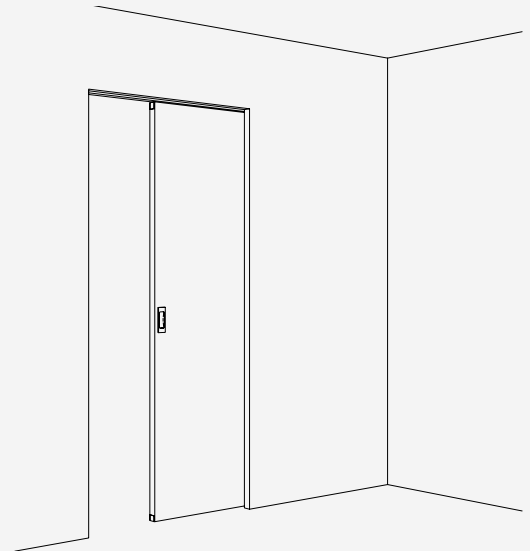

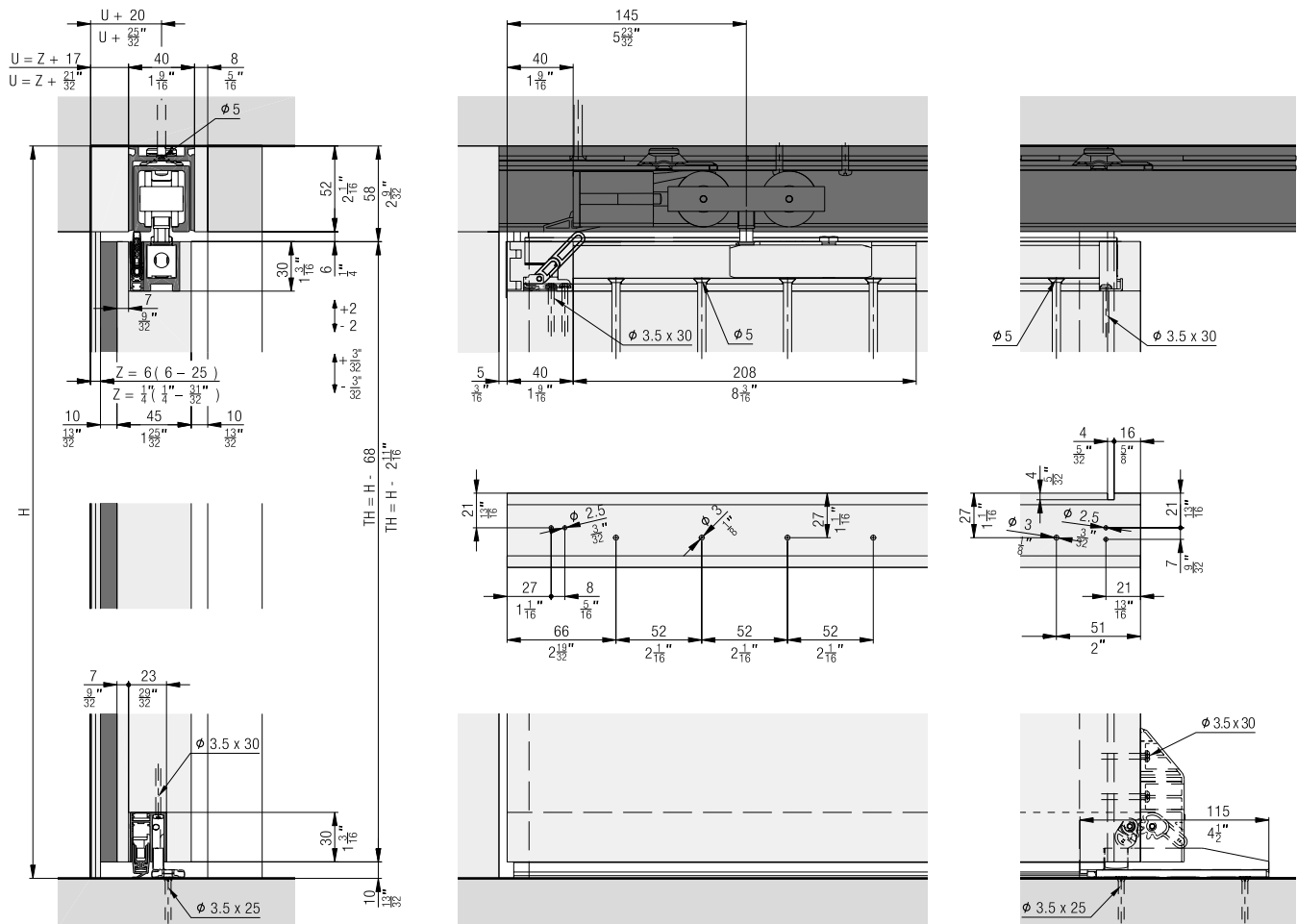

Installation examples



Set for 1 wooden door up to 100 kg (220 lbs.)

	No.
Hawa Junior 100 B/B Pocket Acoustics, for 1 door	30427

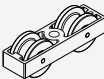
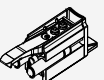
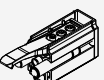
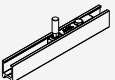
Set consisting of:

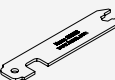
		30427	No.
	Running gear, 2-wheeled, M10, ball bearing	2	30137
	SoftStop Hawa Junior 100 Acoustics, with ramp and adjustable retention spring	1	30132
	SoftStop Hawa Junior 80/100, with adjustable retention spring	1	27771
	Suspension profile, plate with screw M10	2	30379
	Cover cap set, plastic, aluminum look, 4-piece set	1	30483
	Locking wrench to suspension	1	10778

Accessories for set

	No.
 Spring loaded stopper Hawa Junior 80/100	25370

Running tracks

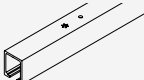

	mm (inch)	No.
	1,400 (4' 7 1/8 ")	10189
	1,600 (5' 3 ")	10190
	1,800 (5' 10 7/8 ")	10191
	2,000 (6' 6 3/4 ")	10192
	2,200 (7' 2 5/8 ")	10193
	2,500 (8' 2 7/16 ")	10194
	3,000 (9' 10 1/8 ")	18532
	cut to size	10188

Components for running tracks

	No.
 Running track fastening Hawa Junior 80/100, for removable running track, up to max. internal door width of 850 mm (2' 9 15/32 ")	25442

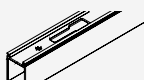

Assembly set, up to 2000 mm (6' 6 3/4")

	No.
Set for mountable and demountable running track	25207

	mm (inch)	25207	No.
Set consisting of:			
 Retainer profile with a bayonet lock, aluminum, anodized	2,035 (6' 8 1/8 ")	1	25212
 Small parts to retainer profile, 6-piece set		1	25520

Assembly set, up to 2500 mm (8' 2 7/16")

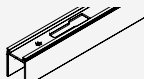

	No.
Set for mountable and demountable running track	25371

	mm (inch)	25371	No.
Set consisting of:			
 Retainer profile with a bayonet lock, aluminum, anodized	2,535 (8' 3 13/16 ")	1	25443
 Small parts to retainer profile, 7-piece set		1	25521

Assembly set, up to 3000 mm (9' 10 1/8")

	No.
Set for mountable and demountable running track	25441

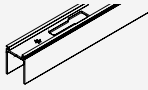
Set consisting of:

	mm (inch)	25441	No.
	3,035 (9'11 1/2")	1	25444
		1	25522

**Sets left type
(horizontal seal set)**

		No.
	Seal, Hawa Acoustics XS, left	30437
	Seal, Hawa Acoustics S, left	30439
	Seal, Hawa Acoustics M, left	30441
	Seal, Hawa Acoustics L, left	30443
	Seal, Hawa Acoustics XL, left	30445

**Sets right type
(horizontal seal set)**

		No.
	Seal, Hawa Acoustics XS, right	30436
	Seal, Hawa Acoustics S, right	30438
	Seal, Hawa Acoustics M, right	30440
	Seal, Hawa Acoustics L, right	30442
	Seal, Hawa Acoustics XL, right	30444

Vertical seal for seal set, left, right set type

		No.
	Seal vertical, Hawa Acoustics, 7700 mm (25' 3 5/32"), silicone, black	30300

Hawa Acoustics horizontal seal set consisting of:

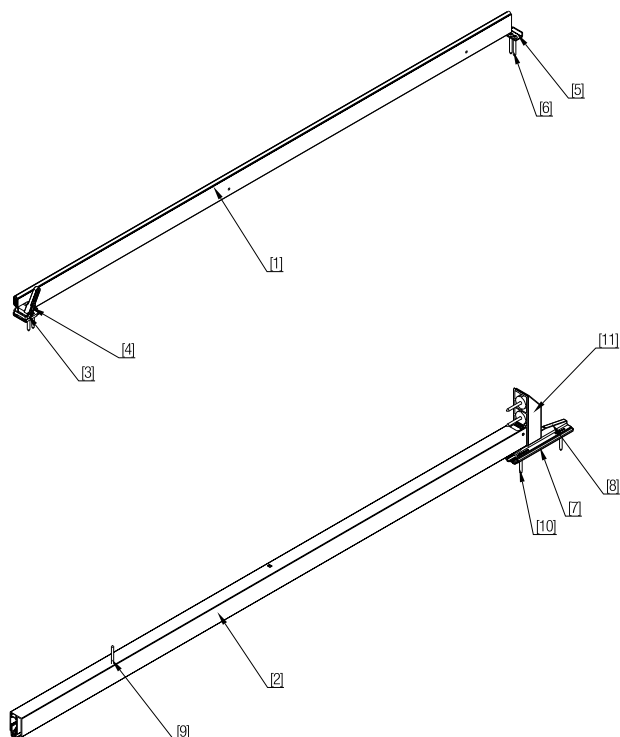

Position Position Position	Bezeichnung Designation Designation	Anzahl Numéro Number	Typ Type Type			
1	Hubdichtung Joint de levage Header seal	1	Links/Rechts Gauche/Droite Left/Right			
			XS	30454		
			S	30385		
			M	30455		
			L	30456		
2	Senkdichtung Joint d'abaissement Floor seal	1	Links Gauche Left		Rechts Droite Right	
			XS	30446	XS	30447
			S	30387	S	30383
			M	30448	M	30449
			L	30450	L	30451
3, 4, 5, 6	Kleinteileset oben Kit pour petites pièces, supérieur Small parts set top	1	Links Gauche Left		Rechts Droite Right	
			30390		30392	
			30416		30417	
			30418			
			30416		30417	
7, 8, 9, 10	Kleinteileset unten Kit pour petites pièces, inférieur Small parts set bottom	1	Links Gauche Left		Rechts Droite Right	
			30416		30417	
			30418			
			30416		30417	
			30418			
11	Pocketadapter Adaptateur pour caisson à galandage Pocket adapter	1	Links/Rechts Gauche/Droite Left/Right		30418	

Definition left, right / door width calculation

Left type (left hand lock)

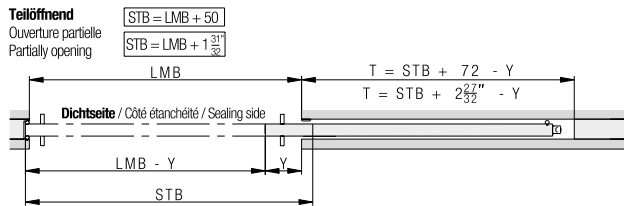
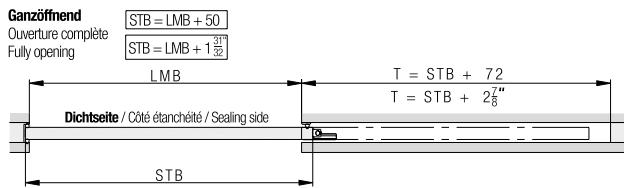

Right type (right hand lock)

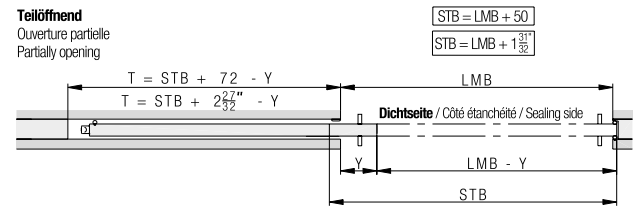
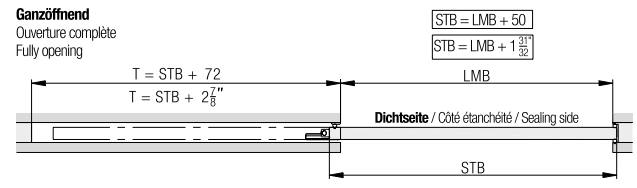

Acoustics set determination

	LMB
Hawa Acoustics XS	750 - 850
Hawa Acoustics S	850 - 970
Hawa Acoustics M	970 - 1100
Hawa Acoustics L	1100 - 1220
Hawa Acoustics XL	1220 - 1250

	LMB
Hawa Acoustics XS	2' 5 $\frac{17}{32}$ " - 2' 9 $\frac{151}{32}$ "
Hawa Acoustics S	2' 9 $\frac{19}{32}$ " - 3' 2 $\frac{164}{16}$ "
Hawa Acoustics M	3' 2 $\frac{31}{16}$ " - 3' 7 $\frac{169}{16}$ "
Hawa Acoustics L	3' 7 $\frac{5}{16}$ " - 4' $\frac{11}{32}$ "
Hawa Acoustics XL	4' $\frac{1}{32}$ " - 4' 1 $\frac{7}{32}$ "

Further installation examples

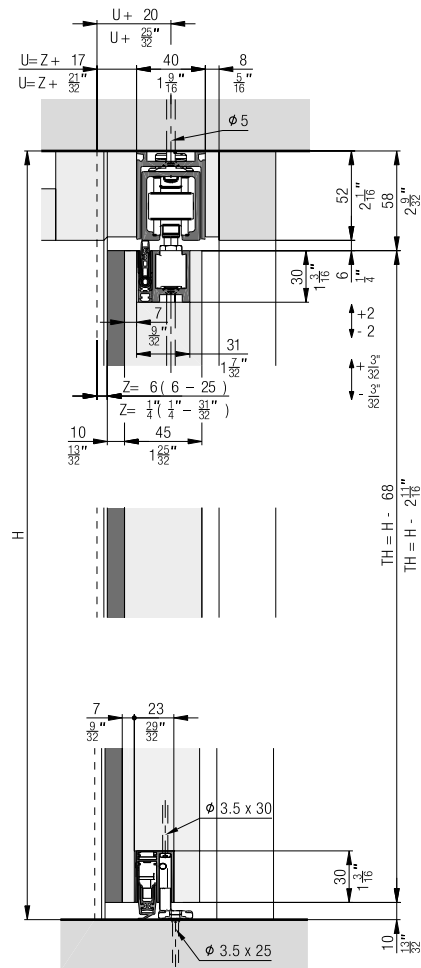

Pocket side view, assembly set

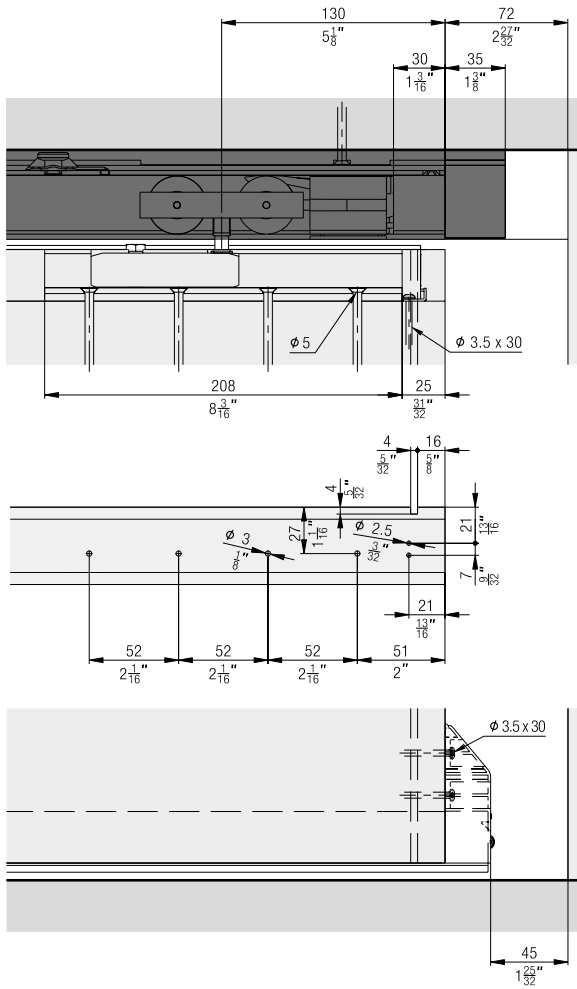

Pocket side view, spring buffer

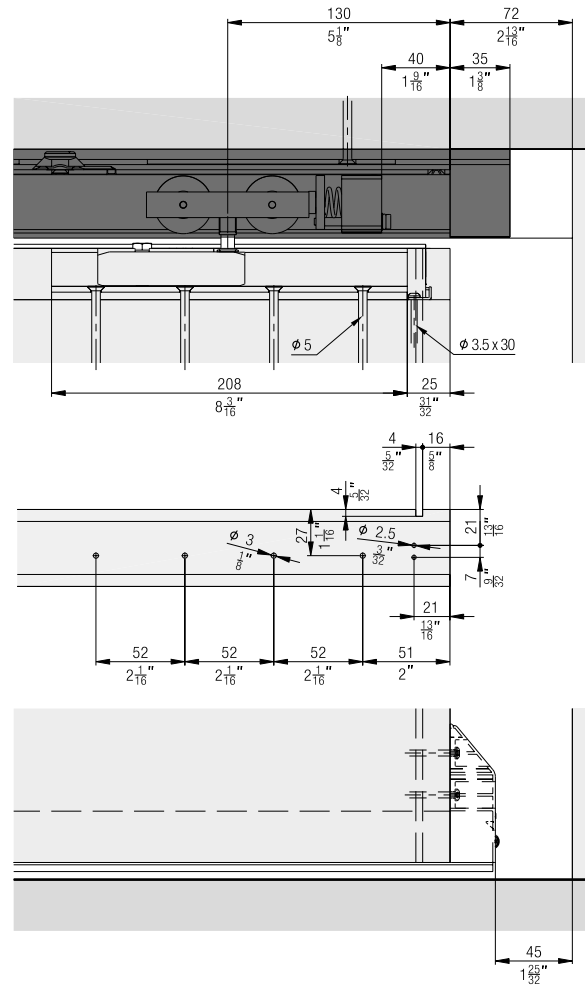

Details of end post at lock side

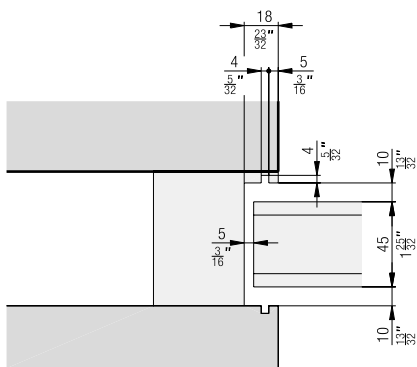

Calculations of running track length

The length of the running track must be shorter than the diagonal clearance (P2) by at least 80 mm (3 5/32").

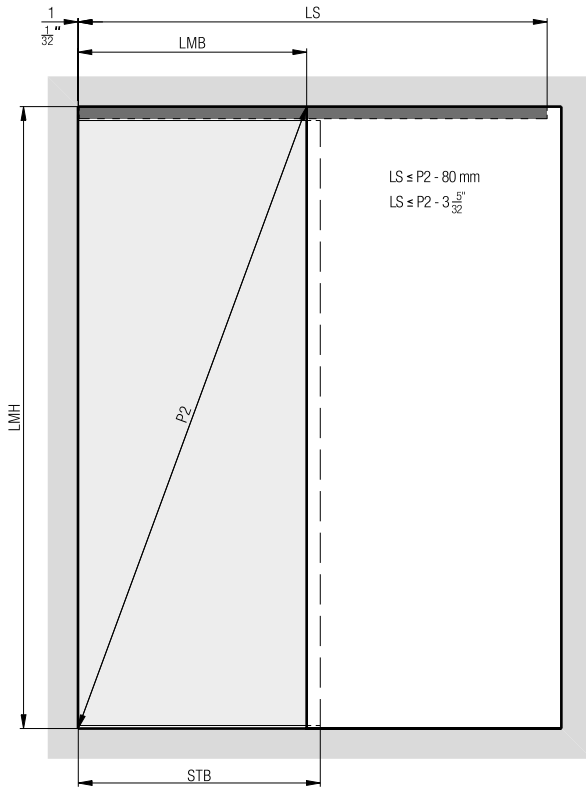

- LMB = inside clearance
- LMH = inside height
- STB = sliding door width
- P2 = diagonal clearance
- LS = running track

Variant with normal running track and running track fastening (25442)

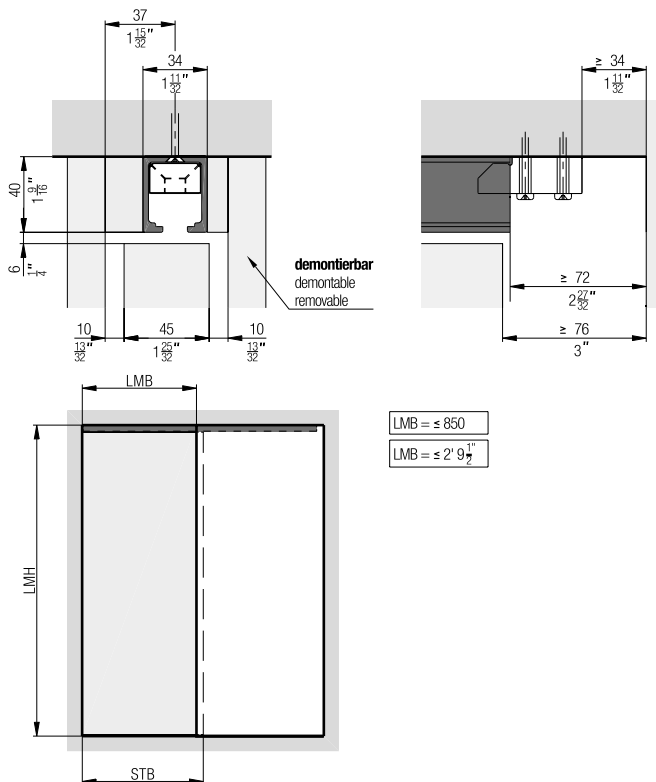

Bottom guide assembly detail

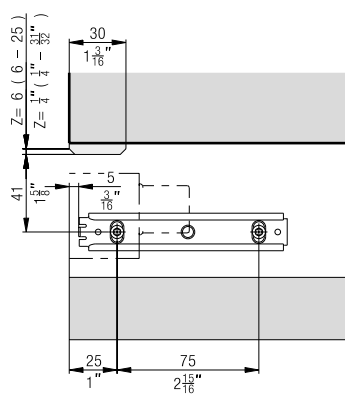

Room-to-room sound attenuation

All reference values have been measured on the basis of a practical design. The Rw sound attenuation values specify the expected sound attenuation between the two rooms which are influenced by the wall, the system and the choice of door leaf.

Reference values tested with a lightweight construction wall in accordance with James Hardy (type 1 H 31 / Rw 52 dB), size 2.5 x 2.45 m in accordance with DIN EN ISO 10140-2. Clearance 2.0 x 1.0 m. The sound attenuation relates to the entire structure and specifies which sound attenuation can be expected between the two rooms.

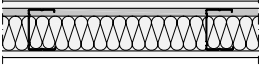
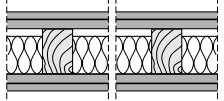
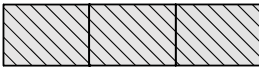
Example walls	System	Thickness of door leaf	Type of door leaf	Estimated sound attenuation effect
				Room to room Rw
Wall with minimum acoustic rating of Rw 52 dB Lightweight construction wall with metal stand  Lightweight construction wall with wooden stand  Solid wall  Acoustic ratings for wall construction according to manufacturer. The acoustic values may vary if installed in different wall types.	without Hawa Acoustics	39 mm	Single door leaf without sealing system	≈ 18 dB
	Hawa Porta 60 HMD Acoustics Hawa Porta 100 HMD Acoustics		Single door leaf, approx. 19 kg/m ² acoustic rating of Rw 29 dB	≈ 31 dB
			Chipboard, approx. 25 kg/m ² No defined acoustic rating	≈ 30 dB
	Hawa Junior 100 B Acoustics Hawa Porta 60 HMD Acoustics Hawa Porta 100 HMD Acoustics	44 mm	Door leaf with medium sound attenuation level approx. 25 kg/m ² , acoustic rating of Rw 39 dB	≈ 34 dB
			Single door leaf, approx. 20 kg/m ² acoustic rating of Rw 29 dB	≈ 30 dB
	Hawa Junior 100 B Acoustics	50 mm	Door leaf with medium sound attenuation level approx. 28 kg/m ² , acoustic rating of Rw 40 dB	≈ 34 dB
without Hawa Acoustics Hawa Porta 60 HMT Pocket Acoustics Hawa Porta 100 HMT Pocket Acoustics Hawa Junior 100 B Pocket Acoustics Hawa Porta 60 HMT Pocket Acoustics Hawa Porta 100 HMT Pocket Acoustics Hawa Junior 100 B Pocket Acoustics	without Hawa Acoustics	39 mm	Single door leaf without sealing system	≈ 20 dB
	Hawa Porta 60 HMT Pocket Acoustics Hawa Porta 100 HMT Pocket Acoustics		Single door leaf, approx. 19 kg/m ² , acoustic rating of Rw 29 dB	≈ 31 dB
			Door leaf with medium sound attenuation level approx. 25 kg/m ² , acoustic rating of Rw 39 dB	≈ 37 dB
	Hawa Junior 100 B Pocket Acoustics Hawa Porta 60 HMT Pocket Acoustics Hawa Porta 100 HMT Pocket Acoustics	44 mm	Single door leaf, approx. 20 kg/m ² acoustic rating of Rw 29 dB	≈ 32 dB
			Door leaf with medium sound attenuation level approx. 28 kg/m ² , acoustic rating of Rw 40 dB	≈ 39 dB
	Hawa Junior 100 B Pocket Acoustics	50 mm	Door leaf with high sound attenuation level approx. 33 kg/m ² , acoustic rating of Rw 42 dB	≈ 41 dB

Planning/execution

Further information about the product can be found on www.hawa.com.