

2 sliding + 1 stationary glass
 2 verre coulissant + 1 fixe
 2 vidrio corredizo + estacionario

2 + 1

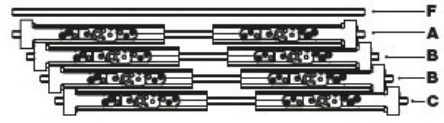

3 + 1



4 + 1

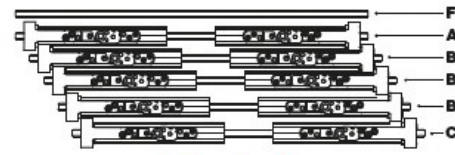

5 + 1

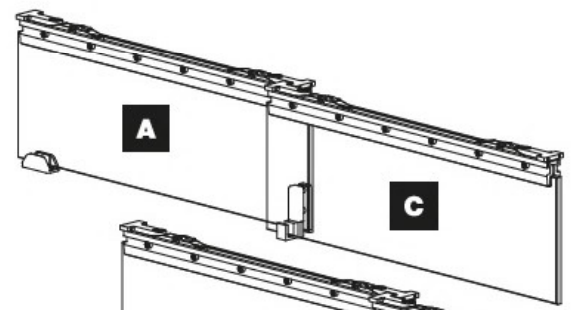

2 sliding glass
 2 verre coulissant
 2 vidrio corredizo

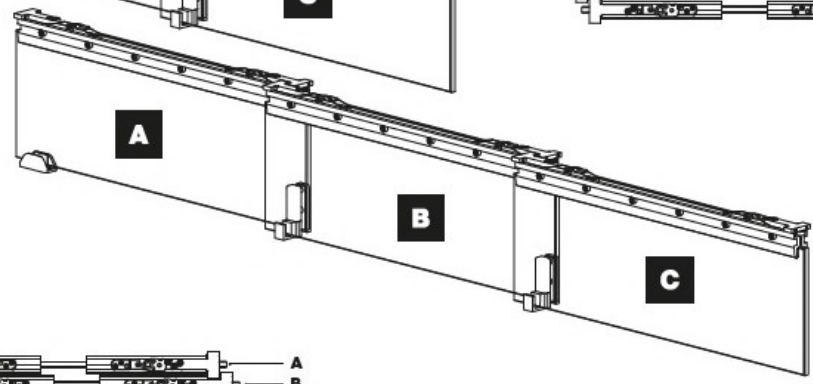

3 sliding glass
 3 verre coulissant
 2 vidrio corredizo

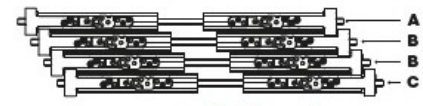
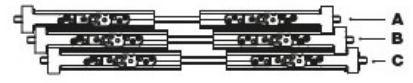

4 sliding glass
 4 verre coulissant
 4 vidrio corredizo

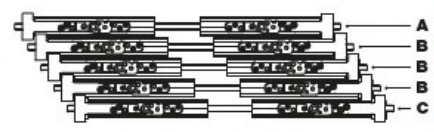

5 sliding glass
 5 verre coulissant
 5 vidrio corredizo