

Processing recommendation

EGGER Eurodekor and Eurodekor Plus boards

Machining of EGGER Eurodekor and Eurodekor Plus boards

Introduction

EGGER Eurodekor melamine resin-coated panels (in accordance with EN 14322) consist of wood-based materials that are covered on both sides with decorative paper. They are used in horizontal and vertical areas in furniture and interior design, for example for fronts, shelves, wardrobes or wall panelling. EGGER Eurodekor Plus ML meets increased requirements for impact resistance thanks to special multiple-layer structures up to 1 mm thick. Multi-layer structures are both very resistant to bending and stable and are therefore well suited for constructions with large spans. On request, an additional overlay (Eurodekor Plus HR) can be added for special abrasion requirements. In the proven EGGER quality in decor and material composite, EGGER Eurodekor offers a contemporary and aesthetically sophisticated solution.

General machining guidelines

When machining EGGER Eurodekor boards, the reference values from the table for the selection of the cutting speed (v_c) and the tooth feed rate (f_z) should be observed, depending on the machining method.

Machining method	Cutting speed v_c [m/s]
Sawing	60 - 90
Hogging	60 - 80
Cutting	50 - 70
Boring	0.5 - 2.0

Machining method	Tooth feed rate f_z [mm]
Sawing	0.05 - 0.15
Hogging	0.15 - 0.25
Cutting	0.50 - 0.80
Boring	0.05 - 0.25



These parameters are in relation to the tool diameter (D), number of teeth (Z), RPM (n) and feed speed (v_f) used on the processing machine. The right selection of these factors is responsible for a good machining result.

The following formulas apply to the calculation of cutting speed, tooth feed rate and feed speed:

v_c – Cutting speed [m/s]

$$v_c = D \cdot \pi \cdot n / 60 \cdot 1000$$

D – Tool diameter [mm]

n – RPM of tool [min^{-1}]

f_z – Tooth feed rate [mm]

$$f_z = v_f \cdot 1000 / n \cdot z$$

v_f – Feed speed [m/min]

n – RPM of tool [min^{-1}]

Processing recommendation

EGGER Eurodekor and Eurodekor Plus boards

z – Number of teeth

v_f – Tooth feed rate [m/min-1]

$$v_f = f_z \cdot n \cdot z / 1000$$

f_z – Feed speed [mm]

n – RPM of tool [min^{-1}]

z – Number of teeth

Cutting material

Basically, both tools with carbide cutting edges (HW) and diamond cutting edges (DP diamond polycrystalline) can be used. The use of tools with diamond cutting edges (DP) is recommended in order to extend the tool life at high cutting volume.

Processing recommendation

EGGER Eurodekor and Eurodekor Plus boards

Cutting the panels with circular sawblades

General note:

- Visible side (decorative side with foil) upwards
- Make sure that the sawblade protrudes correctly (see table)
- Adjust RPM and number of teeth to feed speed
- The use of a scoring sawblade is recommended for precise cuts on the bottom side of the panel

Depending on the sawblade protrusion, the entry and exit angle and thus the quality of the cutting edge change. If the top cutting edge becomes rough, set the sawblade higher. If the cut on the bottom side is rough, the sawblade must be set lower. In this way the most favorable height setting must be determined.

The following sawblade protrusions (\ddot{U}) must be set for sizing and panel sizing saws, depending on the diameter (D):

Circular sawblade diameter D [mm]	Protrusions \ddot{U} [mm]
D 250	ca. 10 - 20
D 300	
D 350	
D 400	
D 450	



Sawblades with a high number of teeth are generally recommended for good machining quality. For circular sawing, the recommended cutting speed v_c is 60 - 90 m/s.

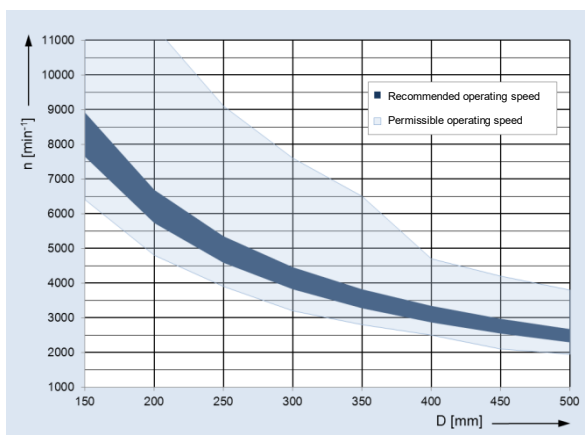

Speed diagram – depending on the circular sawblade diameter

Processing recommendation

EGGER Eurodekor and Eurodekor Plus boards

Recommended tooth shapes

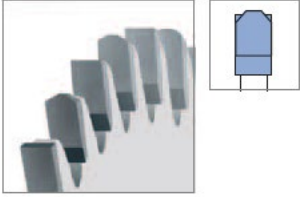
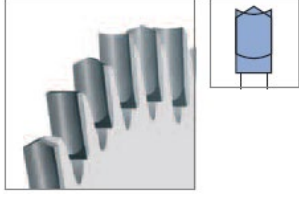
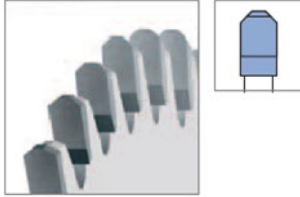
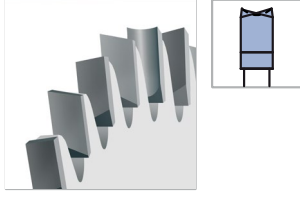
			
<p>FZ/TR (flat tooth/trapezoidal tooth)</p>	<p>HZ/DZ (hollow tooth/ inverted-V tooth)</p>	<p>TR/TR (trapezoidal tooth/ trapezoidal tooth)</p>	<p>HZFA/WZFA (bevelled hollow tooth/ alternate top bevel tooth)</p>

Processing recommendation

EGGER Eurodekor and Eurodekor Plus boards

Sizing sawblades

with the saw tooth shape hollow tooth/V-tooth (HZ/DZ) provide the best cutting results on machines without scoring unit. On machines with a scoring unit, the flat tooth/trapezoidal tooth (FZ/TR) sawblade shape also offers good cutting results with a higher tool life compared to HZ/DZ.

Sizing cut without pre-scoring *Excellent*

D [mm]	SB [mm]	TDI [mm]	BO [mm]	NLA [mm]	Z	ZF	SW °	ID
250	3.2	2.2	30	KNL	54	HZ/DZ	10	161300
303	3.2	2.2	30	KNL	68	HZ/DZ	10	161301
350	3.5	2.5	30	KNL	80	HZ/DZ	10	161302

Other dimensions available on request

Sizing cut with pre-scoring *Premium*

D [mm]	SB [mm]	TDI [mm]	BO [mm]	NLA [mm]	Z	ZF	Type	SW °	ID
250	3.2	2.2	30	KNL	60	FZ/TR	UT	10	163002
250	3.2	2.2	30	KNL	80	FZ/TR		10	163003
300	3.2	2.2	30	KNL	72	FZ/TR	UT	10	163005
300	3.2	2.2	30	KNL	96	FZ/TR		10	163006
350	3.5	2.5	30	KNL	84	FZ/TR	UT	10	163007
350	3.5	2.5	30	KNL	108	FZ/TR		10	163008

Other dimensions available on request

In order to create a work-friendly machining, WhisperCut circular sawblades with DP cutting material are recommended. WhisperCut circular sawblades produce up to 10 dB(A) less noise and can be used with standard splitting wedges on machines with scoring unit.

Sizing cut *Excellent* – WhisperCut

D [mm]	SB [mm]	TDI [mm]	BO [mm]	NLA [mm]	Z	ZF	SW °	ID
250	3.2	2.4	30	KNL	50	HZFA/WZFA	10	190697
303	3.2	2.4	30	KNL	60	HZFA/WZFA	10	190698
350	3.2	2.4	30	KNL	70	HZFA/WZFA	10	190699

Other dimensions available on request

Processing recommendation

EGGER Eurodekor and Eurodekor Plus boards

Panel sizing sawblades

with saw tooth shape combinations such as flat / trapezoidal tooth (FZ/TR) or trapezoidal / trapezoidal tooth (TR/TR) are recommended for this purpose. The Leitz RazorCut (TR/TR) saw type achieves the best cutting quality here.

Splitting individual panels and panel stacks – Premium

D [mm]	SB [mm]	TDI [mm]	BO [mm]	NLA [mm]	Z	ZF	SW °	ID
300	4.4	3.2	30	KNL	60	FZ/TR	15	163400
350	4.4	3.2	60	KNL	72	FZ/TR	15	163408
350	4.4	3.2	60	2/14/100	72	FZ/TR	15	163409
380	4.8	3.5	60	2/14/100 2/14/125	72	FZ/TR	15	163418
380	4.4	3.2	30	2/14/100 2/14/125	72	FZ/TR	15	163419

Other dimensions available on request

Splitting individual panels in finish cut quality *Excellent* – RazorCut

D [mm]	SB [mm]	TDI [mm]	BO [mm]	NLA [mm]	Z	ZF	SW °	ID
300	4.4	3.2	30	KNL	60	TR/TR	15	161102
350	4.4	3.2	60	KNL	72	TR/TR	15	161108
350	4.4	3.2	60	2/14/100	72	TR/TR	15	161109
380	4.8	3.5	60	2/14/100 2/14/125	72	TR/TR	15	161116
380	4.4	3.2	30	2/14/100 2/14/125	72	TR/TR	15	161117

Other dimensions available on request

Processing recommendation

EGGER Eurodekor and Eurodekor Plus boards

Scoring sawblades

With EGGER Eurodekor boards, the use of a scoring unit is recommended to achieve good cutting edge quality on the tooth exit side. The cutting width of the scoring sawblade must be set slightly larger than that of the main circular sawblade so that the exiting tooth of the main saw can no longer touch the cutting edge. Divided scoring sawblades are used on circular saw benches and sizing saw machines.

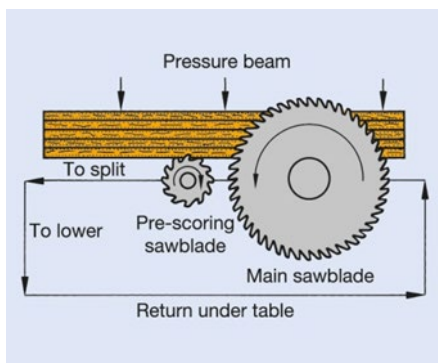

Panel sizing system with scoring unit and pressure device

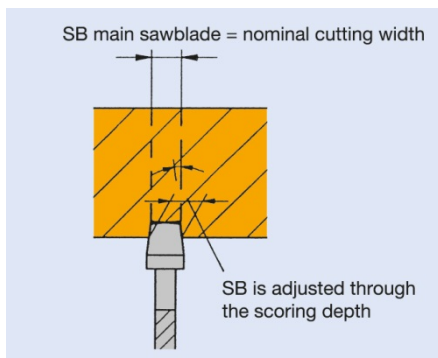

Application diagram of conical scoring sawblade. When repairing the tools, it is recommended to sharpen the scoring saws with the main saws in a set.

All dimensions available on request

Processing recommendation

EGGER Eurodekor and Eurodekor Plus boards

Jointing on table milling machine or throughfeed systems

In order to produce edges free of break-outs on the cover layers of the panel, jointing tools with alternate shear angles should be used. Diamond cutterheads such as Leitz WhisperCut with a shear angle of 30° to 50° are recommended. The chip removal should be as low as possible and not exceed 2 mm.

For good cutting results, it is advantageous to use tools with high concentricity and balance quality which are achieved by using centering adaptors such as hydraulic clamping systems, HSK holders or shrink-fit clamping systems.

Only tools marked "MAN" or "BG-Test" may be used when working with manual feed on table milling machines. Furthermore, for safety reasons, the speed range specified on the tool must not be exceeded or fallen short of. The tools for manual feed may only be used when running against the feed.

Tool examples:

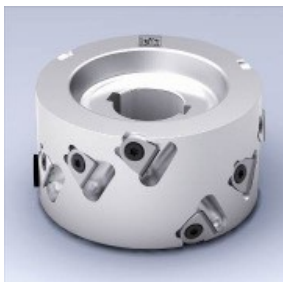

DP-jointing cutter WhisperCut

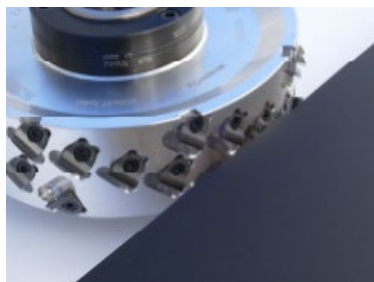

DP-WhisperCut EdgeExpert



DP-jointing cutter with fixed tipping



DP-jointing cutter EdgeExpert

The application parameters of the jointing cutters should be selected so that the tooth feed (f_z) is between 0.5 and 0.8 mm. The DP-WhisperCut version is recommended for perfect cutting results.

Processing recommendation

EGGER Eurodekor and Eurodekor Plus boards

Dimensions DxSBxB0 [mm]	RPM n [min ⁻¹]	No. of teeth Z	Feed speed v _f [m/min]	Leitz ID, DP WhisperCut		Machine
				LH	RH	
85x43x30	12.000	3	14 - 25	192076	192077	Ott
100x32x30	12.000	3	14 - 25	192090	192091	IMA
100x43x30	12.000	2	8 - 18	192082	192083	Stefani, Holz Her
100x43x30	12.000	2	8 - 18	192080	192081	Hebrock, EBM
100x43x30	12.000	3	14 - 25	192088	192088	Biesse
100x43x30	12.000	3	14 - 25	90885	90886	Brandt
125x32x30	9.000	3	14 - 25	192092	192093	IMA
125x43x30	9.000	3	14 - 25	75627	75627	Homag, Biesse
125x43x30	9.000	3	14 - 25	192094	192095	IMA

Other dimensions available on request

Processing recommendation

EGGER Eurodekor and Eurodekor Plus boards

Hoggers for throughfeed machines

Diamond compact hoggers, which generate little friction and cutting pressure, are recommended. The Leitz Diamaster DT Premium type mounted on a hydraulic clamping element is particularly suitable for maximum radial and axial runout and excellent machining quality and tool life. The cutting speed (v_c) is 80 m/s at the usual speed (n) 6000 min^{-1} and diameter (D) 250 mm. The application parameters and the number of teeth of the hoggers should be selected so that the tooth feed (f_z) is between 0.15 - 0.25 mm.

Dimensions DxSBxBo [mm]	RPM n [min^{-1}]	No. of teeth Z	Feed speed v_f [m/min]	Leitz ID, DT Premium	
				LH	RH
250x10x60	6.000	24	25 - 33	190410	190411
250x10x60	6.000	36	32 - 43	190418	190419
250x10x60	6.000	48	39 - 53	190426	190427
250x10x60	6.000	60	45 - 80	190434	190435

Other dimensions available on request



Leitz DT Premium hogger

Processing recommendation

EGGER Eurodekor and Eurodekor Plus boards

Edge processing on edge banding machines

Radii cutters and scrapers on edge banding machines must be set so that the tools do not touch the tool material. For panels with protective foil, the foil must not be damaged.

Radii cutter / bevel cutter

Radii cutters should have a profile run-out of at least 10° . The setting of the radius and bevel cutters must be selected so that there is only contact with the edge.

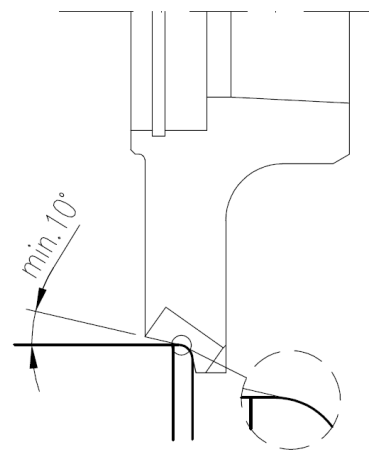

Profile scrapers

Profile scrapers are equipped with a profile relief and can easily be used for finishing the EGGER Eurodekor boards with exact adjustment.

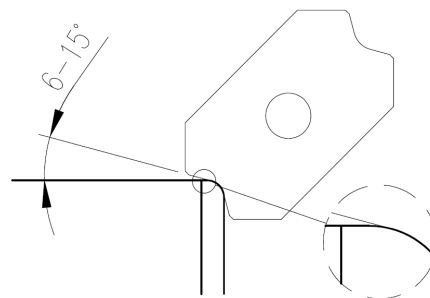

Flat scrapers

Flat scrapers should preferably have an inclination of $2 - 4^\circ$ from the edge to the plate.

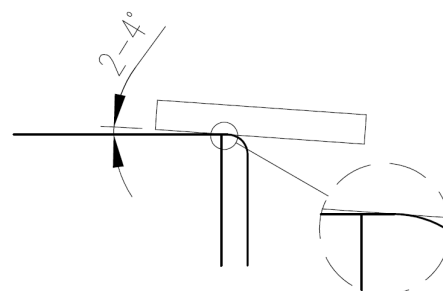

All dimensions available on request

Processing recommendation

EGGER Eurodekor and Eurodekor Plus boards

Groove processing

For grooving, the number of teeth of the tool should be selected in relation to feed speed for optimum edge quality. The tooth feed rate (f_z) should be in the range of 0.06 - 0.2 mm when machining with feed (GLL).

RPM n [min^{-1}]	No. of teeth Z	Feed speed v_f [m/min]
6000	24	8 - 16
6000	36	13 - 26
6000	48	17 - 35

Other dimensions available on request

CNC Machining Centres

Spiral solid carbide cutters (VHW) or preferably diamond tipped (DP) routers are best suited for machining on router and machining centres.

Good workpiece clamping on the machine must be ensured. We recommend stable and rigid Leitz Thermo-Grip® shrink chucks for maximum concentricity, balance quality and perfect cutting quality. A good machining result can only be achieved with sufficient rigidity of the machine.

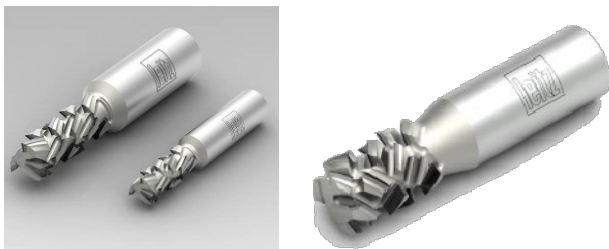

Recommended application data:

RPM n = 18.000 - 24.000 min^{-1}

Processing recommendation

EGGER Eurodekor and Eurodekor Plus boards

Grooving and sizing

Router cutter Diamaster PRO

Feed rate (v_f) depending on cutting depth a_p :

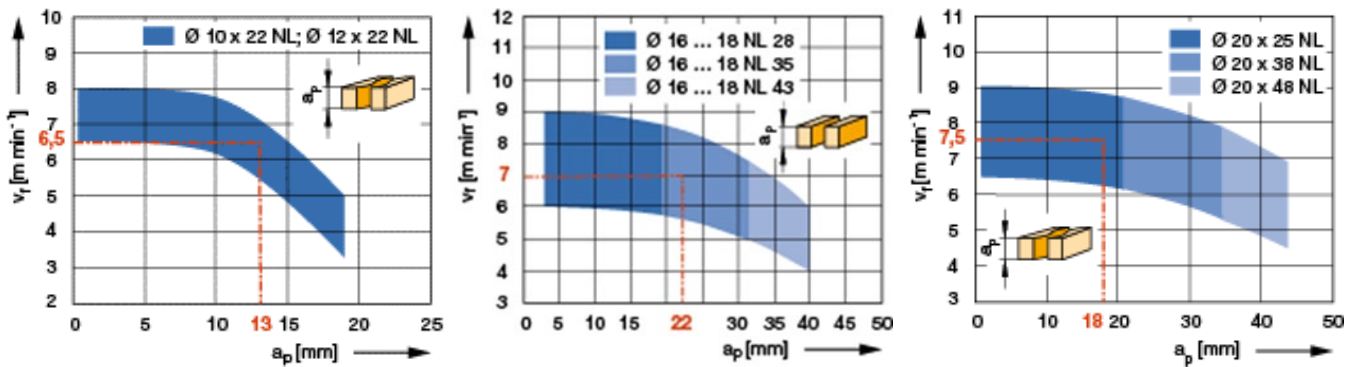

D [mm]	GL [mm]	NL [mm]	S [mm]	Leitz ID	
				LH	RH
10	70	22	12x40		091264
12	70	22	12x40		091265
12	90	28	20x50		191095
14	90	28	16x50		091267
16	90	28	16x50	091271	091270
16	100	28	25x60		091272
16	115	43	25x60	091276	091275
18	95	35	20x50		091278
18	105	43	20x60	091281	091280
20	100	28	25x60	091285	091284
20	95	35	20x60		091286
20	115	43	25x60		091290
20	120	48	25x60	091294	091293
20	130	58	25x60		191041

Other dimensions available on request

Processing recommendation

EGGER Eurodekor and Eurodekor Plus boards

Router cutter Diamaster QUATTRO

Feed rate (v_f) depending on cutting depth a_p :

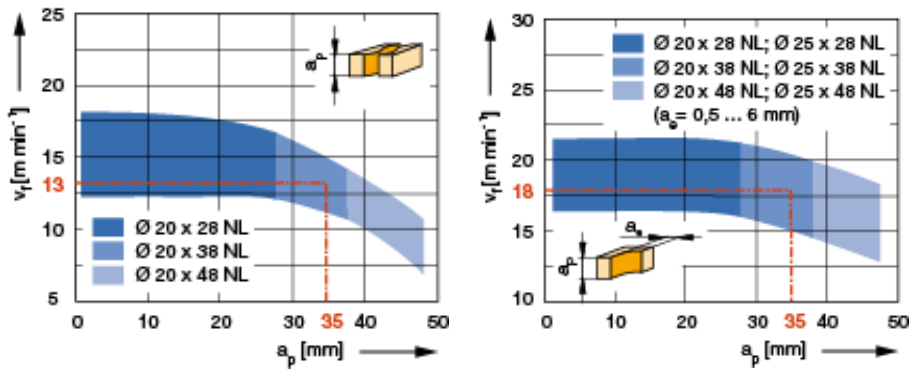

D [mm]	GL [mm]	NL [mm]	S [mm]	Leitz ID	
				LH	RH
20	90	28	20x50		091235
20	120	48	25x60	091246	091247
25	110	38	25x60		091251
25	120	48	25x60	091252	091253

Other dimensions or versions available on request

Processing recommendation

EGGER Eurodekor and Eurodekor Plus boards

Splitting using the nesting method

Production process with support panel

The workpiece is clamped as securely as possible on the machine table by means of a vacuum. The workpieces to be processed are usually supported by a thin MDF board, which is used as a “maxi-suction” and support panel for the machine grid table. The depth of the cutting tool is adjusted in order not to protrude the workpiece and cut into the support panel too much (max. 0.3 - 0.5 mm deeper).

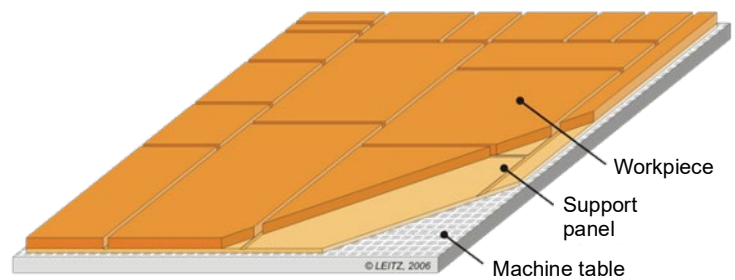
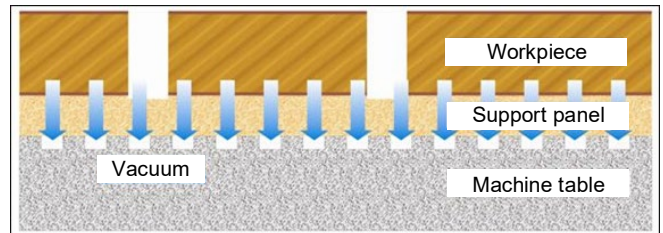

Production process with rubber mat

A rubber mat is used as a support through which the workpiece is clamped by means of a vacuum. The cutting tools are set or adjusted to a depth of 0.1 mm protrusion in order not to cut into the rubber too much (max. 0.05 - 0.1 mm deeper). This mat is replaced every 1 - 2 years.



Processing recommendation

EGGER Eurodekor and Eurodekor Plus boards

Router cutter in Nesting design

Router cutter HW-solid Z 2+2

Feed rate (v_f) depending on the cutting depth a_p :

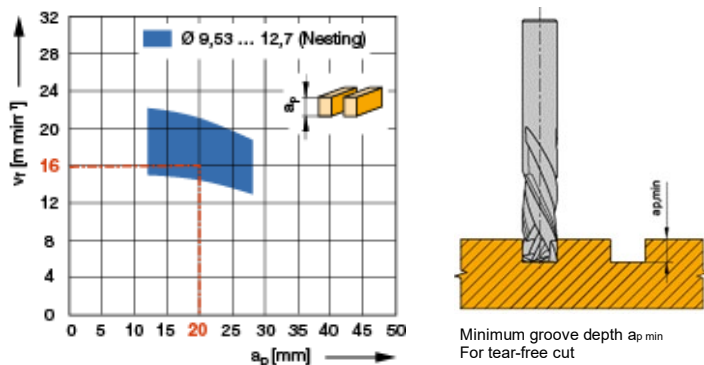

D [mm]	D [in]	GL [mm]	GL [in]	NL [mm]	NL [in]	S [mm]	S [in]	$a_{p \text{ min}}$ [mm]	DRI	Leitz ID
9,53	3/8"	76,2	3"	23	7/8"	9,53x40	3/8"x1 1/2"	5,5	RH	240518
9,53	3/8"	76,2	3"	28,6	1 1/8"	9,53x40	3/8"x1 1/2"	7	RH	240503
10		75		28		10x40		8	RH	240530
12,7	1/2"	76,2	3"	32	1 1/4"	12,7x40	1/2"x1 1/2"	5	RH	240504
12,7	1/2"	76,2	3"	32	1 1/4"	12,7x40	1/2"x1 1/2"	6	RH	240505
12,7	1/2"	88,9	3 1/2"	34,9	1 3/8"	12,7x40	1/2"x1 1/2"	6	RH	240506
12,7	1/2"	101,6	4"	43	1 5/8"	12,7x40	3/8"x1 5/8"	20	RH	240507

Other dimensions or versions available on request

Router cutter Diamaster PRO DP Z 2+2

Feed rate (v_f) depending on the cutting depth a_p :

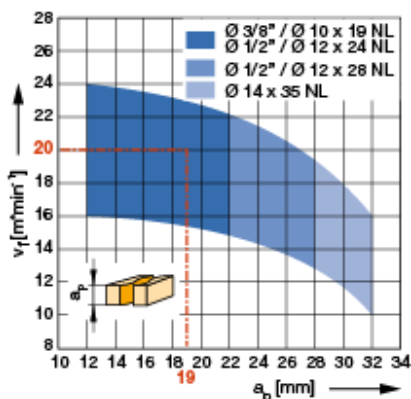

Table optimal workpiece thicknesses

Leitz ID	NL [mm]	Workpiece thickness [mm]
191059	19	9 - 16
191060	24	13 - 20 (22)
191061	28	19 - 25
191101	35	22 - 32

Processing recommendation

EGGER Eurodekor and Eurodekor Plus boards

D [mm]	GL [mm]	NL [mm]	S [mm]	DRI	Leitz ID
10	65	19	10x40	RH	191059
12	70	24	12x42	RH	191060
12	75	28	12x42	RH	191061
14	90	35	16x50	RH	191101

Other dimensions or versions available on request

Router cutter Diamaster PRO³ DP Z 3+3

Feed rate (v_f) depending on the cutting depth a_p :

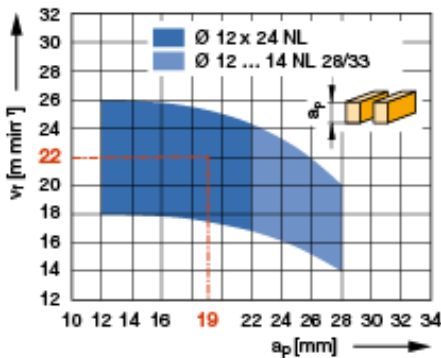

Table optimal workpiece thicknesses

Leitz ID	NL [mm]	Workpiece thickness [mm]
191030	19	9 - 16
191031	24	13 - 20 (22)
191032	28	19 - 25
191033	33	20 - 30

D [mm]	GL [mm]	NL [mm]	S [mm]	DRI	Leitz ID
12	65	19	12x42	RH	191030
12	70	24	12x42	RH	191031
12	75	28	12x42	RH	191032
14	90	33	16x50	RH	191033

Other dimensions or versions available on request

In order to find an optimal tool selection in connection with the machine, material and machining parameters, a consultation or recommendation from a Leitz application engineer is recommended.

Processing recommendation

EGGER Eurodekor and Eurodekor Plus boards

Boring

For boring, carbide-tipped or solid carbide (VHW) twist drills, dowel drills and hinge boring bits are recommended. On CNC machining centres, it is recommended to use the hinge boring bits in the main spindle instead of in the drilling beam due to higher stability.

For all applications, the following tools can be used according to the tables below:

Dowel drill

RPM n [min^{-1}] 3000 - 8000
 Feed speed v_f [m/min] 0.5 - 3.0

Dowel drills HW-solid – *Excellent*

D [mm]	GL [mm]	L [mm]	NL [mm]	S [mm]	Leitz ID	
					LH	RH
3	70	68.5	16	10x45	042596	042597
5	70	68.5	35	10x27	033496	033497
8	70	68.5	35	10x27	033500	033501
10	70	68	35	10x27	033540	033541

Other dimensions available on request

Dowel drills HW-tipped – *Premium*

D [mm]	GL [mm]	L [mm]	NL [mm]	S [mm]	Leitz ID	
					LH	RH
5	70	68.5	35	10x30	033484	033485
5.1	70	68.5	35	10x30	033492	033493
8	70	68.5	35	10x30	033488	033489
10	70	68.5	35	10x30	033490	033491

Other dimensions available on request

Processing recommendation

EGGER Eurodekor and Eurodekor Plus boards

Through-hole boring bit

RPM n [min⁻¹] 3000 - 8000
 Feed speed v_f [m/min] 0.5 - 3.0

D [mm]	GL [mm]	NL [mm]	S [mm]	Leitz ID	
				LH	RH
5	70	35	10x27	034100	034101
8	70	35	10x25	034104	034105
10	70	35	10x22	034114	034115

Through-hole drills HW-tipped – Premium

D [mm]	GL [mm]	NL [mm]	S [mm]	Leitz ID	
				LH	RH
5	70	35	10x25	033964	033965
8	70	35	10x25	033966	033967

Other dimensions available on request

Hinge boring bit

RPM n [min⁻¹] 3000 - 8000
 Feed speed v_f [m/min] 0.5 - 3.0

For hinge bores, Leitz recommends solid carbide hinge boring bits:

Hinge boring bits HW-solid

D [mm]	GL [mm]	L [mm]	S [mm]	Leitz ID	
				LH	RH
15	70	68	10x26	034812	034813
20	70	68	10x26	034814	034815
25	70	68	10x26	034816	034817
30	70	68	10x26	034820	034821
35	70	68	10x26	034822	034823

Other dimensions available on request

Processing recommendation

EGGER Eurodekor and Eurodekor Plus boards

For hinge bores in EGGER Eurodekor Plus ML06 panels, Leitz recommends solid carbide hinge boring bits with the bevel:

Hinge boring bit HW-solid with the bevel

D [mm]	GL [mm]	L [mm]	S [mm]	Leitz ID	
				LH	RH
15	70	68	10x26	130073401	130073400
20	70	68	10x26	130073403	130073402
25	70	68	10x26	130073405	130073404
30	70	68	10x26	130073409	130073408
35	70	68	10x26	130073411	130073410

Other dimensions available on request

Performance times

Tool performance times are influenced by a variety of factors, so that no performance time statements or rights can be derived within the scope of this machining guideline. The information on the tools and machining parameters are recommended guide values. Machine or process constellations can lead to deviating parameters. An optimal adaptation of machine, tool and material as well as customer-specific requirements can only be carried out on site together with a Leitz application engineer.

Processing recommendation

EGGER Eurodekor and Eurodekor Plus boards

Explanation of abbreviations

A	= dimension A	LH	= left hand rotation
a_r	= cutting thickness (radial)	M	= metric thread
a_p	= cutting depth (axial)	MBM	= minimum order quantity
ABM	= dimension	MC	= multi-purpose steel, coated
APL	= panel raising length	MD	= thickness of knife
APT	= panel raising depth	min^{-1}	= revolutions per minute (RPM)
AL	= working length	MK	= morse taper
AM	= number of knives	m min^{-1}	= metres per minute
AS	= anti sound (low noise design)	m s^{-1}	= metres per second
b	= overhang	n	= RPM
B	= width	n_{max}	= maximum permissible RPM
BDD	= thickness of shoulder	NAL	= position of hub
BEM	= note	ND	= thickness of hub
BEZ	= description	NH	= zero height
BH	= tipping height	NL	= cutting length
BO	= bore diameter	NLA	= pinhole dimensions
CNC	= Computerized Numerical Control	NT	= grooving depth
d	= diameter	P	= profile
D	= cutting circle diameter	POS	= cutter position
D0	= zero diameter	PT	= profile depth
DA	= outside Diameter	PG	= profile group
DB	= diameter of shoulder	QAL	= cutting material quality
DFC	= Dust Flow Control (optimised chip clearance)	R	= radius
DGL	= number of links	RD	= right hand twist
DIK	= thickness	RH	= right hand rotation
DKN	= double keyway	RP	= radius of cutter
DP	= polycrystalline diamond	S	= shank dimension
DRI	= rotation	SB	= cutting width
FAB	= width of rebate	SET	= set
FAT	= depth of rebate	SLB	= slotting width
FAW	= bevel angle	SLL	= slotting length
FLD	= flange diameter	SLT	= slotting depth
f_z	= tooth feed	SP	= tool steel
$f_{z, \text{eff}}$	= effective tooth feed	ST	= Cobalt-basis cast alloys, e.g. Stellite®
GEW	= thread	STO	= shank tolerance
GL	= total length	SW	= cutting angle
GS	= Plunging edge	TD	= diameter of tool body
H	= height	TDI	= thickness of tool
HC	= tungsten carbide, coated	TG	= pitch
HD	= wood thickness (thickness of workpiece)	TK	= reference diameter
HL	= high-alloyed tool steel	UT	= cutting edges with irregular pitch
HS	= high-speed steel (HSS)	V	= number of spurs
HW	= tungsten carbide (TCT)	v_c	= cutting speed
ID	= ident number	v_f	= feed speed
I	= insulation glazing	VE	= packing unit
KBZ	= abbreviation	VSB	= adjustment range
KLH	= clamping height	WSS	= workpiece material
KM	= edge breaker	Z	= number of teeth
KN	= single keyway	ZA	= number of fingers
KNL	= combination pinhole consists of 2/7/42 2/9/46,35 2/10/60	ZF	= tooth shape (cutting edge shape)
L	= length	ZL	= finger length
I	= clamping length		
LD	= left hand twist		
LEN	= Leitz standard profiles		

In this machining recommendation, corresponding parameters for optimum machining of the designated materials are presented. The information on tools and machining parameters are guideline values without any claim to completeness or general validity. Machine or process-related marginal conditions can lead to deviating application parameters. Individual adjustments may be necessary in individual cases. In particular, the respective manufacturer's information on the intended use of the machine, tool and material must be observed. No rights can be derived from this machining recommendation. For solutions to complex tasks, please contact our technical advisor.

The information is based on the current state of the art and has been prepared with particular care and to the best of our knowledge. Due to continuous technical development as well as new standards and laws, technical changes may occur.