

Panel Configurations

- **Wing Wall Panels**

- Postformed Edge + Flat Edge



- The Bullnose Edge is perfect for wing wall or terminating walls.
- Common market sizes of 30, 32, 34, and 36" panel widths

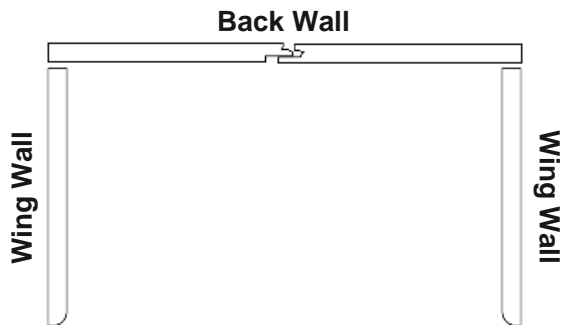

- **Back Wall Panels**

- Tongue Edge + Flat Edge



- The easy to handle TE/FE panels are ideal for a seamed back wall.
- Common market sizes of 30" panel widths

- **Groove Edge + Flat Edge**



- The easy to handle GE/FE panels are ideal for a seamed back wall.
- Common market sizes of 30" panel widths

- **Flat Edge + Flat Edge**



- The easy to handle FE/FE panels are best for a one-piece wall.
- Common market sizes of 34, 36, 42, 48, and 60" panel widths

Bath Configuration Samples

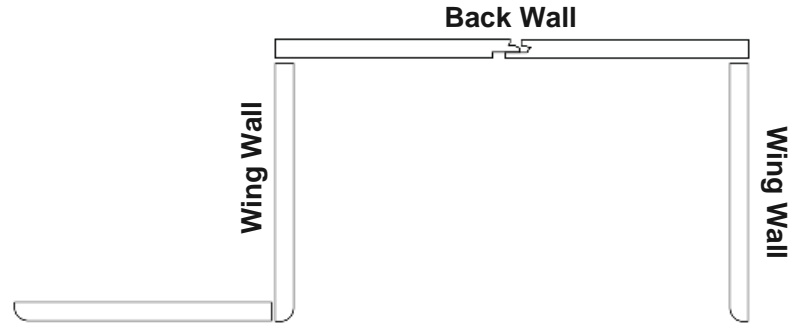
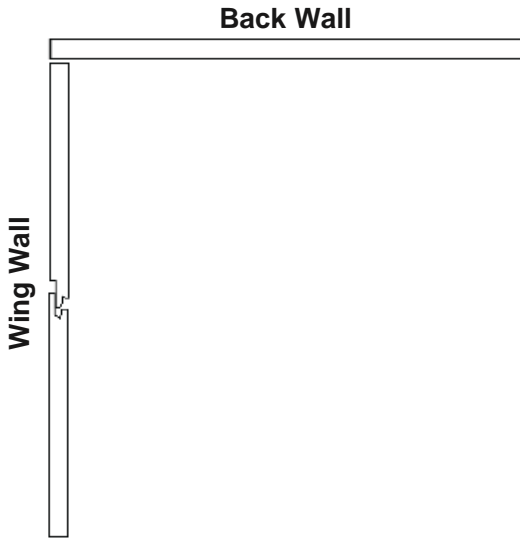
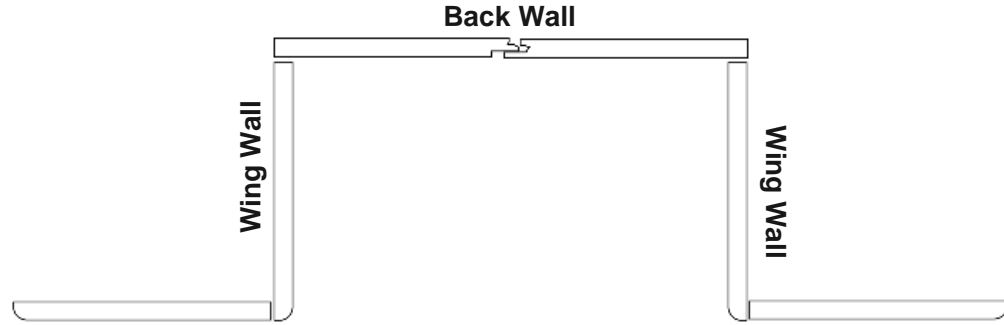
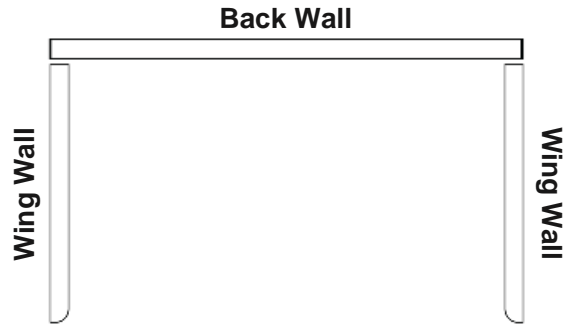

Bath/Shower Surrounds

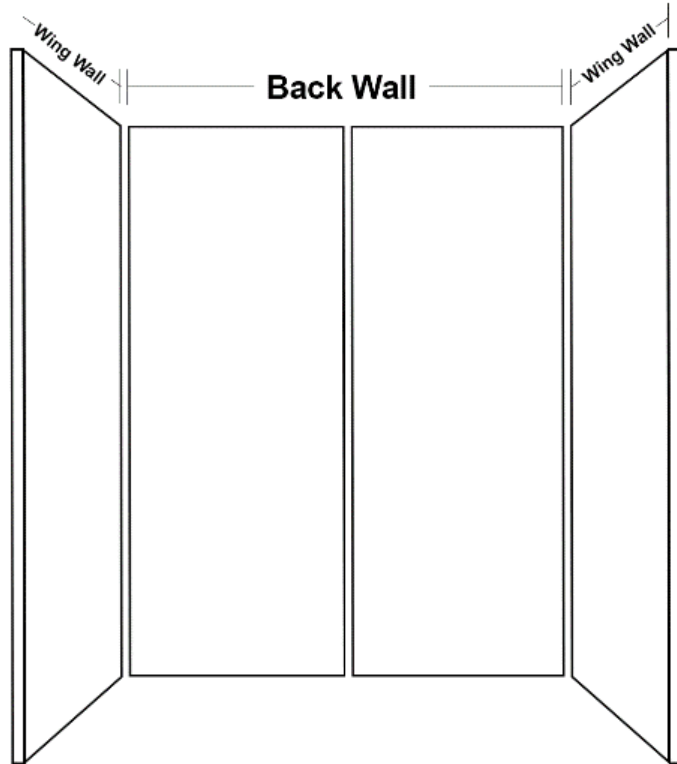

- Wing Wall
 - 30"
 - 32"
 - 34"
 - 36"
 - 42"
 - 48"
- Back Wall
 - 34"
 - 36"
 - 42"
 - 48"
 - 60"
- Height
 - 60"
 - 72"
 - 80"
 - 96"

Bath/Shower Surrounds

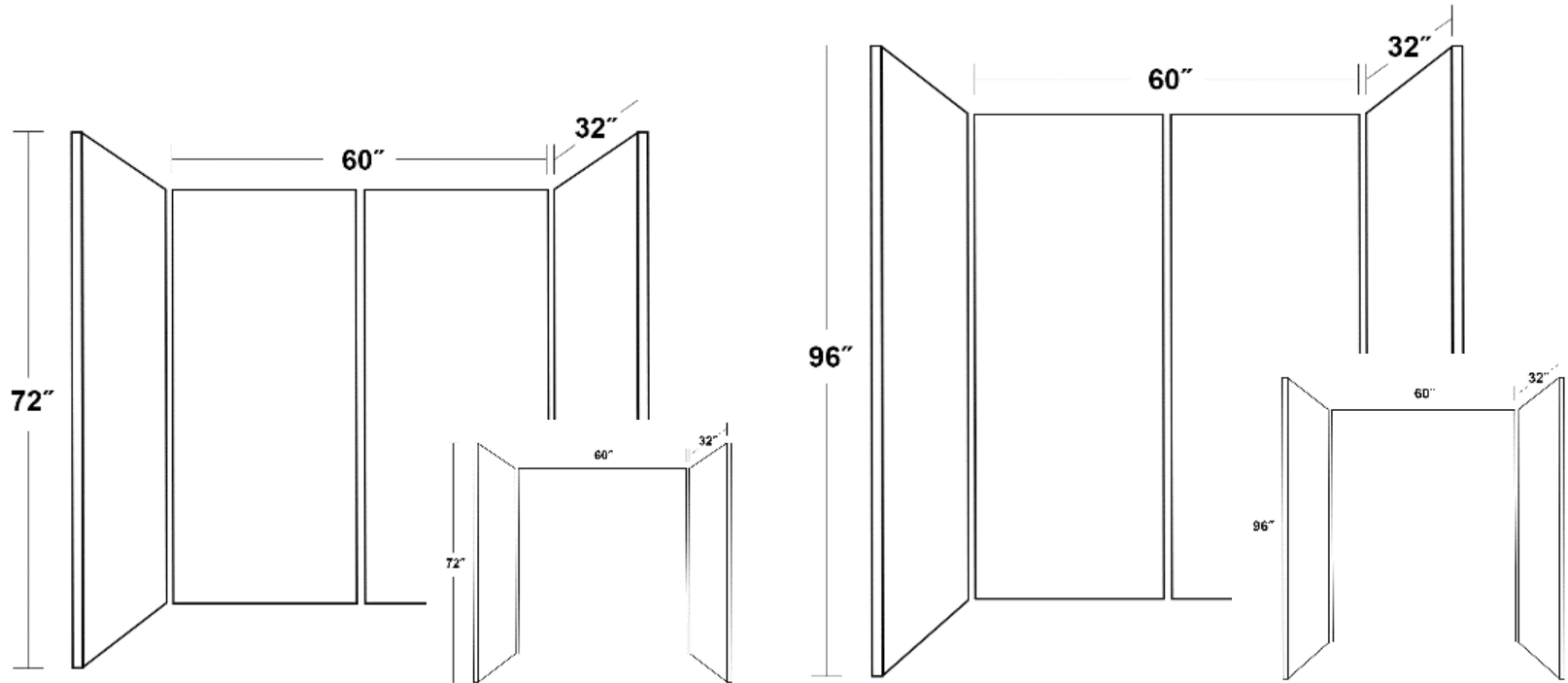

Bath/Shower Surrounds

Wetwall
— A WILSONART COMPANY —

