



DOMUS LINE

L I G H T S T Y L E



DOMUS Line Srl
Via Maestri del Lavoro, 1
33080 PORCIA _ PN _ Italy

phone 0039 0434 595911
fax 0039 0434 923345
e-mail info@domusline.com
website www.domusline.com

X-DRIVER

INSTALLATION MANUAL	EN
INSTALLATIONSHANDBUCH	DE
MANUEL D'INSTALLATION	FR
MANUAL DE INSTALACIÓN	ES
MANUALE DI INSTALLAZIONE E USO	IT

Ref. 3480900_r4



Device in insulation class II. Connection to the earthing circuit is not necessary.

Gerät der Isolierklasse II. Der Anschluss an einen geerdeten Kreislauf ist hier nicht notwendig.

Luminaire de classe II (isolation). Raccordement au circuit de mise à la terre non indispensable.

Aparato en clase de aislamiento II. No es necesaria la conexión al circuito de tierra.

Apparecchio in classe d'isolamento II. Non è necessaria la connessione al circuito di messa a terra.



Lamp power supply unit thermally protected at 110°C

Thermisch geschützten Lampe Netzgeräte bis 110°C

Alimentation de la lampe protégée thermiquement à 110°C.

Unidades de potencia de la lámpara de protección térmica a 110°C

Unità di alimentazione lampada protetta termicamente a 110°C.



Independent transformer specially designed to be installed "visible" (it can be used without the supplementary protective case and without being integrated into lights).

LED-Transformator für selbstständigen Einsatz bei "sichtbaren" Installationen (auch ohne zusätzliche Schutzhülle und ohne Einbau in Beleuchtungen einsetzbar).

Transformateur indépendant spécifique pour installations "à vue" (peut être utilisé sans bache de protection supplémentaire et sans être incorporé dans des appareils d'éclairage).

Transformador independiente, específico para instalaciones a la vista (se puede utilizar sin carcasa adicional de protección y sin incorporarlo a aparatos de iluminación).

Trasformatore per uso indipendente specifico per installazioni "a vista" (può essere utilizzato senza involucro supplementare di protezione e senza essere incorporato in apparecchi di illuminazione).



SELV
EQUIVALENT

This symbol indicates that the transformer complies with the European EN 61347-1 standard. The SELV symbol (Safety Extra Low Voltage) identifies a transformer in which touching the secondary circuit outputs, even if no lamps are connected, does not constitute a hazard.

Dieses Symbol zeigt an, dass der Transformator mit der Europäischen EN 61347-1 Standard entspricht. Das SELV-Symbol (Safety Extra Low Voltage) identifiziert einen Transformator, bei dem Berühren der Sekundärkreis-Ausgänge auch wenn keine Leuchten angeschlossen sind, keine Gefahr darstellen.

Il indique que le transformateur est conforme au normatif Européen EN 61347-1. Le symbole SELV (Safety Extra Low Voltage - Basse tension de sûreté) identifie un appareil en qui, aussi en service au vide (c'est-à-dire sans lampes relié), il est possible de toucher la sortie du secondaire sans quelques-uns danger.

Indica que el transformador está conforme a la normativa europeo EN 613147-1. El símbolo SELV (Safety Extra Low Voltage - Baja tensión de seguridad), identifica un aparato en el que, también en servicio a vacío (es decir sin lámparas unidas), es posible tocar la salida de lo secundario sin ningún peligro

Indica che il trasformatore è conforme alla normativa Europea EN 613147-1.

Il simbolo SELV (Safety Extra Low Voltage - Bassissima tensione di sicurezza) identifica un apparecchio nel quale, anche in servizio a vuoto (cioè senza lampade collegate), è possibile toccare l'uscita del secondario senza alcun pericolo.

The product must be disposed of separately from urban waste, delivering it to the collection centres established by the prevailing standard. Adequate sorted waste collection contributes to preventing negative effects on the environment and health and favours reuse and/or recycling materials. Incorrect disposal of the product implies the application of the administrative sanctions envisaged by the prevailing regulation.

Die Leuchte muss getrennt vom Hausmüll entsorgt und entsprechend der geltenden Richtlinien, an den vorgesehenen Sammelstellen abgegeben werden. Die angemessene getrennte Sammlung trägt dazu bei, eventuelle negative Auswirkungen auf die Umwelt und die Gesundheit zu vermeiden und die Wiederverwendung und/oder das Recycling der Materialien zu begünstigen. Die unsachgemäße Entsorgung bringt die Anwendung administrativer Strafen mit sich, die in den geltenden Richtlinien vorgesehen sind.

Le produit doit être collecté séparément et non jeté avec les déchets ménagers en le portant dans les déchetteries prévues par la réglementation en vigueur. Un tri sélectif approprié contribue à éviter des possibles effets négatifs sur l'environnement et sur la santé et favorise la réutilisation et/ou le recyclage des matériaux. L'élimination abusive entraîne l'application des sanctions administratives prévues par la réglementation en vigueur.

Se debe desechar el producto de forma separada de los residuos urbanos; se lo debe entregar en los centros de recolección previstos por la norma en vigor. La recolección diferenciada adecuada contribuye a evitar posibles efectos negativos en el medioambiente y en la salud y favorece la reutilización y/o el reciclaje de los materiales. Si se lo desecha en forma abusiva tendrá como consecuencia la aplicación de sanciones administrativas previstas por la normativa vigente.











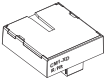
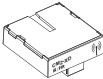
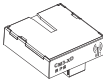
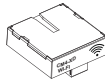
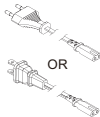

Il prodotto deve essere smaltito separatamente dai rifiuti urbani consegnandolo ai centri di raccolta previsti dalla normativa in vigore. L'adeguata raccolta differenziata contribuisce ad evitare possibili effetti negativi sull'ambiente e sulla salute e favorisce il reimpiego e/o il riciclo dei materiali. Lo smaltimento abusivo comporta l'applicazione delle sanzioni amministrative previste dalla normativa vigente.



Specifications

	X-DRIVER 15Watt	X-DRIVER 30Watt	X-DRIVER 60Watt
Input voltage	100-120VAC,220-240Vac (100-120VAC for North America only)		220-240Vac
Input frequency	50/60Hz		
Input current	0,25A for 100-120Vac 0,12A for 220-240Vac	0,40A for 100-120Vac 0,20A for 220-240Vac	0,40A for 220-240Vac
Output voltage	12-24Vdc	12-24Vdc	12-24Vdc
Rated output power	0-15W	0-30W	0-60W
Dimming range	2%-100%		
Operation mode	PWM+PFM		
Ambient temperature	-20...+40°C		
IP protection	IP20		

Optional Accessories Table

Type	MODULE CM1-XD	MODULE CM2-XD	MODULE CM3-XD	MODULE CM4-XD	Input Cable
Picture					
Function Characteristics	IR/IFR	IR/IFR/2.4G	IR/IFR/BT	ONLY APP	-
Functional Fittings	<p>PIR XD </p> <p>IR XD </p>	<p>IR XD </p> <p>PIR XD </p> <p>Call-ME V17 </p> <p>Rc3 </p> <p>Rc1 </p>	<p>IR XD </p> <p>PIR XD </p> <p>APP </p>	<p>APP </p>	-

INSTRUCTION MANUAL

SERIES: X-DRIVER 15-30-60Watt

CM1-XD

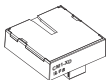

CM2-XD

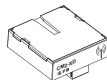

CM3-XD

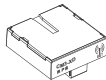

CM4-XD

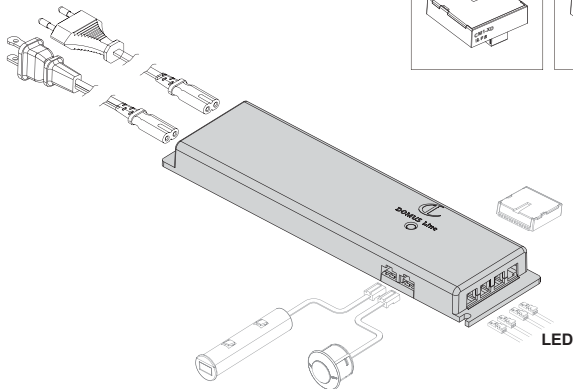
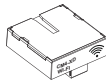

IR XD

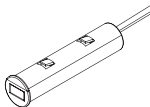

PIR XD

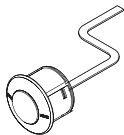

Module Installation

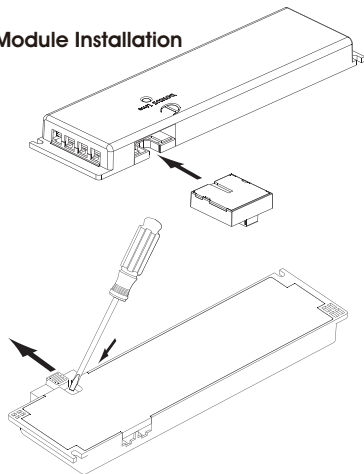

IR-XD LSW

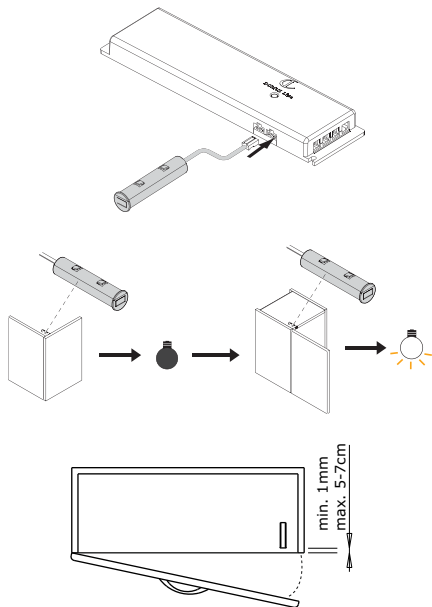

IR-XD DSW

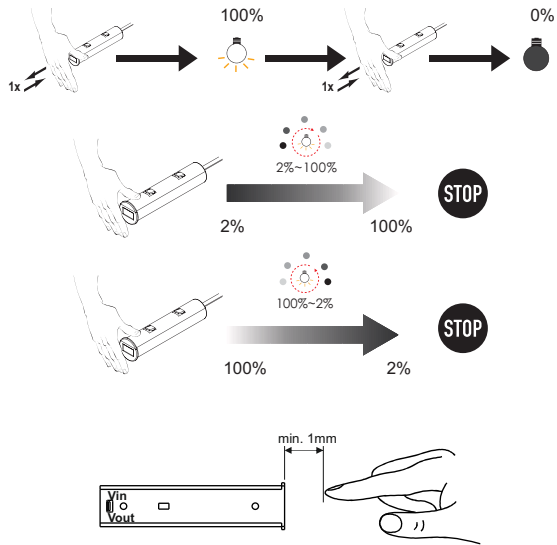

IFR XD

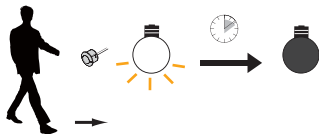
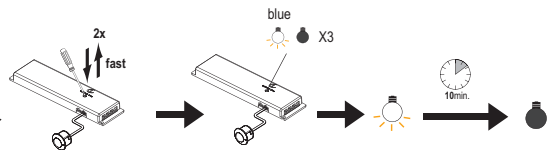
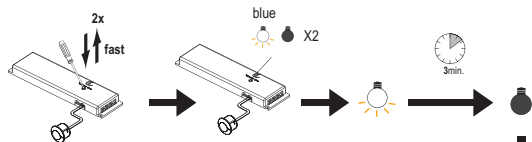
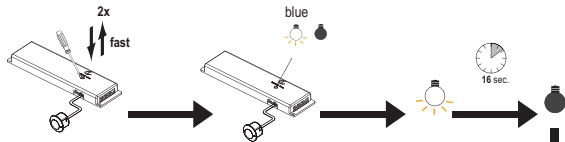
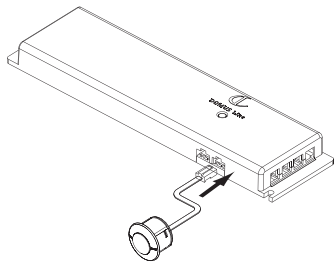

Remote Control matched transmitter

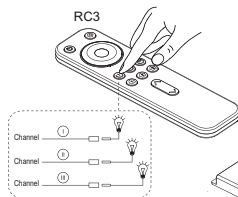
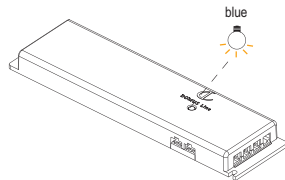
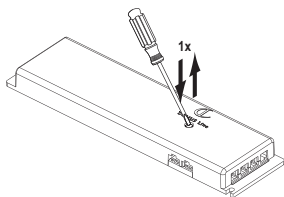

For detail instruction please see the manual of Remote controller dimmer or Remote controller 3 channels
Max.number of controllers connected for one smart driver: 7pcs

Remote controller RC1

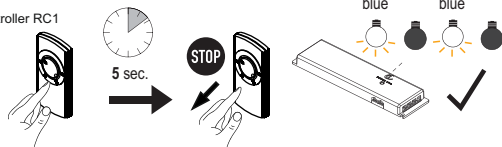

For detail instruction please see the manual of Remote controller dimmer
Max.number of controllers connected for one smart driver: 7pcs

Remote controller
dimmer CALL-ME V17

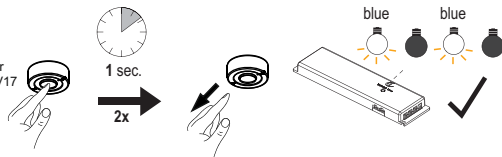

For detail instruction please see the manual of Remote controller CALL-ME V17
Max.number of controllers connected for one smart driver: 7pcs

Reset matched transmitter

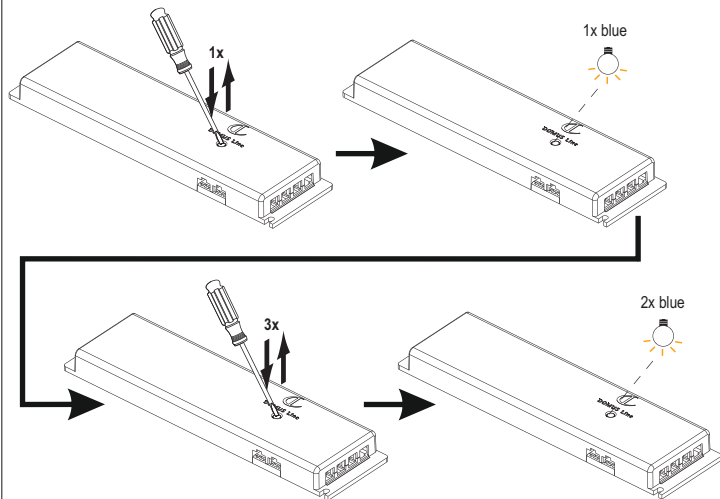

Call-ME V17



RC1



RC3



Remote control Function

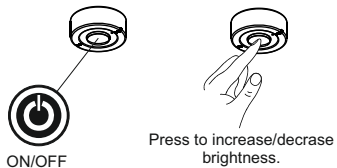
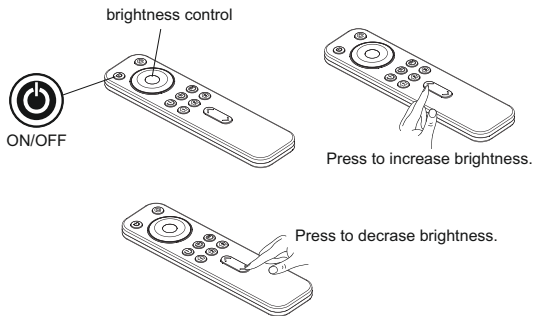
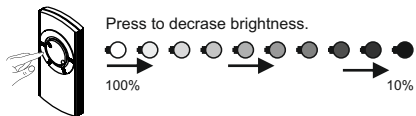
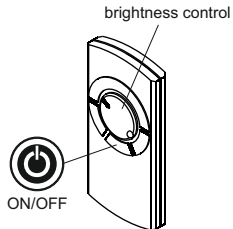

App. DOMUS 4U



Scan to download APP



Enter to the APP, press Info and read the instructions.

DOMUS 4U can control max. 5 X-DRIVER

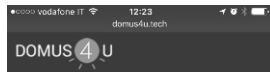

SEARCH FOR DEVICES

With the **DOMUS4U** application that uses the LE Bluetooth technology of your device to search for all the **Domus Line X-DRIVER** devices in your home, you can **switch on, switch off or adjust the brightness or light colour** of the devices connected to it with just a simple touch.

After selecting the devices, you will be able to store them and rename them however you like (for example, Kitchen lights, Bathroom lights, and so forth).



**GUARDA IL VIDEO TUTORIAL PER UNA
INSTALLAZIONE SEMPLICE E VELOCE
WATCH THE VIDEO TUTORIAL FOR QUICK
AND EASY INSTALLATION
VIDEO ANSEHEN PRIVATISSIMUM
SCHNELLE UND EINFACHE INSTALLATION
REGARDEZ LE TUTORIEL VIDÉO POUR
QUICK ET INSTALLATION FACILE
VER EL VIDEO TUTORIAL PARA
INSTALACIÓN RÁPIDA Y FÁCIL**

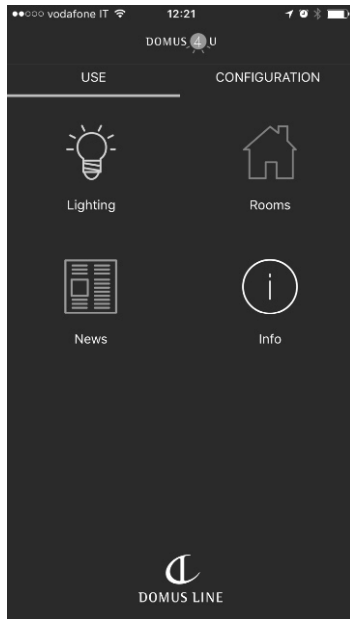



DOMUS 4U WI-FI
APP COMPATIBLE WITH X-DRIVER AND
CM4-XD TI MANAGE LIGHTS FROM
SMARTPHONES

DOWNLOAD THE APP:



<http://bit.ly/domus4uwifi>



<http://bit.ly/domus4uwifigoogleplay>

WARNING:

Safety is guaranteed if these instructions are followed and therefore they must be kept. Installation may require the involvement of qualified personnel. Before proceeding with installation of the device ensure that the environmental conditions are in compliance with and suitable for the product characteristics. Before any operation on the device disconnect mains power.

INTRODUCTION:

Power supply is designed exclusively for LED lamps. It can be used together with control modules, IR / PIR sensors, remote control remote controls and APP (see optional table accessories).

The built-in protection circuit turns off the power supply when there is a short circuit, overload or overheating.

X-DRIVER restarts automatically after the problem has been resolved.

WARRANTY:

The warranty on the device is valid only if powered by a power supply provided by DOMUS Line. The warranty's general terms and conditions for this device are available at www.domusline.com

HINWEIS:

Die Sicherheit wird nur gewährleistet, wenn diese Anweisungen befolgt werden. Sie sind daher aufzubewahren. Für die Montage kann qualifiziertes Personal erforderlich sein. Vor der Montage der Leuchte sicherstellen, dass die Umgebungsbedingungen konform und geeignet für die Produktmerkmale sind. Vor jeder Arbeit an Leuchten, die Netzspannung trennen.

WICHTIG:

Die Stromversorgung ist ausschließlich für LED-Lampen ausgelegt. Es kann zusammen mit Steuermodulen, IR / PIR-Sensoren, Fernbedienungen und APP (siehe optionales Zubehör) verwendet werden.

Die eingebaute Schutzschaltung schaltet die Stromversorgung bei Kurzschluss, Überlast oder Überhitzung ab.

X-DRIVER startet automatisch neu, nachdem das Problem behoben wurde.

GARANTIE:

Die Garantie auf die Leuchte ist nur gültig, wenn es mit einem Konverter der Firma DOMUS Line gespeist wird. Die allgemeinen Garantiebedingungen der Leuchten und Konverter stehen auf www.domusline.com zur Verfügung

MISE EN GARDE:

Il est important pour la sécurité des personnes de suivre ces instructions et de les conserver. L'installation peut exiger la participation de personnel qualifié. Avant de procéder à l'installation de l'appareil veiller à ce que les conditions environnementales soient conformes et appropriées aux caractéristiques du produit. Avant toute intervention sur l'appareil, couper la tension du secteur.

INTRODUCTION:

L'alimentation est conçue exclusivement pour les lampes LED. Il peut être utilisé avec les modules de commande, les capteurs IR / PIR, les télécommandes à distance et l'APP (voir accessoires de table en option).

Le circuit de protection intégré coupe l'alimentation en cas de court-circuit, de surcharge ou de surchauffe.

X-DRIVER redémarre automatiquement une fois le problème résolu.

GARANTIE:

La garantie de cet appareil est valable uniquement si ce dernier est alimenté par un transformateur fourni par DOMUS Line. Les conditions générales de garantie de cet appareil sont disponibles sur le site www.domusline.com

ATENCIÓN:

La seguridad está garantizada si se siguen estas instrucciones.

La instalación puede requerir la participación de personal cualificado. Antes de proceder con la instalación del dispositivo, asegúrese de que las condiciones ambientales son las adecuadas para el producto. Antes de cualquier operación hay que comprobar que la red eléctrica esté desconectada.

PREÁMBULO:

La fuente de alimentación está diseñada exclusivamente para lámparas LED. Se puede usar junto con módulos de control, sensores IR / PIR, controles remotos de control remoto y APP (ver accesorios de mesa opcionales).

El circuito incorporado apaga la fuente de alimentación cuando hay un cortocircuito, sobrecarga o sobrecalentamiento.

X-DRIVER se reinicia automáticamente después de que se haya resuelto el problema.

GARANTÍA:

La garantía del aparato es válida solamente si se lo alimenta con un alimentador proporcionado por DOMUS Line. Las condiciones generales de garantía de este aparato están a disposición en www.domusline.com

AVVERTENZA

La sicurezza è garantita se si seguono queste istruzioni e pertanto è necessario conservarle. L'installazione può richiedere il coinvolgimento di personale qualificato. Prima di procedere all'installazione dell'apparecchio assicurarsi che le condizioni ambientali siano conformi e idonee alle caratteristiche del prodotto. Prima di ogni operazione sull'apparecchio, disinserire la tensione di rete.

PREMESSA:

L'alimentatore è progettato esclusivamente per lampade a LED. Può essere usato insieme ai moduli di controllo, IR / sensori PIR, radiocomandi a distanza e APP (dettagli vedere accessori opzionali tabella). Il circuito di protezione incorporato spegne l'alimentatore in caso di: corto circuito, sovraccarico o sovratemperatura.

X-DRIVER si riavvia automaticamente dopo la sistemazione del problema riscontrato.

GARANZIA

Le condizioni generali di garanzia di questo apparecchio sono disponibili sul sito www.domusline.com