



Fusion de l'élégance avec la fonctionnalité. Voici une solution de rangement esthétique et entièrement personnalisable, construite avec une structure portante en aluminium combinée à une variété de supports pour étagères et armoires. **Préparez-vous à construire le garde-robres de vos rêves!**

Vertiko:

Vos vêtements sont beaux!

Ils méritent mieux que d'être cachés derrière des portes!

Inspiré par l'agencement des boutiques de luxe, Vertiko vous permet de faire un aménagement mural, qui va mettre votre garde robe en valeur.

Vertiko est composé de profils muraux dissimulés, fixés au mur et sur lesquels se fixent des panneaux décoratifs de votre choix (ép. 19mm 3/4"). Ces profils à crémaillère sont ensuite utilisés pour y fixer: tablettes, tablettes avec tringles de garde robe, armoires de rangement, à l'aide d'équerres métalliques, le tout avec une flexibilité de conception unique dans le marché. Les supports latéraux et centraux sont disponibles en fini tendance Gris et Brun.

Avec Vertiko, votre rangement donnera l'impression de "flotter" dans l'espace garde-robe!





Configurations réalisables:

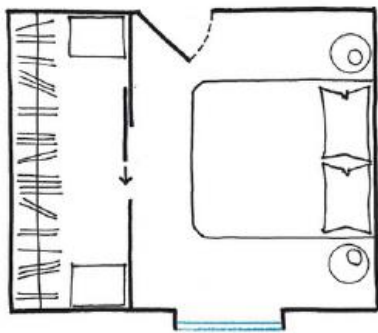

Linéaire

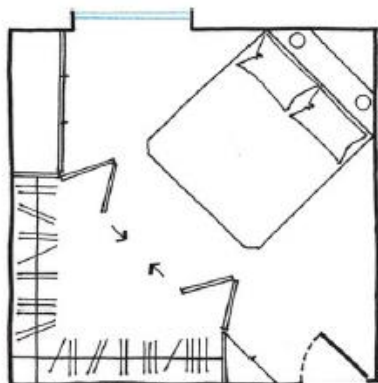

En angle à 90D

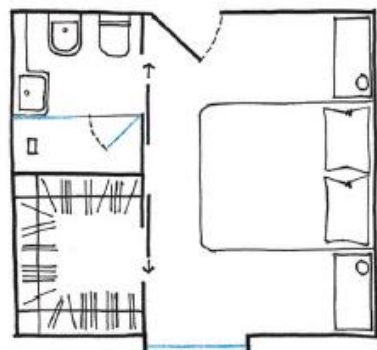

En U



2. Fabrication et ajouts des composantes de rangement

A) Tablettes simples ou multiples:

Épaisseur: 19mm (3/4") ou 25mm (1")

Profondeur: 350 ou 450mm (13.77" ou 17.71")

Largeur max.: 1000mm (39 3/8")

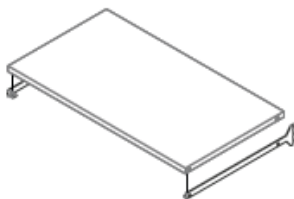
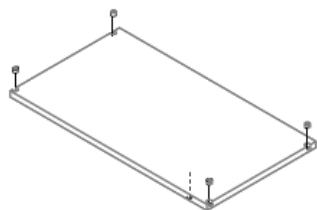

B) Tablettes inclinés (simples ou multiples) pour chaussures

Épaisseur: 19mm (3/4") ou 25mm (1")

Profondeur: 350mm (13.77")

Largeur max.: 1000mm (39 3/8")

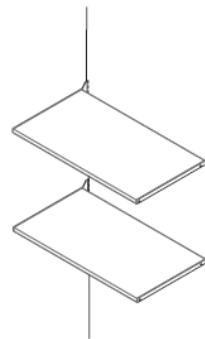

Tablettes avec tringle de garde robe (fixée par la dessous et au travers de la tablette):

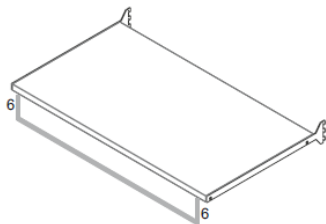

Armoires de rangement: voir notices de montage pour dimensions à respecter

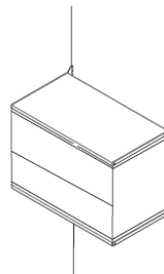
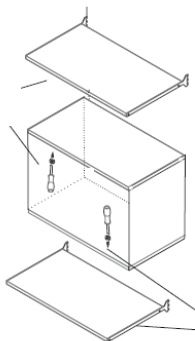
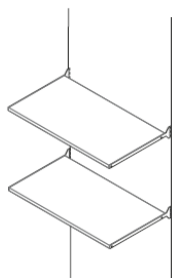

Consultez notices de montage et configurateurs en ligne

Quoi commander par application et type de matériau:

Configuration A: tablette simple

QTÉ	RÉFÉRENCE	Gris alu	Brun foncé	Dimensions
2	A	6781265100	678126560	450 X 25mm (17 ¾" x 1")
2	A	6781264100	678126460	450 x 19mm (17 ¾" x ¾")
2	A	6781275100	678127560	350 x 25mm (13 ¾" x 1")
2	A	6781277100	678127760	350 x 19mm (13 ¾" x ¾")

Supports inclinés pour tablette à souliers
(option: supports à chaussures de la série CSR)



QTÉ	RÉFÉRENCE	Gris alu	Brun foncé	Dimensions
2	A	678411100	67841160	350mmx25mm
2	A	678410100	67841060	350mmx19mm

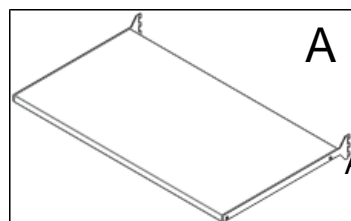

Gris

Brun

Pour souliers



Configuration B: tablettes doubles ou multiples

QTÉ	RÉFÉRENCE	Gris alu	Brun foncé	Dimensions
2	A	6781265100	678126560	450 X 25mm (17 ¾" x 1")
2	A	6781264100	678126460	450 x 19mm (17 ¾" x ¾")
2	A	6781275100	678127560	350 x 25mm (13 ¾" x 1")
2	A	6781277100	678127760	350 x 19mm (13 ¾" x ¾")
1	B	678298100	67829860	450 X 25mm (17 ¾" x 1")
1	B	678299100	67829960	450 x 19mm (17 ¾" x ¾")
1	B	678300100	67830060	350 x 25mm (13 ¾" x 1")
1	B	678301100	67830160	350 x 19mm (13 ¾" x ¾")

Supports inclinés pour tablette à souliers
(option: supports à chaussures de la série CSR)

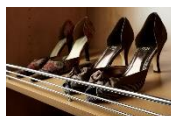

QTÉ	RÉFÉRENCE	Gris alu	Brun foncé	Dimensions
2	A	678411100	67841160	350 x 25mm (13 ¾" x 1")
2	A	678410100	67841060	350 x 19mm (13 ¾" x ¾")
1	B	678413100	67841360	350 x 25mm (13 ¾" x 1")
1	B	678412100	67841260	350 x 19mm (13 ¾" x ¾")

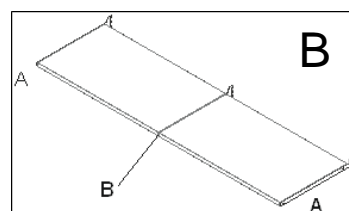

Gris

Brun



Pour souliers



Quoi commander par application et type de matériau:
Configuration C: caisson simple

QTÉ	RÉF.	GRIS	BRUN	DIMENSIONS
4	A	6781265100	678126560	450 X 25mm 17 ¾" x 1"
4	A	6781264100	678126460	450 x 19mm 17 ¾" x 3/4"
4	A	6781275100	678127560	350 x 25mm 13 ¾" x 1"
4	A	6781277100	678127760	350 x 19mm 13 ¾" x 3/4"

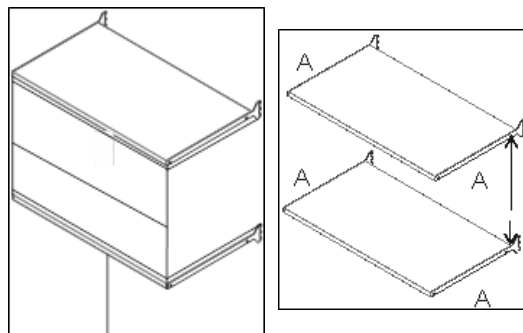
Gris

Brun
Configuration D : caisson double ou multiple

QTÉ	RÉF.	GRIS	BRUN	DIMENSIONS
4	A	6781265100	678126560	450 X 25mm 17 ¾" x 1"
4	A	6781264100	678126460	450 x 19mm 17 ¾" x 3/4"
4	A	6781275100	678127560	350 x 25mm 13 ¾" x 1"
4	A	6781277100	678127760	350 x 19mm 13 ¾" x 3/4"
2	B	678298100	67829860	450 X 25mm 17 ¾" x 1"
2	B	678299100	67829960	450 x 19mm 17 ¾" x 3/4"
2	B	678300100	67830060	350 x 25mm 13 ¾" x 1"
2	B	678301100	67830160	350 x 19mm 13 ¾" x 3/4"

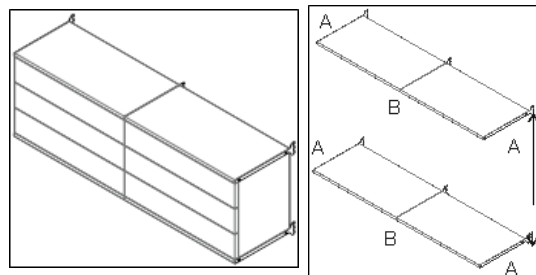
A : Gris

A : Brun

B : Gris

B : Brun

Quoi commander par application et type de matériau:

Configuration D2: caisson et tablette

QTÉ	RÉF.	GRIS	BRUN	DIMENSIONS
4	A	6781265100	678126560	450 X 25mm 17 ¾" x 1"
4	A	6781264100	678126460	450 x 19mm 17 ¾" x 3/4"
4	A	6781275100	678127560	350 x 25mm 13 ¾" x 1"
4	A	6781277100	678127760	350 x 19mm 13 ¾" x 3/4"
1	B	678298100	67829860	450 X 25mm 17 ¾" x 1"
1	B	678299100	67829960	450 x 19mm 17 ¾" x 3/4"
1	B	678300100	67830060	350 x 25mm 13 ¾" x 1"
1	B	678301100	67830160	350 x 19mm 13 ¾" x 3/4"

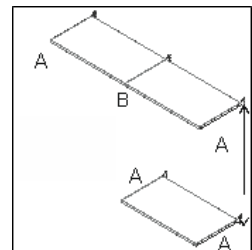
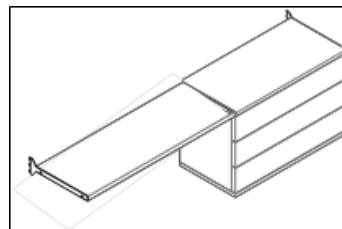

A : Gris



A : Brun



B : Gris



B : Brun

Configuration coin interne

QTÉ	RÉF.	GRIS	BRUN	DIMENSIONS
4	A	6781265100	678126560	450 X 25mm 17 ¾" x 1"
4	A	6781264100	678126460	450 x 19mm 17 ¾" x 3/4"



A : Gris



A : Brun

