

Installation Instruction of European Style Wardrobe Storage System

Basic components for wardrobe frame

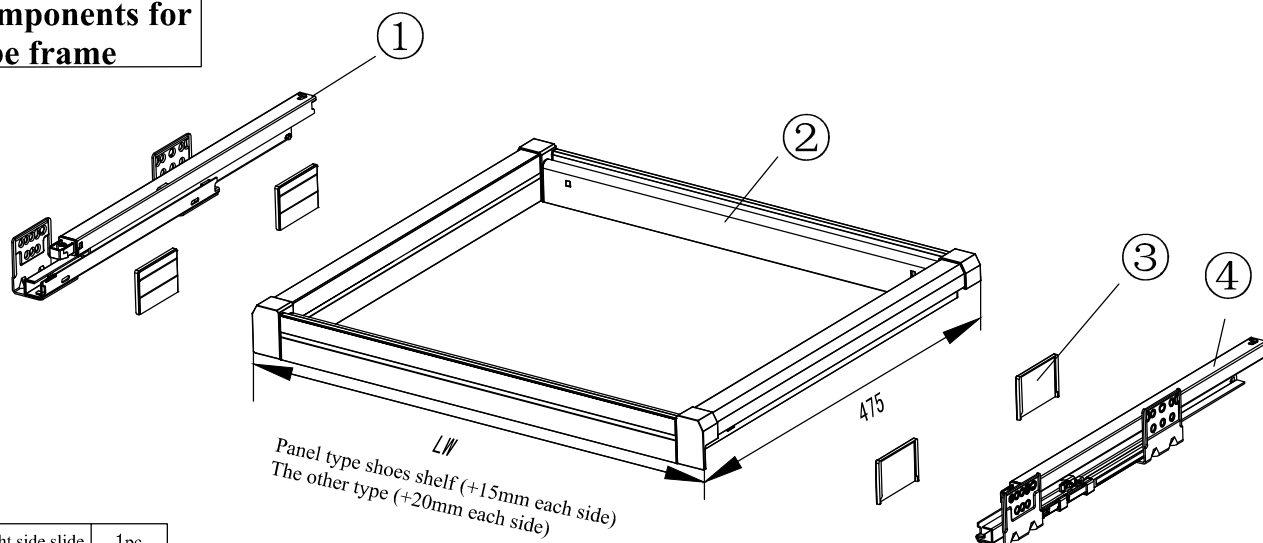

4	Right side slide	1pc
3	Plastic cover	4pcs
2	Frame	1pc
1	Left side slide	1pc
No.	Name	Qty.

Optional inner components

Multifunctional storage box

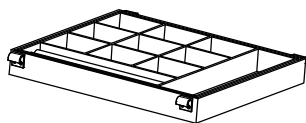

Size	600	800	900
------	-----	-----	-----

Semi-open type storage box

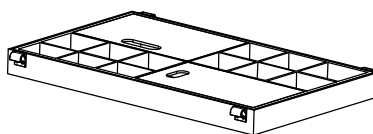

Size	800	900
------	-----	-----

PVC rattan storage basket

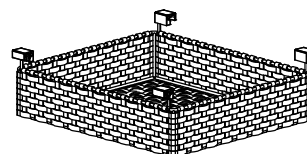

Size	600	800	900
------	-----	-----	-----

Flat and shallow board type storage basket

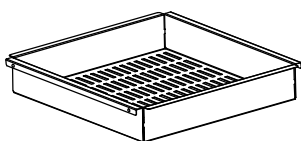

Size	600X80	700X80	800X80	900X80
	600X130	700X130	800X130	900X130

Metal wire storage basket

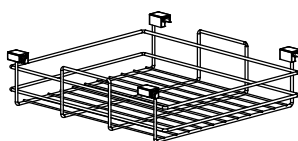

Size	600X120	800X120	900X120
	600X200	800X200	900X200

Simple trousers rack

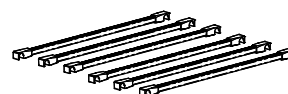

Size	600	700	800	900
------	-----	-----	-----	-----

Multifunctional plastic box and metal wire trousers rack

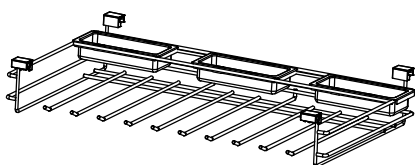

Size	600	800	900
------	-----	-----	-----

Board type shoes rack



Size	600	700	800	900
------	-----	-----	-----	-----

Multifunctional wooden box and aluminium bar trousers rack

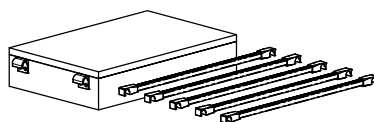

Size	800	900
------	-----	-----

Metal wire shoes rack

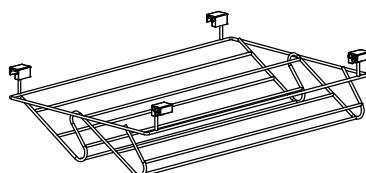

Size	600	800	900
------	-----	-----	-----

Multifunctional metal basket and aluminium bar trousers rack

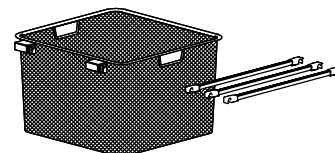

Size	800X200	900X200
	800X300	900X300

Note: The drawing is only for reference. The final specification and component quantity depends on the delivered goods.

Installation Instruction of European Style Wardrobe Storage System

Component installation

1

Installing left and right slide to the cabinet

2

Inserting plastic covers to the slides

3

Adjusting width of the frame, to make sure the slides work smoothly (adjustable underneath)

Panel type shoes shelf (+15mm each side)
The other type (+20mm each side)

4

Clamp fixing position

Pushing the frame into the slides (When hear "clip" means it's correctly fixed), and then check if it works smoothly

5

Putting inner components inside (Multifunctional storage as an sample in this instruction)

Component disassembling

Pull out the slide and then lift up the frame

Notes:

1. Runner doesn't steadily or pulse? ---Please ensure against wood chips or other scrap fall into runner interior during installation.
2. Runner doesn't work smoothly? ---Please check bottom and back panel measurement is up to the mustard or not; bottom pannel and cabinet is regularity or not; and runners are vertical and horizontal or not.
3. Runner can not clip on? ---Please ensue the runner is on the correct hole position.
4. Frame can not close well? ---Please ensue the runner is on the correct hole position, and ensure the clamp well fix on.