

Fitting for 2 top-running wooden doors up to 16 kg (35 lbs.), with screwed on or groove mounted running track. With soft and self closing mechanism. Design Inside.

Product highlights

Comfort Smooth, silent running with Comfort Roller and soft and self closing system for different door weights

Productivity Efficient thanks to tool-less door installation as well as easy, intuitive adjustment

Technical specifications

- Max. 16 kg (35 lbs.)
- Max. 1400 mm (4'7 1/8")
- Max. 1000 mm (3'3 3/8")
- 16–19 mm (5/8" to 3/4")

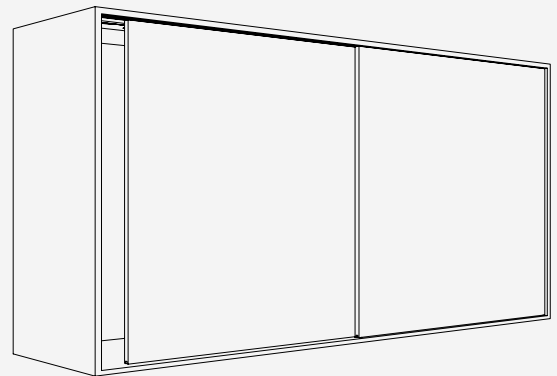



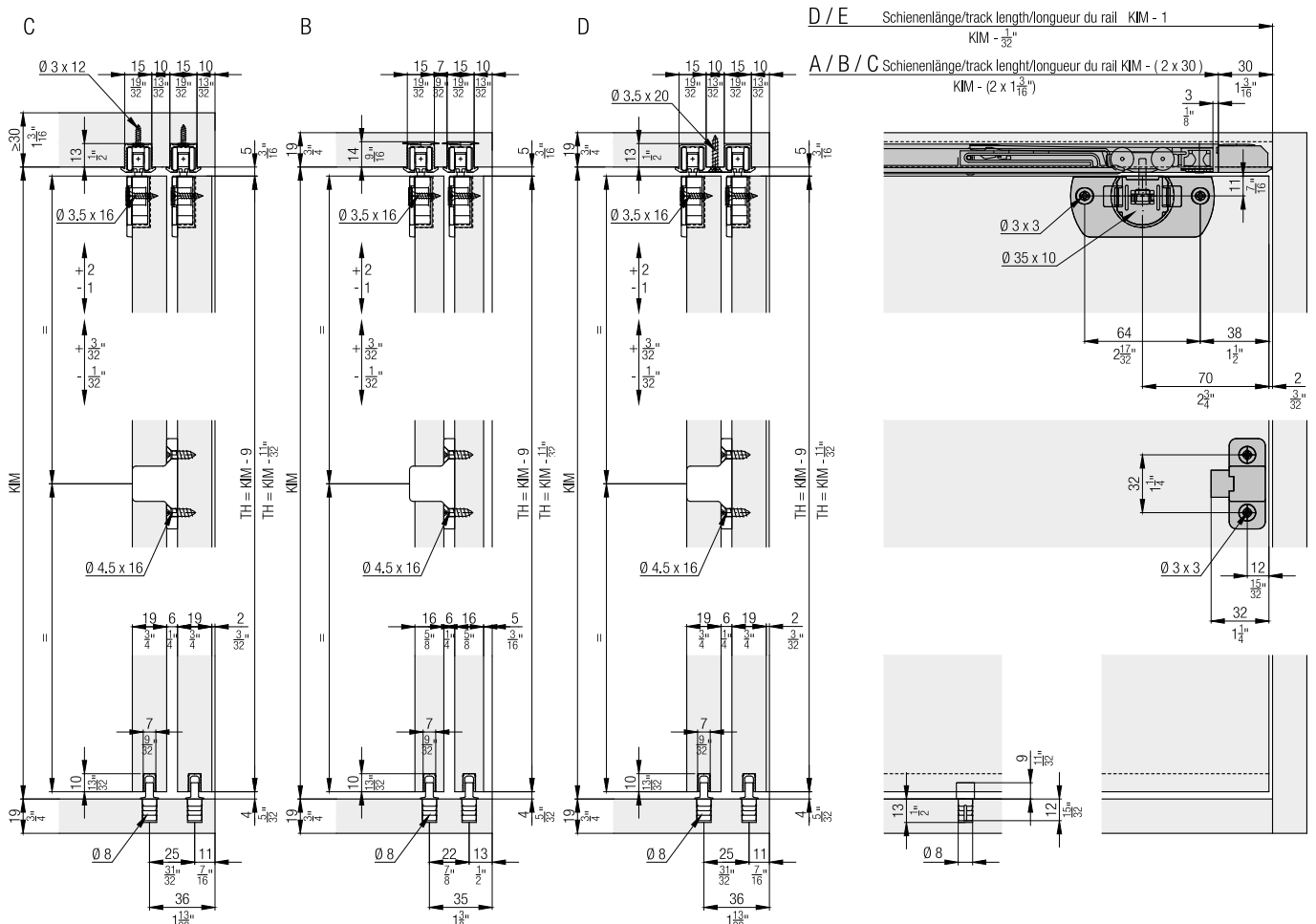



Installation examples



**Set for 2 wooden doors up to 16 kg (35 lbs.),
with height adjustment**

	No.
Hawa Clipo 16 H IS, for 2 doors	053.3220.071

Set consisting of:

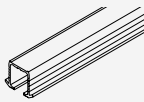
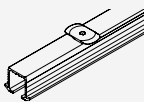
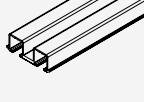

		053.3220.071	No.
	Hawa Clipo 16 H/Hawa Regal 16 C running gear, plastic, anthracite	4	053.3205.071
	Hawa Clipo 16/Hawa Regal 16 C stopper, plastic, gray	2	053.3215.071
	Housing, plastic, anthracite	4	053.0183.001
	Fillister head screw, 3.5x16 mm (5/32"x5/8"), steel, zinc-plated	8	766.6052.100
	Door follower, plastic, anthracite	1	053.3217.071
	Flat countersunk head chipboard screw, 4.5x16 mm (3/16"x5/8"), steel, zinc-plated	2	600.0000.478
	Hawa Clipo 16 H bottom guide, plastic, anthracite	2	053.3214.001

Running tracks

		mm (inch)	No.
	A: Single running track, for glue fixing, aluminum	2,500 (8' 2 7/16")	053.3229.250
		3,500 (11' 5 25/32")	053.3229.350
		6,000 (19' 8 7/32")	053.3229.600
	B: Single running track, with swivel-lug, aluminum (not for hard wood/MDF)	2,500 (8' 2 7/16")	053.3227.250
		3,500 (11' 5 25/32")	053.3227.350
		6,000 (19' 8 7/32")	053.3227.600
	C: Single running track, aluminum, pre-drilled	2,500 (8' 2 7/16")	053.3225.250
		3,500 (11' 5 25/32")	053.3225.350
		6,000 (19' 8 7/32")	053.3225.600
	D: Double running track, aluminum, pre-drilled	2,500 (8' 2 7/16")	053.3226.250
		3,500 (11' 5 25/32")	053.3226.350
		6,000 (19' 8 7/32")	053.3226.600
	E: Double running track, aluminum, anodized, pre-drilled	2,500 (8' 2 7/16")	053.3231.250
		3,500 (11' 5 25/32")	053.3231.350
		6,000 (19' 8 7/32")	053.3231.600

Track end piece set for single running tracks

	No.
Track end piece, for screw fixing, plastic, gray	053.3210.081
Track end piece, with swivel lug, plastic, gray	053.3211.081

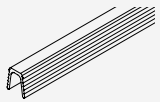

		053.3210.081	053.3211.081	No.
Set consisting of:				
	Track-end piece, for screw fixing, plastic, grey	2		053.3210.001
	Track-end piece, with swivel lug, plastic, grey		2	053.3211.071

Guide tracks

		mm (inch)	No.
	Guide track, groove width 7 mm (9/32"), plastic, anthracite	2,500 (8' 2 7/16")	053.3012.250
		3,500 (11' 5 25/32")	053.3012.350
		6,000 (19' 8 7/32")	053.3012.600

Soft close up to 8/16 kg (17/35 lbs.)

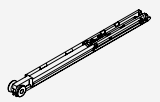
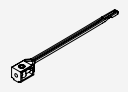

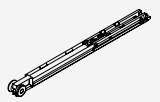
	No.
Soft close Hawa Clipo 16/Hawa Regal C 16, up to 8 kg (17 lbs.)	053.3332.071
Soft close Hawa Clipo 16/Hawa Regal C 16, up to 16 kg (35 lbs.)	053.3332.072

		053.3332.071	053.3332.072	No.
Set consisting of:				
	Damper, up to 8 kg (17 lbs.)	2		053.3330.071
	Trigger, with stopper	2	2	053.3331.071
	Cross recessed pan head screw, 2.2x8 mm (3/32"x5/16"), steel, zinc-plated	2	2	600.0000.482
	Damper, up to 16 kg (35 lbs.)		2	053.3330.072

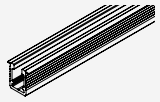

Guide tracks 4-point guidance

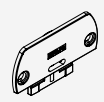
		mm (inch)	No.
	Single guide track, for glue fixing, aluminum, anodized	6,000 (19' 8 7/32")	053.3296.600



Components 4-point guidance

		No.
	Bottom guide Hawa Clipo IS/Hawa Regal C 16, plastic, anthracite	040.3124.071
	Stopper guide track, plastic, grey	053.5094.071

Door centering

		No.		
Door centering, plastic, anthracite, for 2 doors		053.3207.071		
		053.3207.071	No.	
	Housing door centering, plastic, anthracite		2	053.5014.001
	Pin door centering, plastic, anthracite		2	053.0171.001
	Rubber buffer, plastic, grey	1	025.0107.001	

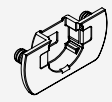
Accessories

		No.
	Housing Hawa Clipo 16, press-fit, plastic, anthracite	083.3009.002
	Track cleaner, plastic, red	040.3142.071

Further installation examples

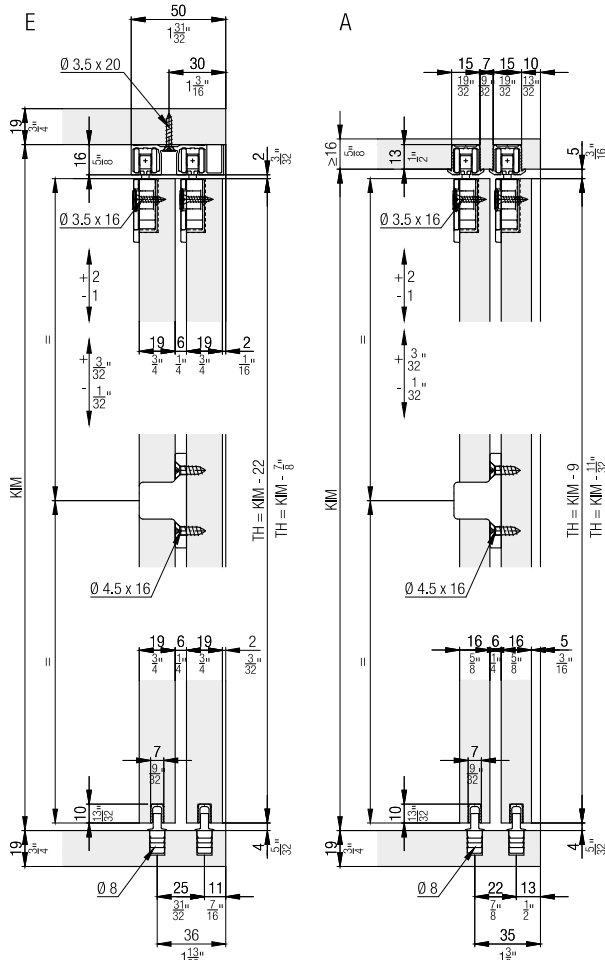

Calculations

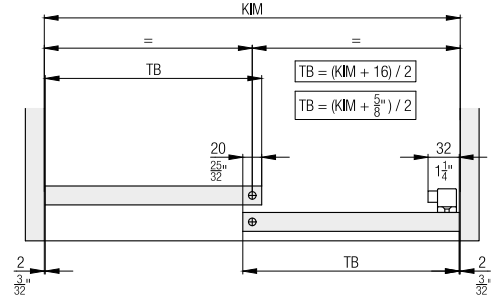

4 point guidance

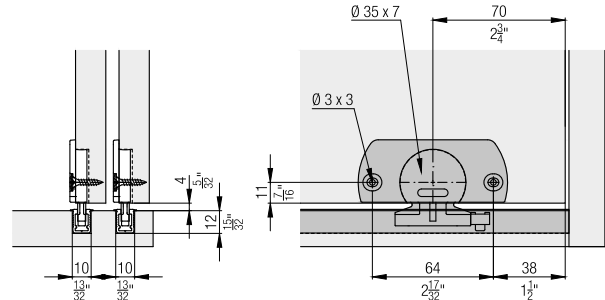

Housing for press-fitting

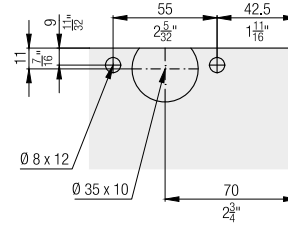

Door centering

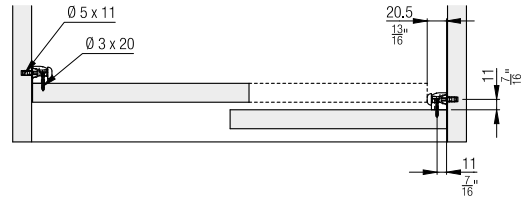

Soft close

	Z ≥	
	1	2
Hawa Clipo 16 H IS	1' 3 ³ / ₈ "	1' 11 ⁵ / ₈ "
Hawa Clipo 16 H MS	1' 5 ¹ / ₄ "	2' 1 ¹ / ₈ "
Hawa Clipo 16 H FS	1' 5 ¹ / ₄ "	2' 1 ¹ / ₈ "
Hawa Clipo 16 HM IS	1' 3 ³ / ₈ "	1' 11 ⁵ / ₈ "
Hawa Clipo 16 GK IS	1' 3 ³ / ₈ "	1' 11 ⁵ / ₈ "
Hawa Clipo 16 GS IS	1' 3 ³ / ₈ "	1' 11 ⁵ / ₈ "
Hawa Clipo 16 GPK IS	1' 3 ³ / ₈ "	1' 11 ⁵ / ₈ "
Hawa Clipo 16 GPPK IS	1' 3 ³ / ₈ "	1' 11 ⁵ / ₈ "

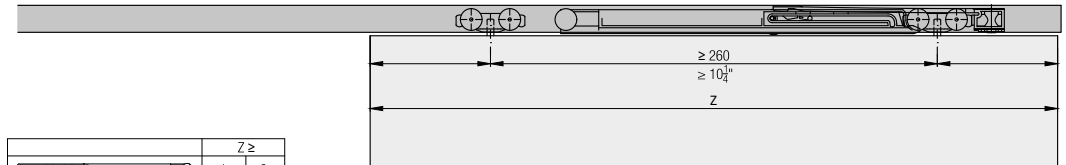

	Z ≥	
	1	2
Hawa Clipo 16 H IS	400	600
Hawa Clipo 16 H MS	438	638
Hawa Clipo 16 H FS	438	638
Hawa Clipo 16 HM IS	400	600
Hawa Clipo 16 GK IS	400	600
Hawa Clipo 16 GS IS	400	600
Hawa Clipo 16 GPK IS	400	600
Hawa Clipo 16 GPPK IS	400	600

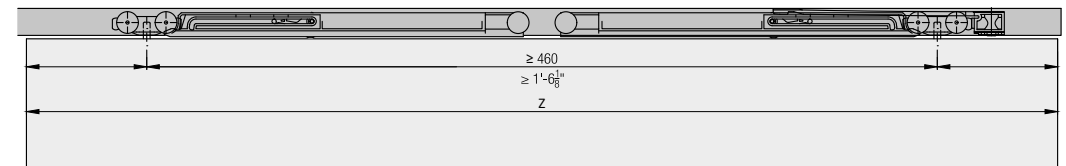

Accessories

– Straightening fitting from page 265

Planning/execution

Further information about the product can be found on www.hawa.com.