

C-500 SERIES BY-PASSING SLIDING DOOR KIT FOR 1-3/4" DOORS

INSTRUCTION SHEET

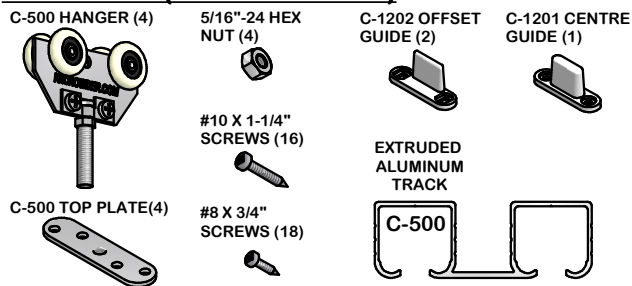

PARTS LIST (FOR 2 DOOR KIT)



SPECIFICATIONS:
 -LOAD CAPACITY: 125 LBS PER DOOR.
 -HEAVY-DUTY PRECISION BALL BEARING WHEELS WITH NYLON TIRE.
 -FEATURES VERTICAL ADJUSTMENT BY THREADED TOP PLATE AND LOCK-NUT.
 -IDEAL FOR MIRROR COVERED AND SOLID CORE DOORS.
 -AVAILABLE IN 2 DOOR, 3 DOOR, AND 4 DOOR KITS.
 -HANGERS ARE AVAILABLE IN STAINLESS STEEL (C-500-SS)

INSTALLATION INSTRUCTIONS

STEP 1
 DETERMINE DOOR SIZE/HEADER HEIGHT BASED ON DIMENSIONS SHOWN IN DETAIL VIEWS AND CLEARANCE REQUIRED BELOW DOOR:
 -MINIMUM OPENING HEIGHT (A) = DOOR HEIGHT + 2-3/4"
 -MAXIMUM OPENING HEIGHT (A) = DOOR HEIGHT + 3-5/8"

STEP 2
 CUT TRACK TO LENGTH. TRACK LENGTH SHOULD BE EQUAL TO FINISHED OPENING SIZE LESS 1/8". INSERT C-500 HANGERS INTO TRACK AND SECURE TRACK TO HEADER WITH #8 X 3/4" SCREWS (6). **NOTE: CLIP SCREWS MUST BE ACCESSIBLE AND FACE SAME SIDE OF OPENING (I.E. INSIDE OF CLOSET).**

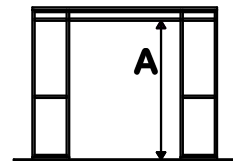

DIMENSION DETAILS:

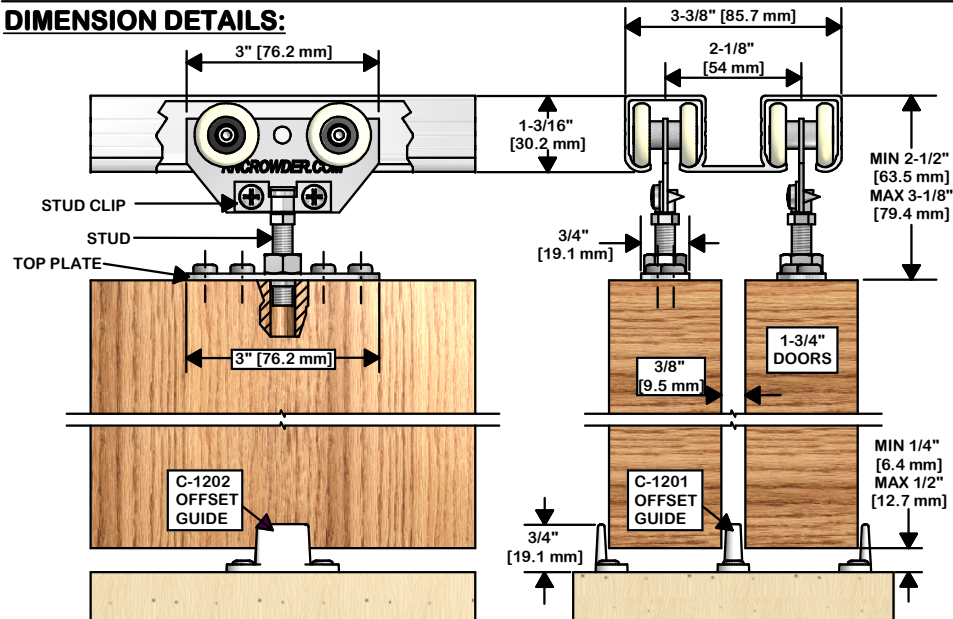

STEP 3
 A) LOCATE CLEARANCE HOLE FOR HANGER STUD 3-1/2" FROM EACH EDGE OF DOOR. DRILL WITH 3/8" BIT AT LEAST 1-1/2" DEEP.
 B) CENTER TOP PLATE OVER HOLE WITH FLAT SIDE UP, MARK SCREW HOLE LOCATIONS AND PRE-DRILL WITH 1/8" BIT AT LEAST 1" DEEP.

STEP 4
 MOUNT TOP PLATES ON DOOR AND SECURE WITH #10 X 1-1/4" SCREWS (4 PER TOP PLATE).

STEP 5
 USING A PHILLIPS SCREWDRIVER, REMOVE THE CLIP SCREWS ON HANGER TO REMOVE BOLT. PLACE ONE 5/16"-24 HEX NUT ON BOLT AND SCREW BOLT INTO TOP PLATE ON THE DOOR.

STEP 6
 PREPARE DOOR FOR INSTALLATION OF OPTIONAL PRODUCTS SUCH AS GUIDE CHANNELS, CUP PULLS, DOOR LOCKS, ETC., AS REQUIRED. INDIVIDUAL INSTRUCTIONS ARE PROVIDED WITH THE RESPECTIVE PRODUCT.

STEP 7
 LOCATE C-1201 CENTRE AND C-1202 OFFSET GUIDES AND SECURE TO FLOOR WITH #8 X 3/4" SCREWS (6). IT MAY BE NECESSARY TO INSTALL DOOR(S), DETERMINE GUIDE LOCATION, REMOVE DOOR(S) AND THEN SECURE GUIDES TO FLOOR. IF USING OPTIONAL C-201 OR C-914 GUIDE CHANNEL, INSTALL C-200 OR C-913 GUIDE IN PLACE OF THE C-1202 GUIDES. IF USING OPTIONAL C-202 GUIDE THRESHOLD, INSTALL C-200 GUIDES ON DOORS AND C-202 GUIDE THRESHOLD ON FLOOR.

STEP 8
 LOCATE DOOR UNDER HANGERS AND LIFT TO PLACE BOLTS INTO HANGER SLOT AND SECURE WITH THE CLIPS AND SCREWS PREVIOUSLY REMOVED IN STEP 5. DO NOT OVER TIGHTEN SCREWS.

STEP 9
 ADJUST DOOR HEIGHT AND PLUMB VIA HEX SECTION OF BOLT WITH 3/8" WRENCH. LOCK ADJUSTMENT BY TIGHTENING HEX NUT AGAINST TOP PLATE. RE-TIGHTEN CLIP SCREWS.

STEP 10
 IF USING OPTIONAL C-100 DOOR STOP, INSTALL IN TRACK AT REQUIRED LOCATION.

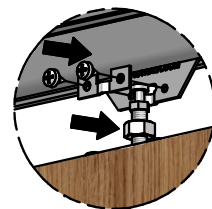
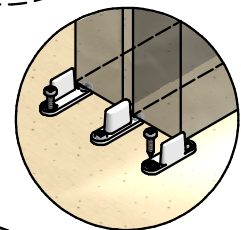
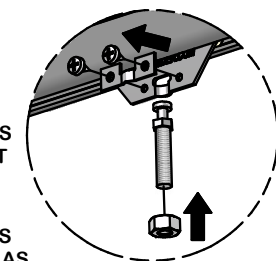
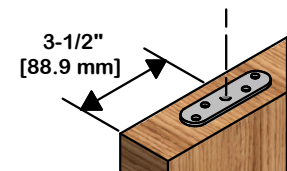
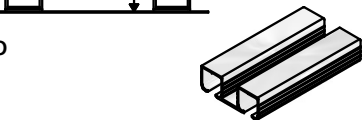

OPTIONAL PRODUCTS

GUIDE SYSTEM:

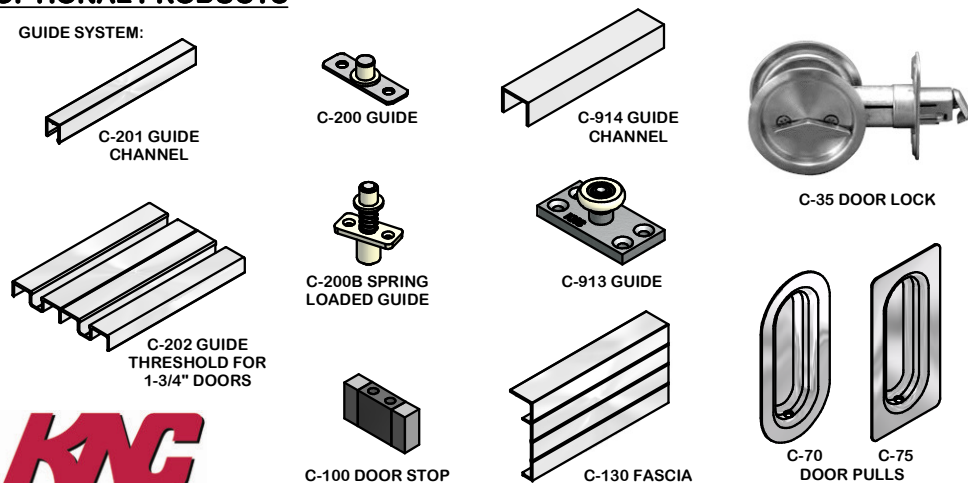

K.N. CROWDER MFG. INC.
 1220 BURLOAK DRIVE
 BURLINGTON, ONTARIO, CANADA, L7L 6B3
 TELEPHONE: 905-315-9788 - FAX: 905-315-8090
 TOLL FREE FAX: 1-800-567-0123

K.N. CROWDER INC.
 210 EIGHTH STREET SOUTH
 LEWISTON, NEW YORK, U.S.A. 14092
 TELEPHONE: 1-716-754-8247
 TOLL FREE FAX: 1-800-567-0123

WEBSITE: www.kncrowder.com -- E-MAIL: customerservice@kncrowder.com