

Changes to Wilsonart® Solid Surface manual dated 09/2018:

Page 7	Revised Sheet Selection Process information Additional FAB TIP
Page 12	Additional FAB TIP
Page 16	Additional FAB TIP
Page 17	Additional FAB TIP
Page 22	Revised illustrations
Page 23	Additional FAB TIP
Page 24	Additional FAB TIP
Page 27	Revised and additional illustrations
Page 28	Additional FAB TIP Revised FAB TIP
Page 29	Revised and additional FAB TIPS
Page 32	Revised information about 9mil tape
Page 37	Additional FAB TIP
Page 44-45	Additional pattern information

CONTENTS

CHAPTER I	Introduction	4
CHAPTER II	Safety	5
CHAPTER III	Handling	7
CHAPTER IV	Tools	8
CHAPTER V	Job Planning	12
CHAPTER VI	Deck Seams	18
CHAPTER VII	Drop Edges	23
CHAPTER VIII	Sinks	28
CHAPTER IX	Cutouts	30
CHAPTER X	Backsplash	33
CHAPTER XI	Thermoforming	35
CHAPTER XII	Finishing	36
CHAPTER XIII	Installation	38



Any fabrication procedure or technique not contained within the Wilsonart® Solid Surface Fabrication Manual will not be recognized by Wilsonart, LLC as an approved method of fabrication. Deviations from these techniques must be approved in writing by a Wilsonart Representative.



General Safety:

Safety is a critical concern for any shop and key to a successful business. The following safety rules should be incorporated into your safety program to help prevent an accident. Safety training, knowledge, product use and environment are the responsibility of the facility owner and the shop employees.

CAUTION: Always follow product, equipment and/or tool manufacturer's recommendations and instructions carefully.

- Read directions carefully before fabricating/installing Wilsonart® Solid Surface.
- Read and follow the instruction manual before operating the different tools.
- Keep all guards in place and in working order.
- Ensure all tools are properly grounded. Never remove the third prong.
- Keep work area clean, uncluttered and well lit.
- Don't use electric power tools in a damp or wet work area.
- Keep visitors at a safe distance from the work area.
- Use the right tools. Don't force a tool or attachment to do a job it was not designed to perform.
- Always use safety glasses or approved eye protection and/or face shield, ear/noise protectors and safety shoes. (FIG. 5A & 5B)
- Wear the proper apparel, no loose clothing or jewelry.
- Secure all work with the proper clamp or vise to a stable work surface.
- Don't overreach. Keep proper footing and balance at all times.
- Maintain tools in top condition. Disconnect tools before servicing and when changing accessories such as blades, bits, cutters, etc.
- Keep and use denatured alcohol, adhesives and materials in a safe, ventilated place.
- Dust collection should be used when cutting, routing and sanding. Tools should be used with dust collection at all times.



Figure 5A



Figure 5B

Wilsonart® Hard Surface Adhesive:

- Wilsonart® Hard Surface Adhesive is for professional use only. Always follow the manufacturer's recommendations and instructions carefully. (FIG. 6A)
- Warning: This seam kit contains the following hazardous ingredients: Methyl Methacrylate, Benzoyl Peroxide, and Dibutyl Pathlate. Avoid prolonged breathing of vapors. Use only in a well ventilated area. Keep out of reach of children. Eye protection is always recommended. Motors and other equipment used in the fabrication and installation process must be UL labeled explosion proof.
- For further information refer to Wilsonart® Hard Surface Adhesive Material Safety Data Sheet available on request. Contact your local distributor or call 1-800-433-3222 for immediate response.



Figure 6A

FAB TIP:

- For Wilsonart Solid Surface hard seam design color chart, refer to www.wilsonart.com

Handling:

Carry Wilsonart® Solid Surface sheets vertically to minimize flexing.

Storage:

- Store Wilsonart® Solid Surface sheet goods flat on pallets or other suitable racks. (FIG. 7A)
- Store Wilsonart® Sinks in their original shipping boxes until ready to install. (FIG. 7B)
- Store Wilsonart® Hard Surface Adhesive in cool, stable refrigeration unit. The optimum temperature should be between 40° F and 60° F.
- The shelf life of the seam kits will be greatly increased by refrigerated storage. (Do Not Freeze)
- See Technical Data Sheet for additional information.



Figure 7A

Inspection:

Every effort has been made to supply high quality materials, free of defects. However, as the fabricator, you must conduct a final (pre-cut) inspection for manufacturing defects or damages to continue the quality control process prior to fabrication.



Figure 7B

Sheet Selection Process:

Wilsonart® Solid Surface sheets are color matched by lot numbers only.

Lot number is located on edge of sheet material.

To ensure color match be sure to use the same lot number.

FAB TIP:

Always review movement design at seams and edge profiles because pattern may vary

The following suggested tool list is only a minimum requirement for professional and successful Wilsonart® Solid Surface fabrication.

Various woodworking and specialized Solid Surface fabrication tools are available in the market today.

Stationary Tools:

- Table or Panel Saw
- Miter (“Chop”) Saw
- Triple Chip Carbide Saw Blades

Hand & Power Tools:

- Routers (FIG. 8A)
 - 3¼ HP with ½” (13mm) collet
 - 3¼ HP Plunge base with ½” (13mm) collet
 - 1½ -2½ HP with ½” (13mm) collet (edge details)
- General Router Bits
 - ½” (13mm) Straight cut
 - ½” (13mm) Bottom bearing flush trim bit
 - 1” (25.4mm) Top bearing flush trim bit
 - Various profile bits
- Random Sanders (FIG. 8B)-Random Orbital
 - Dust collection system (suggested)
 - Sanding Disks
 - Mirka Abralon® pads
- Straight Edges (Phenolic or Aluminum)
- Clamps (FIG. 8C)
- Bowl Bits



Figure 8A



Figure 8B



Figure 8C

Contact 800-433-3222 or Wilsonart Technical Service Department for recommended bits.

Tools Not Recommended:

- Jigsaws - Rout all cutouts. (FIG 9A)
- Auger type drill bits – Use hole saw/router for larger holes. (FIG. 9B)
- Belt Sanders – Do not use belt sanders at seam areas. (FIG. 9C)
- ATB (Alternate Top Bevel) or ripping saw blades. Use only triple chip or Solid Surface cutting blades. (FIG. 9D)



Figure 9A



Figure 9B



Figure 9C



Figure 9D

TOOL MANUFACTURERS

Stationary Tools:

Powermatic 1-800-274-6848 www.powermatic.com

Delta 1-800-223-727
www.deltamachinery.com

Holz-Her 1-704-587-3400
www.holzher.com

Striebig 1-781-585-4364
www.csaw.com

Hand Tools - Routers, Sanders, Bits, etc:

Porter Cable 1-888-848-5175
www.portercable.com

Beaver Tools 1-800-365-6677
www.beavertools.com

Router Bits:

Southeast Tool Inc 877-465-7012
www.southeasttool.com

Velepec 1-800-365-6636
www.velepectools.com

Wesley Tools, Ltd.
1-800-397-6867
www.wesleytools.com

Amana Tool 1-800-445-0077
www.amanatool.com

Sanding Equipment:

Gem Sander 1-800-447-4436
www.gem-industries.com

Dynabrade 1-716-631-0100
www.dyabrade.com

Master Power 1-866-557-8316

Festool 1-800-423-3531
www.festoolusa.com

Surcare 1-800-669-5519
www.surcare.com

Sandpaper/Finishing Pads:

3M Scotch-Brite & Trizact
1-800-742-9546
www.3m.com

Mirka 1-800-843-3904
www.mirka-usa.com

Norton 1-800-446-1119
www.nortonabrasives.com

Sia 1-800-459-3534
www.sia-abrasives.com

Pipe and Bar Clamps:

Bessey 1-800-828-1004
www.americanclamping.com



TOOL MANUFACTURERS

Recommended Saw Blades:

Amana Tool 1-800-445-0077
www.amanatool.com

Leitz 1-800-253-6070
www.leitz.com

FS Tool 1-800-387-9723
www.fstoolcorp.com

Guhdo 1-800-544-8436
www.guhdo.com

Forrest 1-800-733-7111
www.forrestsawblades.com

Misc. Tools:

Betterley Industries
1-800-871-7516
www.betterleytools.com

DeWalt 1-800-433-9258
www.dewalt.com

Specialty Tools 1-800-669-5519
www.specialtytools.com

Dustless sanding system

Fein Power Tools 1-800-441-9878
www.feinus.com

Specialized Solid Surfacing tools

The Pinske Edge 1-800-874-6753
www.pinske-edge.com

Fabrication tools

Align-Rite Tool Co. 1-888-624-1942
www.alignritetool.com

Straight edge

A.M.P.S. 1-800-669-5519
www.ampsedge.com

Vacuum base seam leveler/clamps

Perfect Seam 1-770-463-8321
www.omnicubed.com

Vacuum base seam clamps

Wood's Power Grip Co. 1-800-548-7341
www.powergrip.com

Dust containment

Zip Wall 1-800-718-2255
www.zipwall.com

Adhesive dispenser repair parts

Conprotec Inc. 1-603-893-2727
www.mixpac.com

Sink Setter Brackets/Easy Leveling Shelf and Counter Bracket

Sink Setter at Precision Works 1-714-847-3396
www.sinkset.com

Support Products

Karran 866-452-7726
www.karran.com



FAB TIPS:

- Deck Seams or Drop Edges: **See pages 42-44 for recommendations when using movement designs.** Always review movement design at seam locations and edge profiles because pattern design may vary.
- Thermoforming: **See pages 42-44 for list of designs approved for Thermoforming.**
- Refer to the Thermoforming Section when forming or bending Wilsonart Solid Surface. Certain Wilsonart patterns are not recommended for the Thermoforming process. **(See pages 42-44 for listing)**
- Spot heating or cold bending is not approved and will introduce internal stress into the product.
- Do not use lacquer thinner, acetone or other solvents on Wilsonart® Solid Surface material.
- Colored or printed towels can leave a residue which will contaminate the seam material and cause a weak or stained bond line.
- All edges should be sanded smooth and free of sharp corners and kerf marks which result in stress points.



Wilsonart® Solid Surface Countertop Layout Conventional Seams Locations

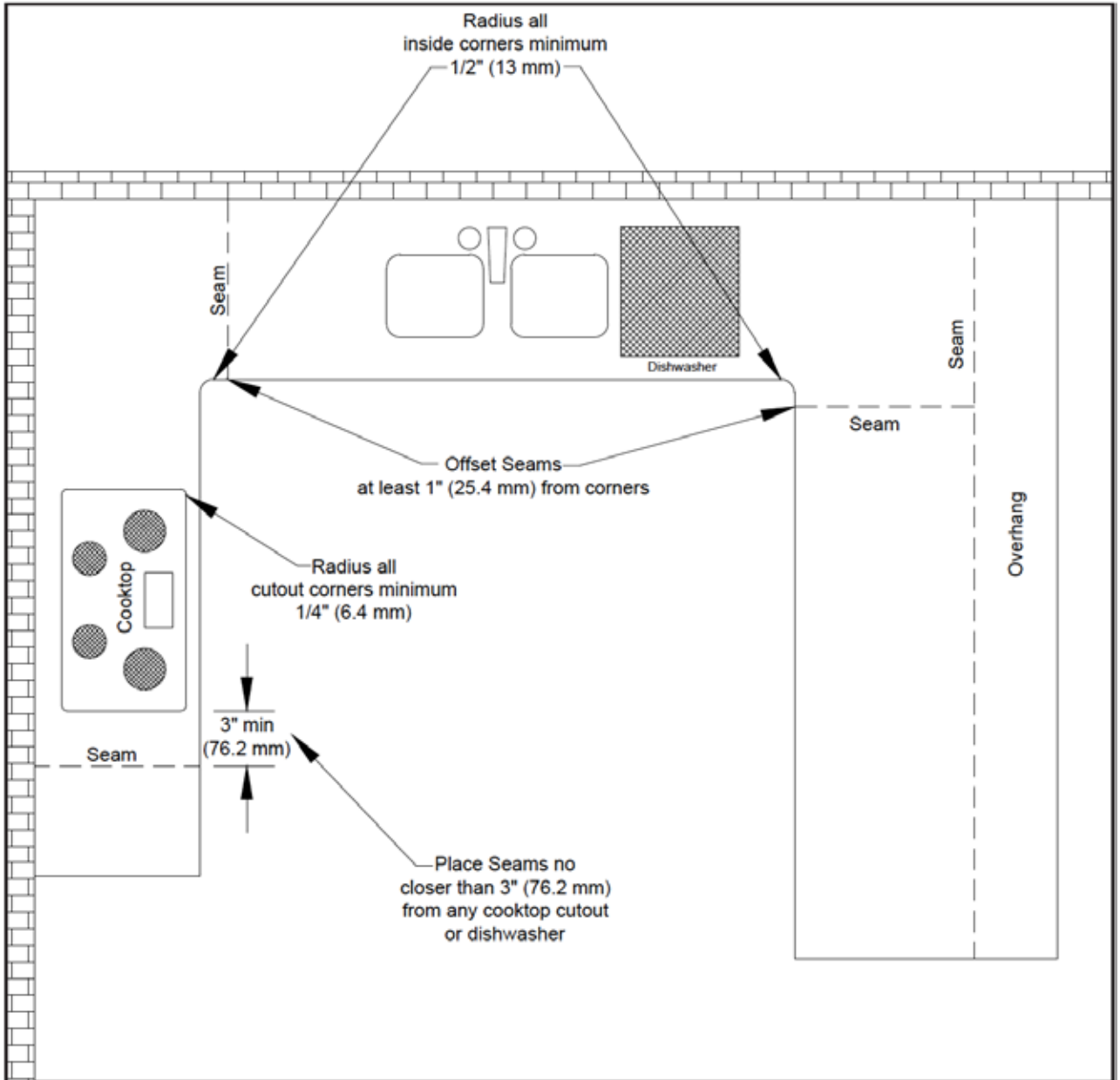

Figure 13A

Wilsonart® Solid Surface Countertop Layout PT Seams Locations. Ideal for V-Grooving Tops & Movement Patterns

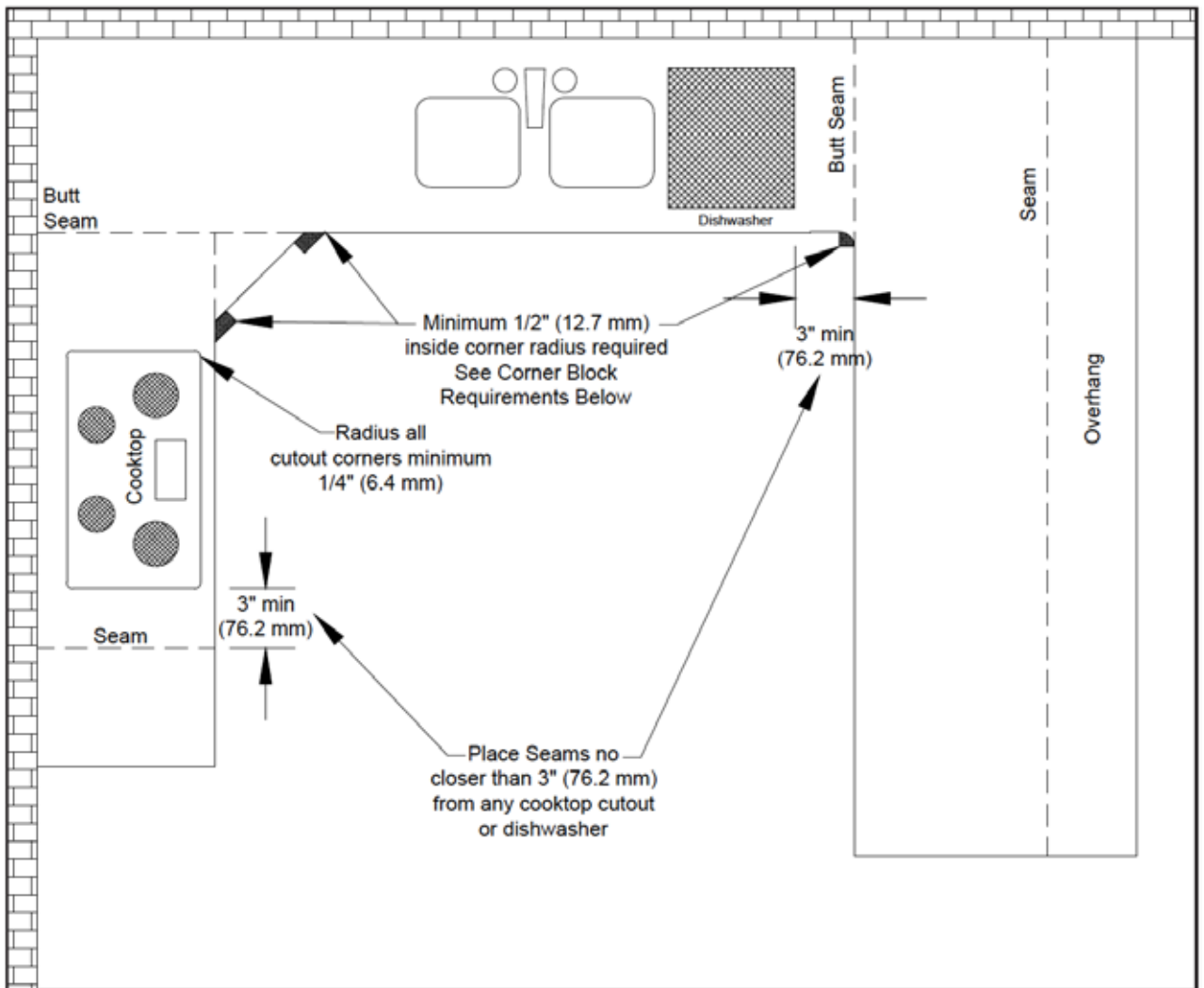

Figure 14A

FAB TIP:

Always review movement design at seams and edge profiles because pattern may vary



Wilsonart® Solid Surface Countertop Layout 45° Seams Locations

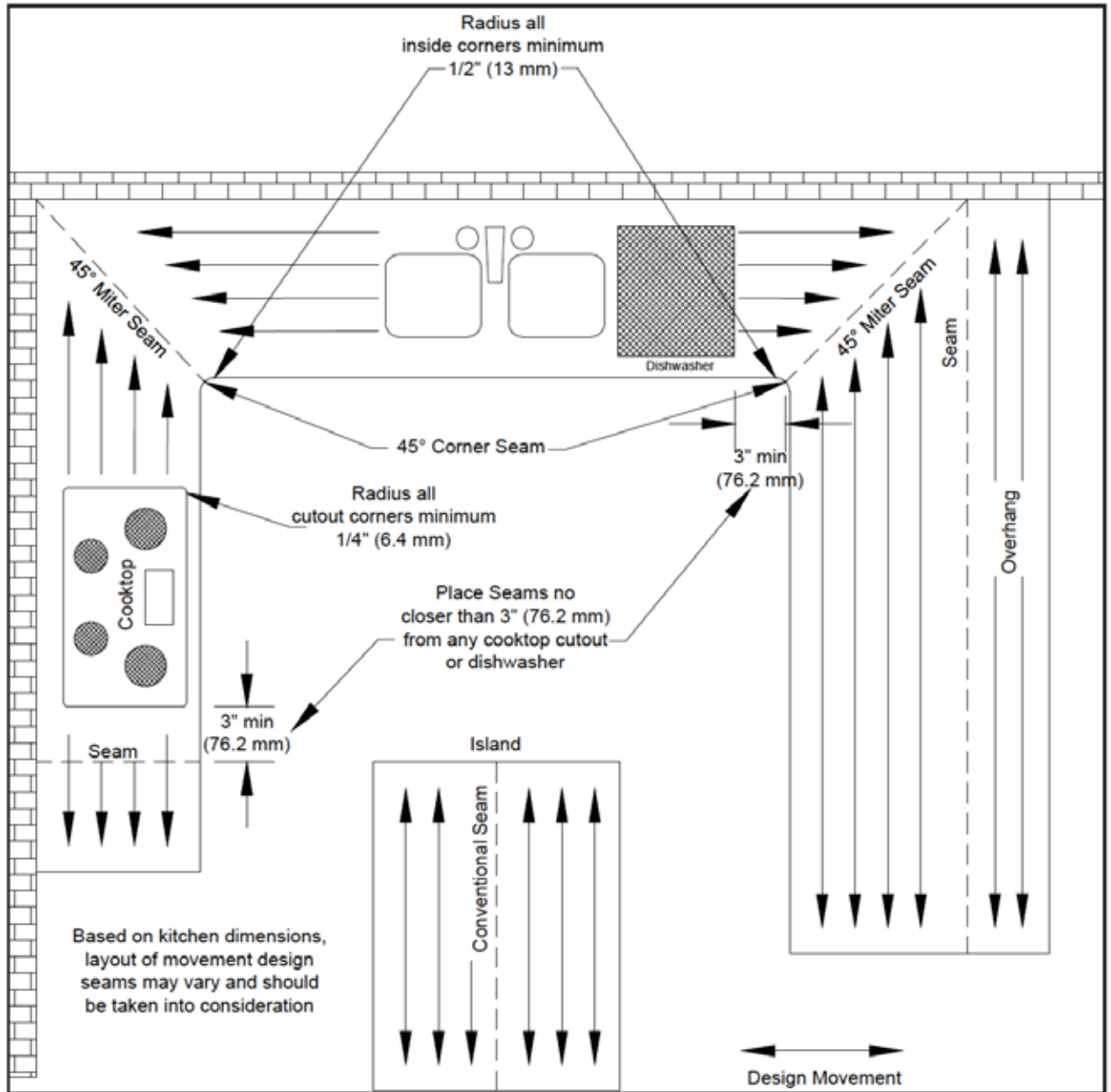

Figure 15A

FAB TIP:

Always review movement design at seams and edge profiles because pattern may vary



Wilsonart® Solid Surface Countertop Layout PT Butt Seams Movement

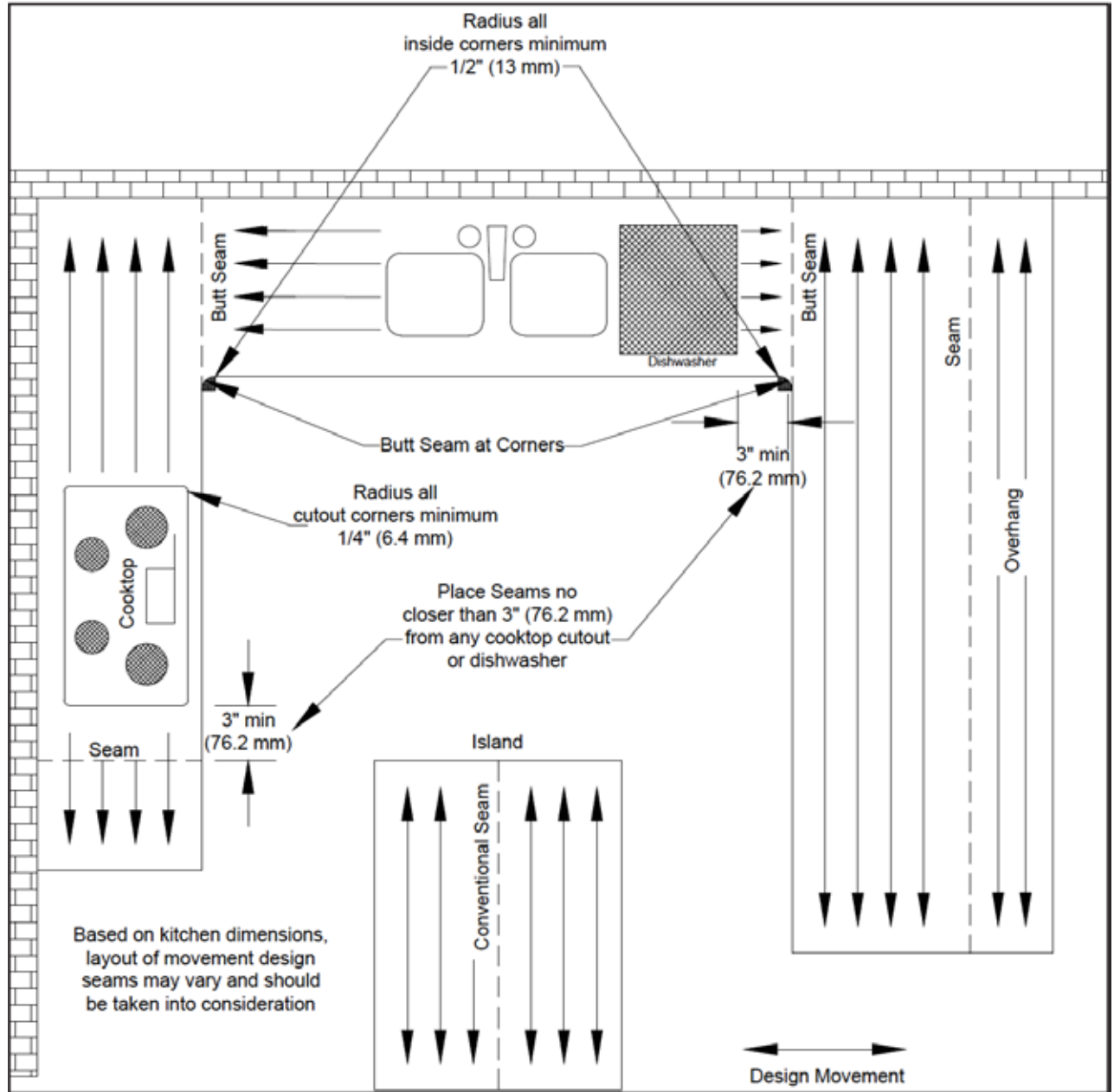

Figure 16A

FAB TIP:

Always review movement design at seams and edge profiles because pattern may vary



Wilsonart® Solid Surface Countertop Layout Conventional Seams Movement

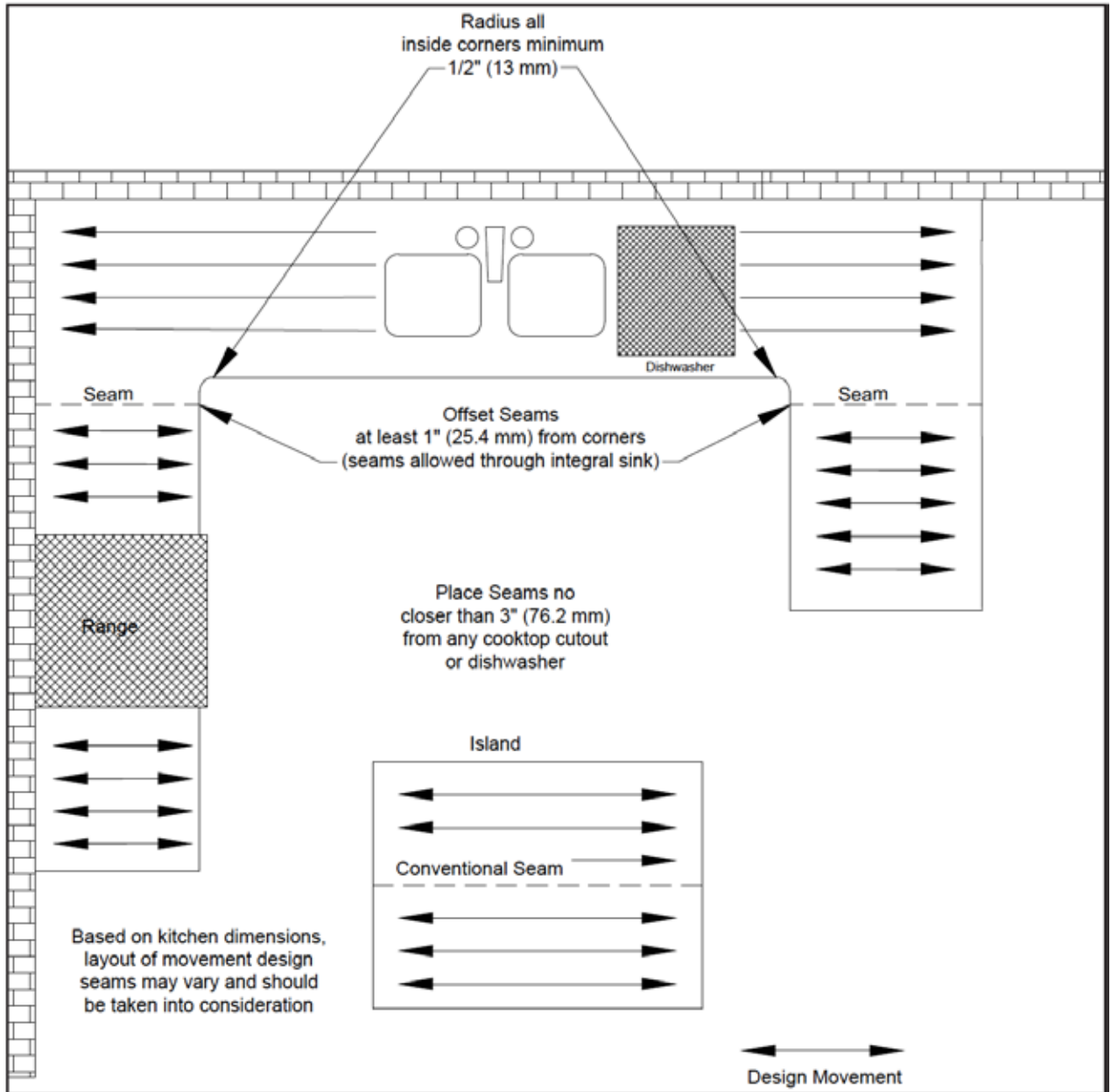

Figure 17A

FAB TIP:

Always review movement design at seams and edge profiles because pattern may vary



Deck Seams—Conventional

- Machine both edges to be seamed. (FIG. 18A)
- Seams should fit tightly when dry fitted.
- Place a release material (such as clear packing tape) under the seam to prevent contamination of deck seam.
- Thoroughly clean areas to be seamed with denatured alcohol using clean white shop rag.
- Position sheets to be seamed 1/8" (3.0mm) to 3/16" (4.8mm) apart.
- Prepare clamping materials.
- Prepare seam kits.
 - Purge cartridge and tip to ensure proper mixture of adhesive.
- Fill the seam to 1/2 full.
 - Damming the ends will make this easier.
- Slide the sheets together - make sure there is adhesive squeeze-out along entire seam. Clamp the seam together using bar or spring clamps. (FIG. 18B)
- DO NOT OVERTIGHTEN clamps.
 - Over tightening will cause starved, weak seams.
- Remove adhesive squeeze-out with router on "skis," surface leveler, or random orbital sander. (FIG. 18C)
 - Do not scrape, chisel or use belt sander on seam.
- All seams must be reinforced with a 4" (101.6mm) wide Wilsonart® Solid Surface seam support adhered to the back of the panel. (FIG. 18D)
- 45° seams required 5" wide Wilsonart Solid Surface seam support (see page 20)
- Reinforcement strip must cover length of seam.
- Overlap seam support 2" (50.8mm) on each side.
- Ensure complete adhesive coverage.
 - Sand the finished seam to job specifications. (See Finishing Section)



Figure 18A

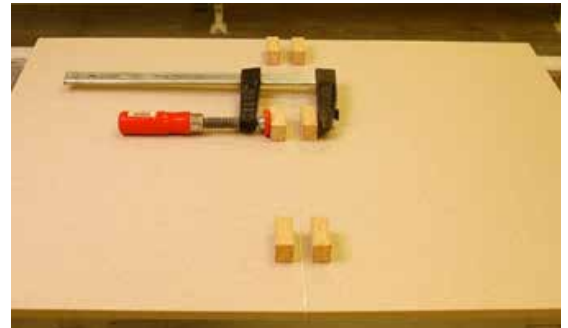

Figure 18B



Figure 18C



Figure 18D

Deck Seams—PT Seam

This method can be used with miter fold, vertical and stacked edges.

- Machine all edges to be seamed. (FIG. 19A)
- Thoroughly clean areas to be seamed with denatured alcohol using clean white shop rag.
- Prepare clamping equipment.
- Prepare seam kit.
 - Purge cartridge and tip to ensure proper mixture of adhesive.
- Apply two 3/16" (4.8mm) beads of adhesive on the edge of one panel to be seamed. (FIG. 19B)
 - Apply sufficient adhesive which will cover entire drop edge and allow squeeze-out along entire seam.
- Clamp the seam together. (FIG. 19C using Paralign Clamp System)
- Optional Seaming packages available (FIG. 19D)
- DO NOT OVERTIGHTEN clamps.
 - Over tightening will cause starved, weak seams.

FAB TIP: 90° seam with the Movement Design Series will create visual inconsistencies.



Figure 19A



Figure 19B

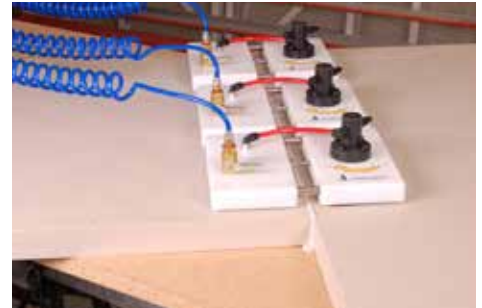

Figure 19C

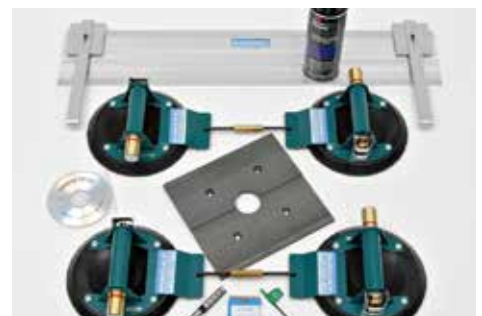

Figure 19D

DECK SEAMS

- Adhere a Wilsonart® Solid Surface block into the inside corner and clamp in place. Block must cover entire length of seam from top of deck to bottom of drop edge. (FIG. 20A)
 - See page 26 for minimum requirements.
 - Squeeze-out is required on both top and bottom of the seam and all sides of the corner block.
- Remove adhesive squeeze-out with router on “skis,” surface leveler, or random orbital sander. (FIG. 20B)
 - Do not scrape, chisel or use belt sander on seam.
- Rout radius at inside corner. See page 27 for minimum requirements. (FIG. 20C)
- To accommodate face frame installs, a 1” minimum seam thickness is required over cabinet base, thus eliminating notching the cabinet base. (FIG. 20D)
- Sand the finished seam to job specifications. (See Finishing Section)



Figure 20A



Figure 20B



Figure 20C

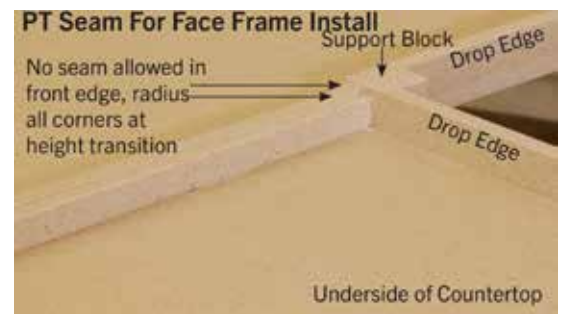

Figure 20D

Deck Seams—45° Seam

This method is recommended to be used for movement or directional designs. Conventional 45° seams are the preferred method for seaming, allowing the pattern movement to continue throughout the application and flow in similar direction through the angle or corner.

- Oversize the width of both sections being seamed by a minimum of 1" (25.4mm) on each section.
 - To be based on finished countertop dimension for a finished standard 25" (635.0mm) countertop depth - i.e. 26" (660.4mm).
 - This will allow for adequate material once corner and profile are machined and allow for edge detail seams distance from the inside corner.
- Machine both edges to be seamed.
- Seams should fit tightly when dry fitted.
- Place a release material (such as packing tape) under the seam to prevent contamination of deck seam.
- Thoroughly clean areas to be seamed with denatured alcohol using clean white shop rag.
- Position sheets to be seamed 1/8" (3.0mm) to 3/16" (4.8mm) apart.
- Prepare clamping materials.
- Prepare Wilsonart® Hard Surface adhesive seam kits.
 - Purge cartridge and tip to ensure proper mixture of adhesive.
 - Fill the seam to ½ full.
 - Damming the ends will make this process easier.
 - Slide the sheets together. Make sure there is adhesive squeeze-out along the entire length of seam.
- Clamp the seam together using selected clamping process; wood blocks or suction cups with spring clamps, bar clamps and/or other seaming system.
- Do not overtighten clamps as it can cause weak and starved seams.
- Remove fully cured hard surface adhesive squeeze-out with surface leveler, orbital sander or router on skis.
- Do not remove hard seam adhesive with scraper, chisel, block planer or belt sander.



Deck Seams—45° Seam

- All 45° seams in the inside corner must be reinforced with a 5" (127.0mm) wide solid surface seam support (scab) adhered with Wilsonart® Hard Surface adhesive. (Fig. 22A)
- The seam support must cover the entire length of seam, front to back.
- Seam support must extend passed the front inside corner and be able to receive the first edge strip stacked on both sides of the inside corner. (Fig. 22B)
- Overlap seam support 2.5" (63.5mm) on each side.
- Ensure complete adhesive coverage.
- Radius all inside corners minimum 1/2" (13mm) (Fig. 22C & 22D)
- Sand the finished seam to job qualifications. (See Finishing Section)
- Solid substrate support is required for all 45° seams at inside corner area only.
- Must extend past first cabinet support on both sides of inside corner.



Figure 22A



Figure 22B



Figure 22C



Figure 22D

Drop Edges - Stacked

FAB TIP: Drop edges with the Movement Design Series will create visual inconsistencies. See important note below.

- See pages 42-44 for recommended drop edge patterns
- Dry fit edge strips and fasten hot melt blocks. (FIG. 23A)
- Clean surfaces to be seamed thoroughly with denatured alcohol and clean white shop rag.
- Purge cartridge and tip to ensure proper mixture of adhesive.
- Apply Wilsonart® Hard Surface Adhesive and clamp with spring clamps at 2"-3" (50.8-76.2mm) intervals (FIG. 22B)
- Make sure there is adequate glue squeeze-out along entire seam, checking carefully for voids.
- Do not sandwich other materials (wood, metal, laminate, etc.) between Wilsonart® Solid Surface edges. Use these type of inlays in a routed groove.
- Flush trim drop edge. (FIG. 23C)
- Rout requested edge profile.

IMPORTANT NOTE

When using designs with movement - it is important to understand the visual variances that will occur when using stacked and vertical edges. These variations will create variances throughout the length of the drop edge. These variances are not a product issue but inherent of the product design. When using the stacked or vertical method, be aware of variances from part-to-part. V-groove/miter folding methods are recommended when applicable. Whether the variance is subtle or significant, there will be a variance on the movement designs.



Figure 23A



Figure 23B



Figure 23C

Drop Edges - Vertical

FAB TIP: Drop edges with the Movement Design Series will create visual inconsistencies. See important note below.

- See pages 42-44 for recommended drop edge patterns
- Wilsonart® Solid Surface Solids - stacked and rebated vertical edge (FIG. 24A-24C)
- Wilsonart® Solid Surface Particulates - vertical drop suggested with a 1/16" rebate. (FIG. 24A-24C)
 - Larger particulates require rebated edge option
- Wilsonart® Solid Surface Movement Designs (FIG. 24A-24C)
- V-groove/miter recommended, other options see important note below.

Vertical Edge Option

- Inspect the edge of the Wilsonart® Solid Surface sheet for chip distribution variation.
- Dry fit edge strips.
- See both edges options below for remaining steps.

IMPORTANT NOTE

When using designs with movement - it is important to understand the visual variances that will occur when using stacked and vertical edges. These variations will create variances throughout the length of the drop edge. These variances are not a product issue but inherent of the product design. When using the stacked or vertical method, be aware of variances from part-to-part. V-groove/miter folding methods are recommended when applicable. Whether the variance is subtle or significant, there will be a variance on the movement designs.

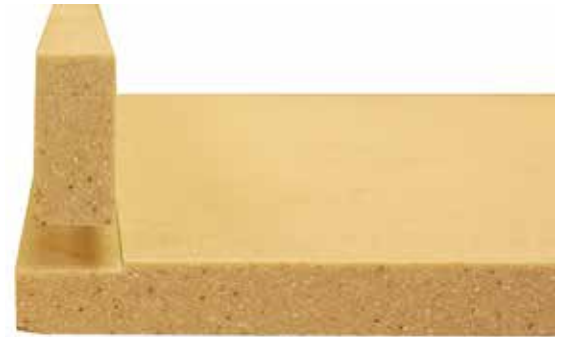

Figure 24A

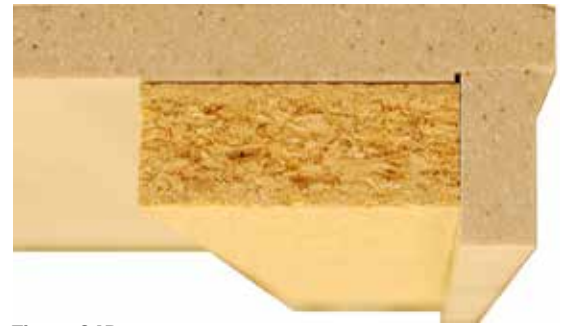

Figure 24B



Figure 24C

Rebated Vertical Edge Option

- Using a bottom bearing rabbeting bit or a router with a straight edge, rout a 1/16" deep by 9/16"-5/8" wide rebate into the bottom side of the sheet.
 - Amana, Superabbet™ part number 4936
- For a Bull Nose, route a 1/16" deep by 1" wide rebate to accept a double vertical stack. (FIG. 25A)
 - Pinske Rabbeting Solutions
(See pages 9 & 10 for details)



Figure 25A

All Edge Options

- Thoroughly clean surfaces with clean, white shop rag and denatured alcohol.
- Purge cartridge and tip for proper adhesive mixture.
- Apply Wilsonart® Hard Surface Adhesive and clamp with spring clamps at 2"-3" (50.8-76.2mm) intervals.
- Make sure there is adequate glue squeeze-out along entire seam, checking carefully for voids.

IMPORTANT NOTE

When using designs with movement - it is important to understand the visual variances that will occur when using stacked and vertical edges. These variations will create variances throughout the length of the drop edge. These variances are not a product issue but inherent of the product design. When using the stacked or vertical method, be aware of variances from part-to-part. V-groove/miter folding methods are recommended when applicable. Whether the variance is subtle or significant, there will be a variance on the movement designs.

Drop Edges - Miter Fold

- Wilsonart suggests Miter Fold Drop Edge for Wilsonart movement patterns:
 - See pages 42-44 for recommended miter fold edge colors.
- Place Wilsonart® Solid Surface face down on a solid, flat work surface.
- Remove corner block and trim hinge tape.
- Clean miter area thoroughly with denatured alcohol and clean, white shop rag.
- Apply a 1/8" bead of Wilsonart® Hard Surface Adhesive in the entire length of the miter fold seam. Also apply a 1/8" bead at one corner to be folded. (FIG 26A)
- Fold up drop edge and clamp into one place. Cam action clamps are suggested. (FIG. 26B)
- Clamps should be within 2" (50.8mm) from each corner and located every 12" (304.8mm).
- Place clamps 1/4" (6.4mm) above the face of the panel to ensure proper pressure.

FAB TIP: Once drop edge is folded into place, do not allow the edge to separate from the deck. If this occurs, reapply seam adhesive.

- Fold up the end caps and secure in place with spring clamps or 3 way clamps.
- Clamps should be placed every 2" (50.8mm). (FIG. 26C)
- Place 3 way clamps 1/4" (6.4mm) above the face of the panel.
- Adhesive squeeze-out is required along entire length of seam and at all corners.
- Allow seam adhesive to cure completely before machining.



Figure 26A



Figure 26B



Figure 26C

Inside Corners

- Inside corners are subject to higher stress and therefore, require special reinforcement.
- One of the following reinforcement procedures must be used:
 - Interlocking Corner Block Method: minimum 3" (76.2mm) x 3" (76.2mm) blocks or greater (FIG. 27A)
 - Interlocking Vertical Strips Method: Corner blocks (FIG. 27B)
- Inside corner on a 45° seam requires seam support interlocking block method (Fig 27B) or corner block method (Fig. 27A). Drop edge seams must be staggered and interlocking.
- The finished inside corner must be routed to a minimum 1/2" (13mm) radius. However, a larger radius is better.

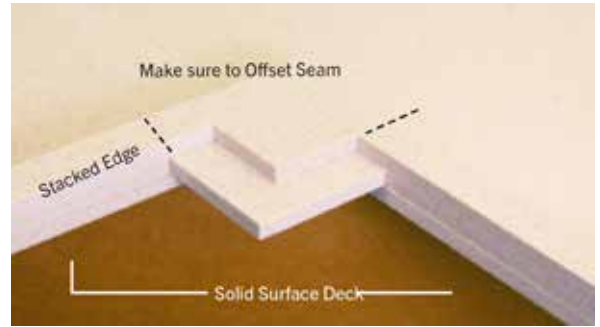

Figure 27A

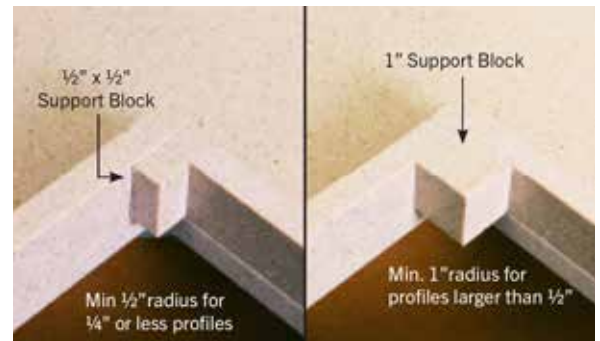

Figure 27B

Outside Corners

- This method may be used up to 9" radius, requiring 1–3 strips placed on the angle. (FIG. 27C & 27D)
- For a radius larger than 9" refer to the Thermoforming Section on page 35.

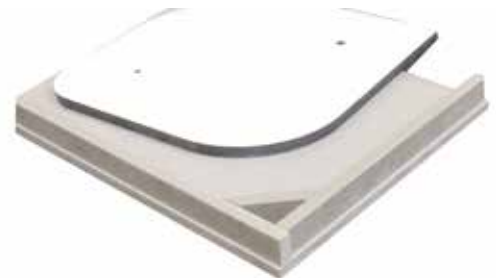

Figure 27C

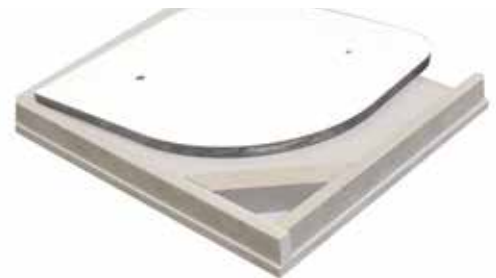

Figure 27D

Wilsonart® Solid Surface Sink Installation

- Inspect sink for imperfections and verify color.
- Identify location.
- Position sink using center-line dimensions. (FIG. 28A)

FAB TIP: Integral Wilsonart® Sinks may be mounted over a seam using the same techniques listed below. Integral in conventional or PT Seams. (FIG. 28B)

- Multiple bowl configurations are permitted; however, special reinforcement guidelines are required. (See Installation Section, page 37)
- Place wooden blocks with hot melt glue to position sink securely during glue up. (FIG. 28C)
- Rout hole in countertop directly under sink drain hole.

FAB TIP: Make sure hole is large enough for pipe clamp.

- Thoroughly clean areas to be seamed with denatured alcohol using a clean white shop rag.



Figure 28A



Figure 28B



Figure 28C



Wilsonart® Solid Surface Sink Installation Continued

- Apply ample amount Wilsonart® Hard Surface Adhesive to sink rim. (FIG. 29A)
- Clamp with pipe clamp through the drain hole. (FIG. 29B)

FAB TIP: Use spacers under clamp at sink flange and drain hole to prevent damage.

FAB TIP: Use clamp board (larger than the sink) under countertop to distribute clamping

- Check for seam kit squeeze-out around entire sink area. Remove pipe clamps after seam adhesive hardens.
- Rout sink opening(s) using:
 - Bowl flush trim bit (FIG. 29C)
 - Bowl profile bit (FIG. 29D)
 - See pages 10 & 11 for Tool Manufacturers
- Sand inside of sink for proper finish (See Finishing Section, page 36).

FAB TIP: WILSONART® SOLID SURFACE SINKS MUST BE SANDED TO PROVIDE CONSISTENT FINISH. FAILURE TO FINISH SINKS OFTEN LEADS TO CUSTOMER DISSATISFACTION.

- Wilsonart® Solid Surface vanity sinks are equipped with activated overflows. They are also available with non-overflow by special order.



Figure 29A



Figure 29B



Figure 29C



Figure 29D

General Cutout Requirements

These procedures are for cutouts that do not involve heat generating/producing appliances or items. See Cooktop Cutout requirements on page 31 for cutouts involving heat generating items installed in or over a cutout.

- Cutouts must be performed with a router only.
- 12" x 12" or larger cutouts must be left on job site for color match repair material.
- Secure cutouts to inside of sink base cabinet.
- Inside corners of all cutouts must be radiused.
 - Use 1/2" (9.5mm) or larger diameter bits.
 - See pages 31-32 for Cooktop Cutouts requirements.
- Round over top and bottom edges of cutouts a minimum 1/16" (1.5mm) radius.
- Remove any roughness, nicks and/or router "chatter" with 150-grit (80 micron) or finer sandpaper.
- Allow at least 1/8" (3mm) clearance space on all sides for drop-in sinks.
- Allow at least 1/16" (1.5mm) clearance space on all sides for outlets.
- Web supports required within 3" (76mm), but no closer than 1" (25mm) from the edge of the cutout.



Cooktop Cutouts

- Cutouts must be performed with a router only.
 - Adhere cutouts to inside of sink base cabinet.
- A minimum 1/4" (6.4mm) gap is required between edge of cutout and cooktop. (FIG. 31A)
- Inside corners of all cutouts must have a minimum radius of 1/4" (6.4mm). (FIG. 31C)
- Corners of cooktop cutouts must be reinforced with 5"x 5" (128.5mm x 128.5mm) 45° beveled Wilsonart® Solid Surface corner blocks. (FIG. 31B & 31C)
- Roundover top and bottom edges of cutout minimum 1/16" radius and ease all edges of reinforcing blocks.
- Sand sides of cooktop cutout to be free of roughness, nicks and router "chatter" with minimum 150-grit or finer sandpaper.

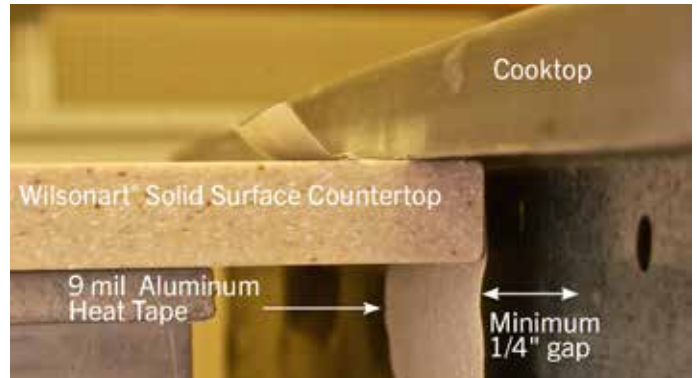

Figure 31A

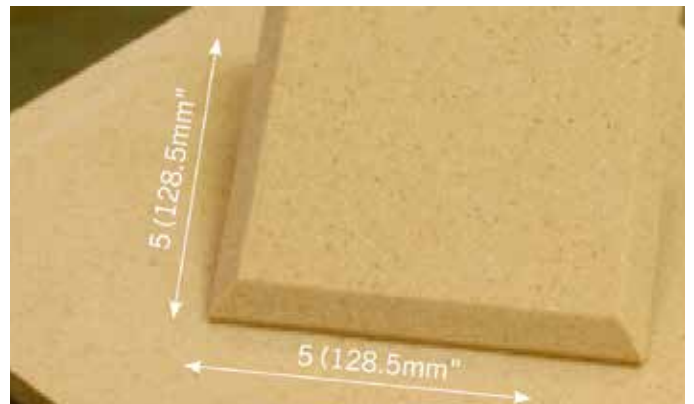

Figure 31B



Figure 31B

Cooktop Cutouts

- Wrap entire cooktop opening with 9 mil aluminum heat reflective tape.
- Place an additional layer of tape at all corners.
- Inform cooktop installer that tape must not be removed.
- Nomex® will assist with heat resistance.
- Do not fold tape under the bottom of the cutout. (FIG. 32A)
- Tape must extend past the edge of cooktop flange. Trim excess (FIG. 31A & 32A)
- Never fasten cooktop to Wilsonart® Solid Surface with mechanical fasteners.
 - Use a wood block between Wilsonart® Solid Surface and cooktop fasteners
- If minimum cutout dimension listed above cannot be met, follow requirements for cooktop mantle or stainless steel ring.



Figure 32A

Backsplash

- Use 100% silicone to adhere backsplash to countertop and wall.
- Apply continuous bead to bottom of backsplash (FIG. 33A)
- Dots of hot melt adhesive can be used to adhere backsplash to the wall while silicone cures.
- Remove excess silicone squeeze-out, leaving only a small inside corner bead. (FIG. 33B)
- On full height backsplash, apply all Wilsonart® Solid Surface fabrication guidelines. (FIG. 33C)
 - 1/4" (6.4mm) radiused inside corners
 - Space for expansion
 - Offset seams
 - Cutouts must be made with a router (FIG. 33C)
 - Attach backsplash with silicone. Do not hard seam to countertop.



Figure 33A



Figure 33B



Figure 33C

Cove Backsplash

- Cut Wilsonart® Solid Surface backsplash to desired height. (FIG.34A)
 - Allow 7/8" (11.3mm) for cove strip. (FIG. 34A)
- Cut a 7/8" (22.23mm) strip for coving. (FIG.33A) Bevel 7/8" (22.23mm) cove strip on a 45° angle. This will reduce router chatter.
- Cut 7/8" (22.23mm) x 1/8" (1.6mm) rebate into the Wilsonart® Solid Surface deck to accept cove strip. (FIG. 34A)
- Clean with denatured alcohol and clean white cloth.
- Adhere cove strip and backsplash to countertop with Wilsonart® Hard Surface adhesive
 - 100% coverage is required.
 - Backsplash squaring block (FIG. 34B)
- Ensure cove strip is tight against front edge of rebate and clamp with spring clamps and bar clamps
 - Squeeze-out is required the entire length of all seams.
- After adhesive has cured completely, rout cove strip. (FIG. 34C)
- Sand to desired finish

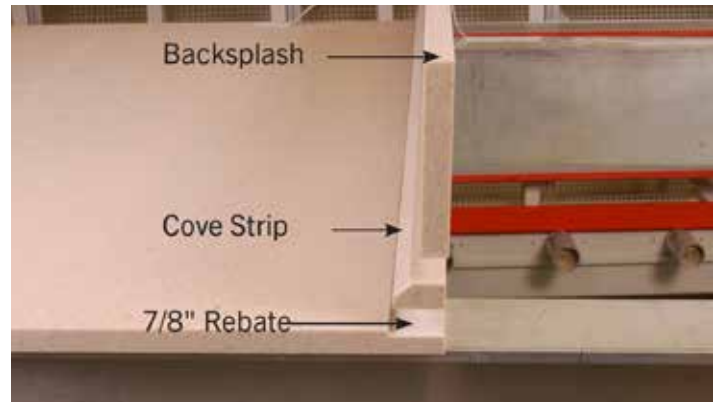

Figure 34A



Figure 34B



Figure 34C

Thermoforming

- See pages 42-44 for recommended Thermoforming colors.
- To thermoform Wilsonart® Solid Surface material, an oven that will heat the material is needed. (FIG. 35A)
- The sheet temperatures should be between 280° F to 325° F (137.8° C to 162.7° C) throughout the thickness during bending.

FAB TIP: Cold spots in the sheet will lead to cracks and whitening. Hot spots may cause blistering, discoloration, whitening and cracks.

- Wilsonart® Solid Surface material has a minimum bending radius of 3" (76.2mm).

FAB TIP: Bending sheets to a smaller radius can result in crazing, whitening, cracking, or reduction in impact resistance.

- For the best result, a set of male and female molds should be used to form the sheet into the desired radius shape (this is highly recommended for thermoforming 1/2" (13mm) sheets. (FIG. 35B)
- Heat Guns, Torches and Cal Rods will cause failure with Wilsonart® Solid Surface countertops.

FAB TIP: Spot heating or localized heating will cause problems due to the temperature difference between the heated area and the unheated area.(FIG. 35C)

Cool Down

- Allow the thermoformed sheet to cool down in the mold to less than 170° F (76.6° C) before removing from mold. Depending on the surrounding room temperature, cool down will take approximately 20 to 40 minutes.

Seaming

- All seaming must be done after cool down of thermoforming.
 - Squeeze out is required the entire length of all seams.



Figure 35A



Figure 35B



Figure 35C

Procedures

- Wipe all sanding dust from countertop surface between grit changes.
- Darker colors will require more attention to obtain the desired final finish.
- Be careful when selling dark colors and/or semi- gloss or gloss finishes. Inform your customer of the possible extra care necessary to maintain a dark color and/or finishes higher than a standard Matte or Satin finish.
- Use both horizontal and vertical strokes and overlapping your strokes by at least 50% for a consistent finish. (Fig. 36C)

Products

3M® Surfacing Abrasives – 1- 800-364-3577 There are 13 micron grades available. Micron grade 100 is the most coarse, is approximately equal to a grade 150, U.S. standard system. The .3 micron grade, one of the finest grades, is equivalent to a 10,000 grit.

Scotch-Brite® by 3M® – 1- 800-364-3577

3M's Scotch-Brite® Pad order of coarseness: 7447 Maroon (Fine), 7448 Grey (Very Fine) and 7445 White (Ultra Fine).

3M® Trizact™ Abrasives – 1-800-742-9546 or 1-800-364-3577 in the U.S.A. 651-737-6501 outside the U.S.A.

- The Trizact™ system, there is no need to finish the top with 3M® Scotch-Brite® pads and may decrease the amount of sanding steps.
- Backsplash squaring block (FIG. 35B)

Mirka Abralon Pads – 1-800-843-3904 Recommended for dark colors.

Sia -1-800-459-3534
www.sia-abrasives.com

Standards

U.S. standard system: 16 grit (coarsest) to 2,000 grit (finest).

- Trizact™: 60mx (coarsest) to 20,000mx (finest)
- Micron system: 100 micron (coarsest) to .3 micron (finest)
- Abralon: Medium (coarsest) to mirror fine (finest)



Figure 36A



Figure 36B



Figure 36C

Abrasives Sanding Steps “Quick Steps” to Final “Finish”

For final finishing use the following steps located in the Abrasive Cross Reference Chart below:

Finish Type	Grit Scotch Brite™	3M™ Micron Scotch Brite™	Trizact Film™	Mirka Abralon	Sia	Notes
Matte	180 220 7447	80u 60u 7447	268XA Green A35 268XA Blue A10/7447	N/A	1950 Siaspeed Grit: P180 1950 Siaspeed Grit: P280 6120 Siavlies Very Fine	Standard Finish Easy/Low Maintenance
Satin	180 220 280 7448	80u 60u 40u 7448	N/A	80u 60u Medium 360	1950 Siaspeed Grit: P180 1950 Siaspeed Grit: P360 * Additional step only used on dark surfaces 1950 Siaspeed Grit: P600 7940 Siaair Grit: K1000 (dry)	Slightly More Difficult Medium Maintenance
Semi Gloss	180 220 280 7445 7448	80u 60u 40u 7445 7448	268XA Green A35 268XA Blue A10 268XA Orange A5	80u 60u 40u Medium 360 Super Fine 1000	1950 Siaspeed Grit: P180 1950 Siaspeed Grit: P280 1950 Siaspeed Grit: P360 * Additional step only used on dark surfaces 1950 Siaspeed Grit: P600 7940 Siaair Grit: K1000 (dry) 7940 Siaair Grit: K3000 (dry) 7940 Siaair Grit: K4000 (dry) 7940 Siaair Grit: K1500 (wet) 6120 Siavlies Microfine Dry (wet)	Requires special customer instructions Requires Fabricator to refinish
Gloss	180 220 280 7448 7445 Buffer with Polishing Compound	80u 60u 40u 7445 7448 Buffer with Polishing Compound	268XA Green A35 268XA Blue A10 268XA Orange A5 568XA White CeO or Buffer with Polishing Compound	80u 60u 40u Medium 360 Super Fine 1000 Mirror Fine 4000		Recommended for vertical surfaces only Requires fabricator to refinish

The gloss finish is not recommended for high traffic areas. It requires a trained fabricator to maintain its finish. ** Use with Microhook Interface Pad

FAB TIP: WILSONART® SOLID SURFACE SINKS MUST BE SANDED TO PROVIDE CONSISTENT FINISH. FAILURE TO FINISH SINKS OFTEN LEADS TO CUSTOMER DISSATISFACTION.



Jobsite Preparation

- Install web supports as required.
 - 1/2" or 3/4" MDF or particle board recommended.
 - Place around perimeter of countertop and at each cabinet support.
- Webbing must be straight, flat and level after installation. If shims are used, they must be installed between the cabinet and the web frames, not directly under the countertop. (FIG. 38A)
- Do not install Wilsonart® Solid Surface over a solid substrate, except at overhangs and 45° seams. (See pages 21 & 39)

Solid substrate support is required for all 45° seams at inside corner area only, and must extend past the first cabinet support on both sides of inside corner.

- Supports required every 24".
 - 100% coverage is required.
 - Backsplash squaring block (FIG. 38B)
- Certain unsupported areas are in need of stronger frame material. These include inside corner cabinets, especially lazy susan, dishwasher openings, sink base fronts, desks and anywhere else that the cabinet is weaker than others. (FIG. 38B)
 - Squeeze-out is required the entire length of all seams.
- Place web supports at both sides of all cutouts. Place supports no closer than 1" (25.4mm) and no further than 3" (76.2mm) from sides of cutout.
 - See pages 40 & 41 for additional web support requirements.
- Multiple bowl installations require special reinforcement to provide adequate support..
 - Place web support along both sides of the bowl installation.
 - Place sink setters, solid wood, MDF or plywood supports between each bowl.
 - Supports must rest on cabinet base or be attached to cabinet base to alleviate flexing
- Free standing stoves must be set to a minimum of 1/16" higher than surface of countertop.



Figure 38A

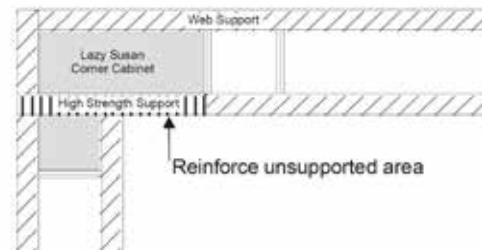

Figure 38B

Overhangs

- Additional support is required when the countertop overhangs the cabinet. (FIG. 39A) Refer to the following chart to determine support required:

Overhang	Support Required
0 - 6" (0-152.4mm)	None
6 - 12" (152.4mm-304.8mm) (FIG. 27A)	Brackets (corbels) (Under web frame support) <u>or</u> 3/4" plywood underlayment
12 - 18" (304.8mm-457.2mm) (FIG. 27B)	Brackets (corbels) (Under web frame support) <u>and</u> 3/4" plywood underlayment
18 - 24" (457.2mm-609.6mm)	Brackets (corbels) <u>and</u> 3/4" plywood underlayment <u>and</u> supporting legs

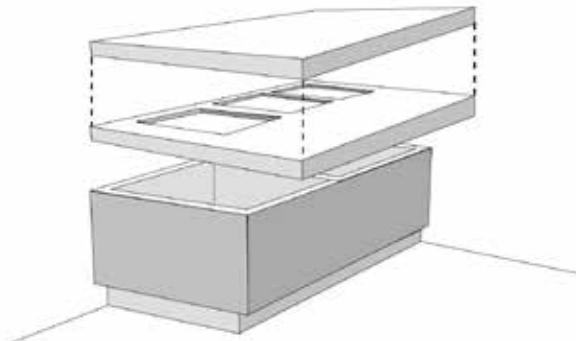

Figure 39A

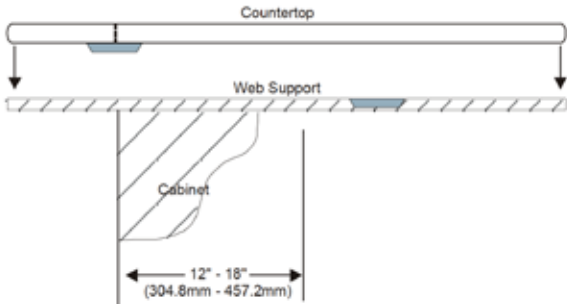

Figure 39B

- When brackets (corbels) are used, place them no more than 24" (609.6mm) apart. In addition, place brackets 12" (304.8mm) from open ends and against wall ends. (FIG. 39B & 39C)

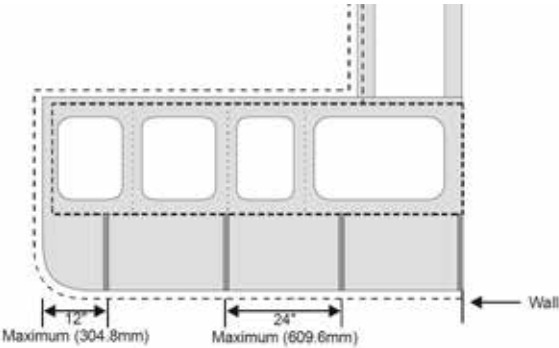

Figure 39C



Web Support Layout

Recommended web support material includes: Medium Density Fiberboard (MDF), plywood, hardboard etc.

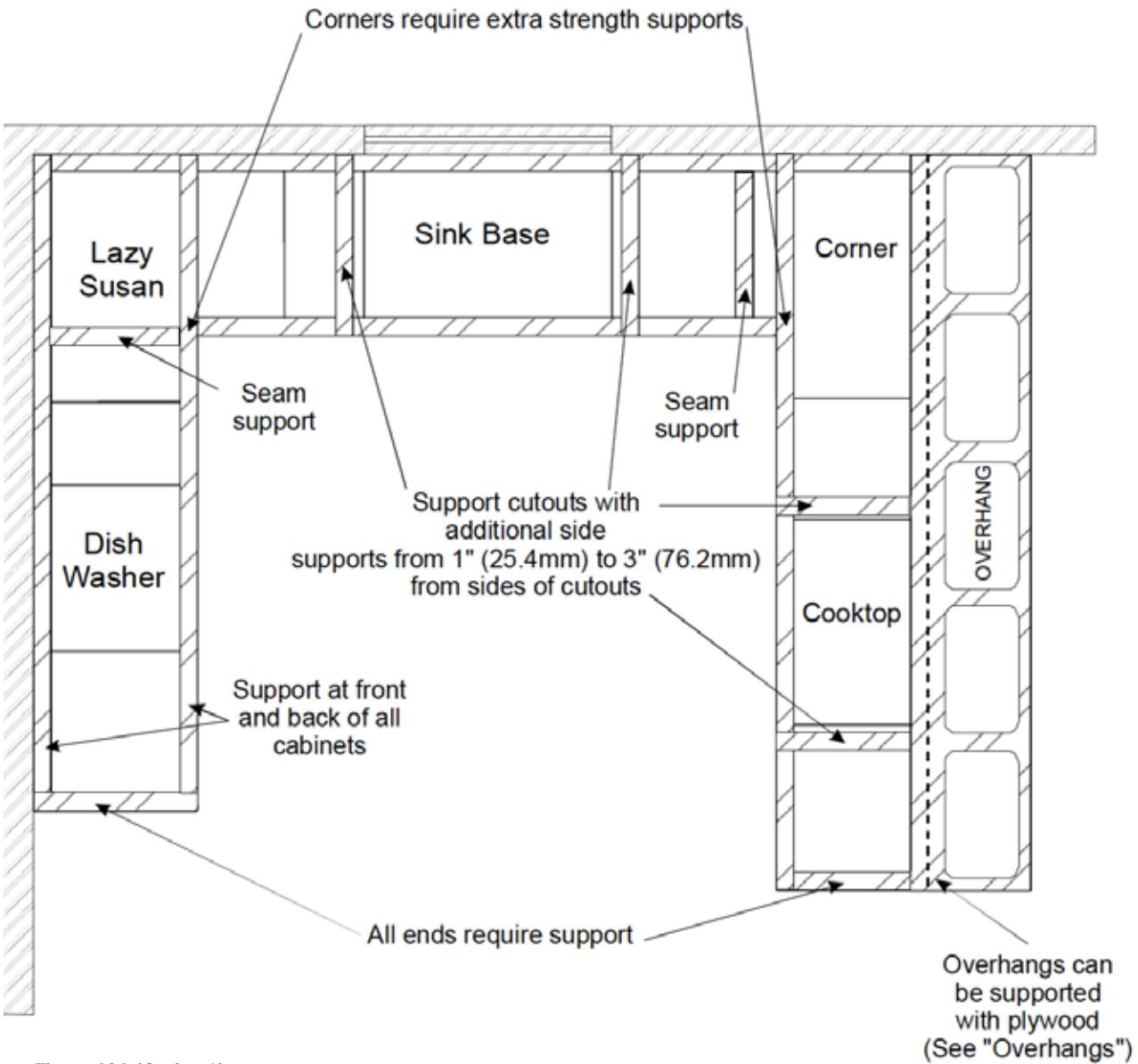

Figure 40A (Option 1)



Web Support Layout Continued

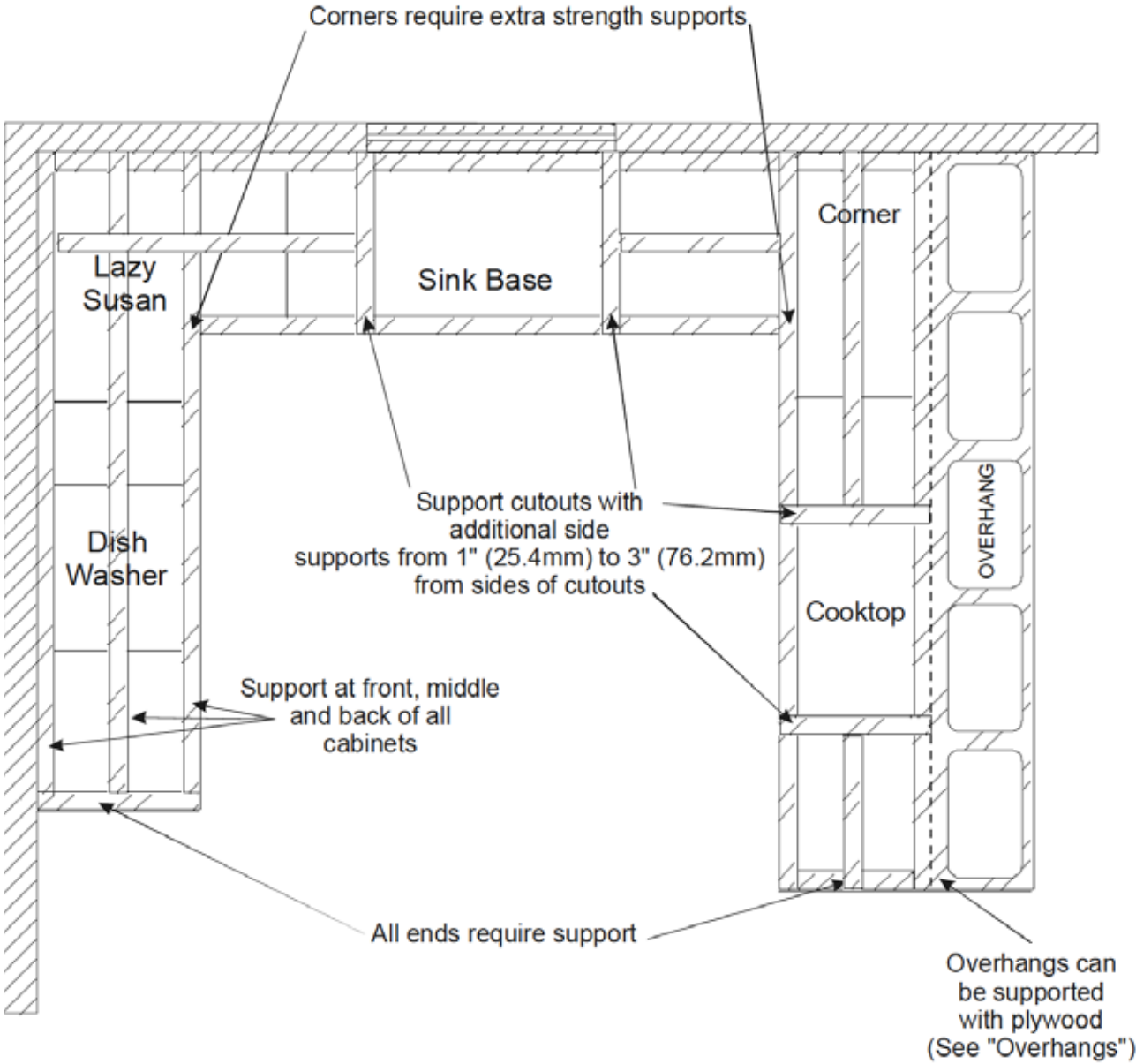

Figure 41A (Option 1)



RECOMMENDED FABRICATION TECHNIQUES

Pattern	Combined Name	Stacked	Vertical w/ Rebate	Miter-Fold Recommended	Thermo- formable
1530TM	Beige Tempest	✓	✓		✓
1531MG	Light Beige Mirage	✓	✓		✓
1572SL	Antique White	✓	✓		✓
1573MG	Frosty White Mirage	✓	✓		✓
1573SL	Frosty White	✓	✓		✓
9024ML	French Blue Melange	✓	✓		✓
9027ML	Indigo Melange	✓	✓		✓
9030ML	Baja Melange	✓	✓		✓
9033ML	Caramel Melange	✓	✓		✓
9036EA	Pebble		✓		✓
9040MG	Burnt Amber Mirage	✓	✓		✓
9041ML	Quarry Melange	✓	✓		✓
9043RS	Bluff Riverstone		✓		✓
9047ML	Chicory Cream Melange	✓	✓		✓
9070ML	Arctic Melange	✓	✓		✓
9074EA	Bluestone		✓		✓
9077ST	Milk Glass Spectra	✓	✓		✓
9091ML	Midnight Melange	✓	✓		✓
9092MG	Black Onyx Mirage	✓	✓		✓
9100GS	Coconut Oil	✓	✓		✓
9101GS	Oatmeal	✓	✓		✓
9104CS	Chipped Chocolate	✓	✓		
9105CS	Night Stars	✓	✓		
9106CS	Maple Harvest	✓	✓		
9107CS	Clouded		✓		
9108CS	Gold Glitz	✓	✓		
9109CS	Garnet Glitz	✓	✓		

RECOMMENDED FABRICATION TECHNIQUES

Pattern	Combined Name	Stacked	Vertical w/ Rebate	Miter-Fold Recommended	Thermo- formable
9110CS	Paris Fog	✓	✓		
9111MG	Chai Cream Mirage	✓	✓		✓
9115GS	Zen Grey	✓	✓		✓
9116GS	Soothing Grey	✓	✓		✓
9130MG	Marzipan Mirage	✓	✓		✓
9135MG	Cashmere Mirage	✓	✓		✓
9137RS	Blanco Riverstone	✓	✓		✓
9138RS	San Gabriel Riverstone		✓		✓
9144SN	Sonata Chocolate	✓	✓		✓
9175ML	Avalanche Melange	✓	✓		✓
9194TM	Steel Grey Tempest	✓	✓		✓
9195ML	Northern Melange	✓	✓		✓
9196RS	Yukon Riverstone	✓	✓		✓
9197RS	Sandy Riverstone	✓	✓		✓
9198EA	Whitewater		✓		✓



RECOMMENDED FABRICATION TECHNIQUES

Pattern	Combined Name	Stacked	Vertical w/ Rebate	Miter-Fold Recommended	Thermo- formable
9199MG	Pearl Mirage	✓	✓		✓
9200CS	Mystique	✓	✓		✓
9201GS	Hot Stone	✓	✓		✓
9202CS	Sea Stone		✓		
9203CE	Dusk Ice	✓	✓		
9204CE	Morning Ice	✓	✓		
9205CE	Champagne Ice	✓	✓		
9206CE	Desert Ice	✓	✓		
9207CS	Flint Rock	✓	✓		
9208CS	White Stone		✓		
9209CM	Moon Geyser		✓		
9210CM	Europa		✓		
9211CM	Jovian		✓		
9212CM	Triton		✓		
9213CM	Orion's Belt		✓		
9214CM	Asteroid		✓		
D354SL	Designer White	✓	✓		✓
D426MG	Raven Mirage	✓	✓		✓
D50TM	Khaki Brown Tempest	✓	✓		✓
9253CM	Arctic Dune		✓		
9215CE	Kimberlite	✓	✓		
9218CM	Grey Beola		✓		
9219GS	Brooklyn Concrete	✓	✓		✓
9220CE	Tumbled Stone		✓		



Pattern	Combined Name	Stacked	Vertical w/ Rebate	Miter-Fold Recommended	Thermo- formable
9229SS	Grey Moonstone	✓	✓	✓	✓
9230SS	Powder White	✓	✓	✓	✓
9232SS	Peace Grey	✓	✓	✓	
9233SS	Beachfront	✓	✓	✓	✓
9234SS	Golden Sail			✓	✓
9235SS	Classic Travertine		✓	✓	
9236SS	Beige Travertine			✓	✓
9237SS	Whisper White			✓	✓
9238SS	Iron Falls			✓	✓
9239SS	Gulfcoast			✓	✓

