

# C-107-4 HANGER FOR C-104 OR C-108 TRACK

## INSTRUCTION SHEET



### PARTS LIST

C-107-4 HANGER ASSEMBLED (2 PER DOOR)

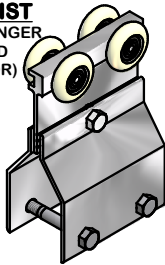

5/16" -18 X 2-1/2" HEX BOLT (2 PER HANGER)



5/16" PLAIN WASHER (2 PER HANGER)



5/16" HEX NUT (2 PER HANGER)



EXTRUDED ALUMINUM TRACK

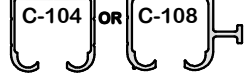

OR C-107-8 HANGER ASSEMBLED 7" WIDE (2 PER DOOR)

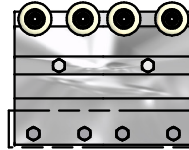

C-107-8 DETAIL "A"

### SPECIFICATIONS:

-LOAD CAPACITY:  
C-107-4 HANGERS:  
350 LBS PER DOOR  
C-107-8 HANGERS:  
600 LBS PER DOOR

-HEAVY-DUTY  
PRECISION BALL  
BEARING WHEELS  
WITH NYLON TIRE.

-CLAMP-TYPE FACE  
MOUNTING DESIGN.  
ADJUSTABLE FOR  
DOOR THICKNESS OF  
1-3/4" - 2-1/4".

-FOR BY-PASSING,  
BI-PARTING, POCKET,  
AND SURFACE  
MOUNT/BARN STYLE  
APPLICATIONS.

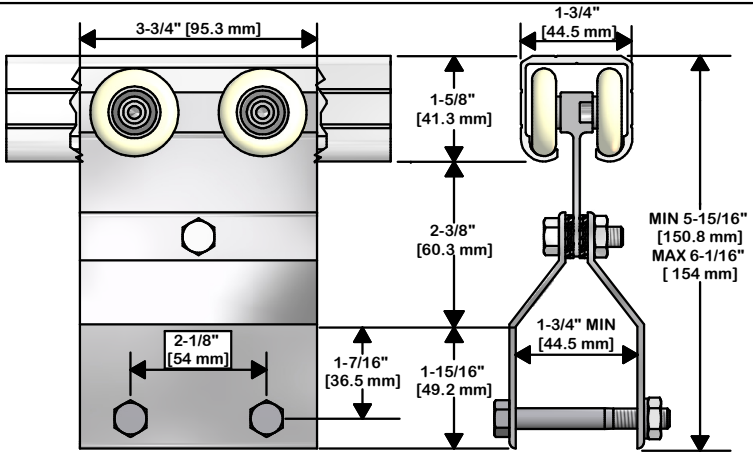

### STEP 1

DETERMINE DOOR SIZE/HEADER HEIGHT BASED ON DIMENSIONS SHOWN IN DETAIL VIEWS AND CLEARANCE REQUIRED BELOW DOOR.

### STEP 2

LOCATE AND DRILL 21/64"Ø HOLES FOR BOLTS USING THE DIMENSIONS SHOWN IN ILLUSTRATION. NOTE: IF USING CAS-2 DOOR STOP ADD 2" TO DIMENSION FROM EDGE OF DOOR.

### STEP 3

PREPARE DOOR FOR INSTALLATION OF OPTIONAL PRODUCTS IF PURCHASED SUCH AS GUIDE CHANNELS, CUP PULLS, DOOR LOCKS, ETC. INDIVIDUAL INSTRUCTIONS ARE PROVIDED WITH THE RESPECTIVE PRODUCT.

### STEP 4

PLACE HANGER ASSEMBLY ON DOOR AND SECURE CLAMPS TO DOOR WITH 5/16"-18 HEX BOLTS(2), 5/16" WASHERS(2), AND 5/16" HEX NUTS(2).

### STEP 5

PLACE DOOR AND HANGERS INTO C-104 OR C-108 TRACK AND SECURE TO HEADER. ALTERNATE: IF TRACK ENDS ARE NOT ACCESSIBLE AFTER MOUNTING: AFTER PREPARING DOOR FOR HANGERS, INSTALL HANGERS IN TRACK AND MOUNT TRACK. RAISE DOOR INTO POSITION BELOW HANGERS & BOLT THROUGH PREDRILLED HOLES.

### STEP 6

LOCK DOOR HEIGHT AND PLUMB WITH 1/2" WRENCH ON HEX NUT OF CENTER BOLT.

DETAIL "A" OF C-107-8 HANGER HOLE LOCATIONS

OVERALL HANGER WIDTH: 7"

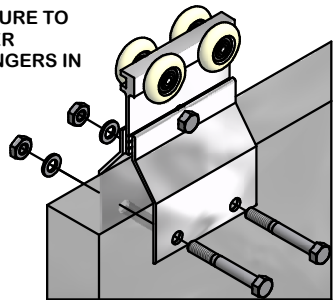
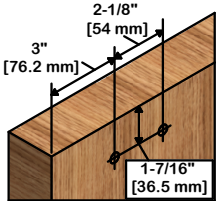
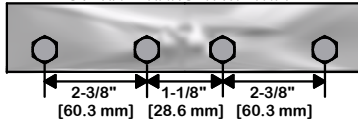

**crowdertrack**  
"Smooth as flight"

**K.N. CROWDER MFG. INC.**  
1220 BURLOAK DRIVE  
BURLINGTON, ONTARIO, CANADA, L7L 6B3  
TELEPHONE: 905-315-9788 - FAX: 905-315-8090  
TOLL FREE FAX: 1-800-567-0123

**K.N. CROWDER INC.**  
210 EIGHTH STREET SOUTH  
LEWISTON, NEW YORK, U.S.A. 14092  
TELEPHONE: 1-716-754-8247  
TOLL FREE FAX: 1-800-567-0123

WEBSITE: [www.kncrowder.com](http://www.kncrowder.com) -- E-MAIL: [customerservice@kncrowder.com](mailto:customerservice@kncrowder.com)