

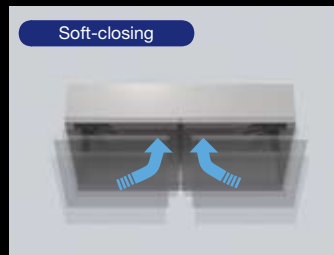

# MonoFlat LIN-X hinge™

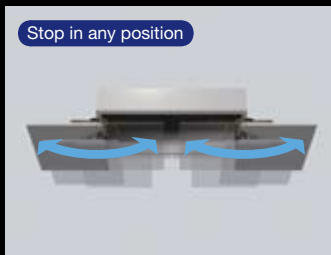

## MONOFLAT LIN-X HINGE PAT

## LIN-X450 / LIN-X600

| Item No.       | LIN-X450                             | LIN-X600                               |
|----------------|--------------------------------------|--|
| Door Width     | 400 ~ 500mm<br>(15-3/4" ~ 19-11/16") | 550 ~ 650mm<br>(21-21/32" ~ 25-19/32") |
| Door Height    | 600 ~ 2400mm (23-5/8" ~ 94-1/2")     |  |
| Door Thickness | 15~24mm (19/32" ~ 61/64")            |  |
| Door Weight    | *Max 17kg (37.4lbs)                  | *Max 24kg (52.8lbs)                    |

\*Max door weight will vary depending on number of hinges used.

- **Lateral Swing Mechanism**  
Allows doors to swing out laterally in a small radius, ideal for tight front space application.
- **Full Access to Cabinet**  
Door will not get in the way when fully opened providing full access to the cabinet.
- **Free Swing & Soft-close**
- **Easy Installation**  
Designed for standard 32 system mounting, with snap-on hinge.
- **4-Way Adjustable**  
3-way adjustable like concealed hinges and also with parallel adjustment.
- **Various Applications**  
Can be used in single or double door configuration. Ideal for cabinets in kitchen, bathroom, laundry room etc.  
\*For overlay use.

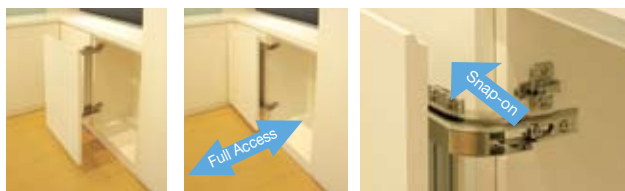

• Easy access full opening  
Ideal for wall / base cabinet, corner use etc.

• Easy installation

### Lateral Swing Mechanism

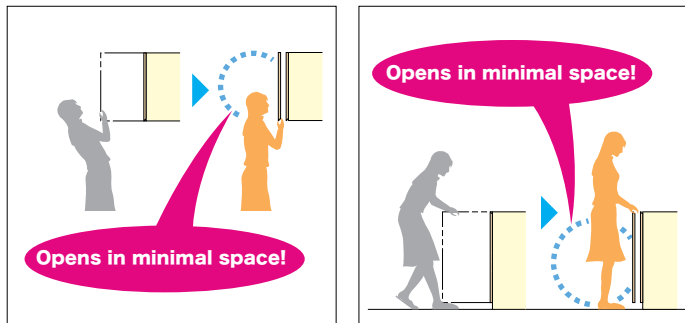

Ideal for tight front space application

### Can be Opened from Various Points

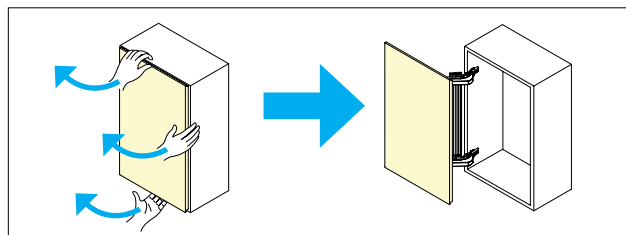

Please note handle position before installation.  
Handle may interfere with hinge.

### 4Way Adjustment

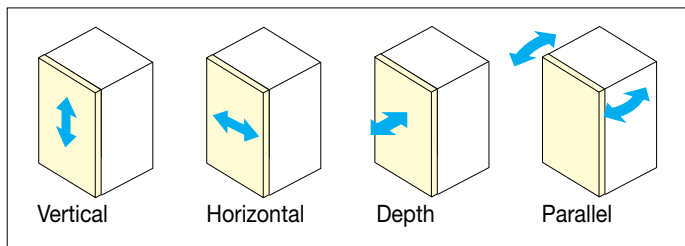

### Various Applications

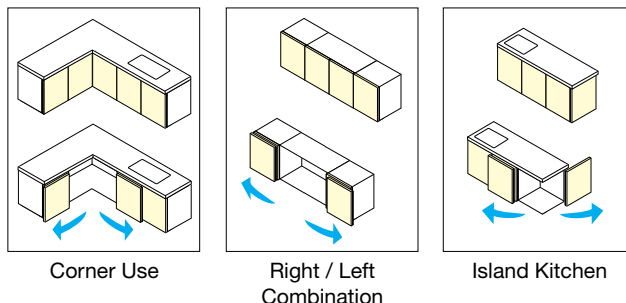

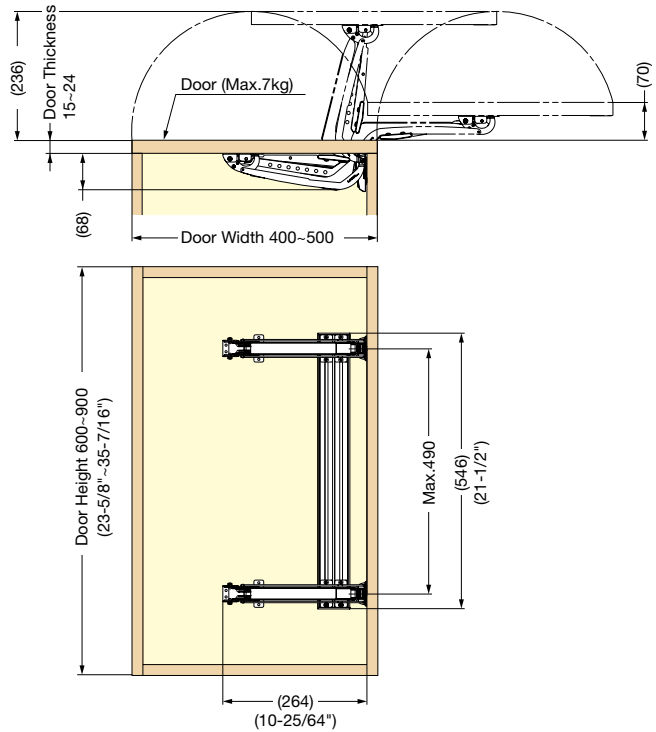
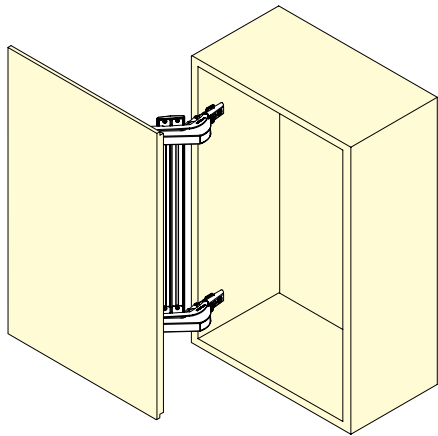

|                |                                   |
|----------------|-----------------------------------|
| Door Width     | 400 ~ 500mm (15-3/4" ~ 19-11/16") |
| Door Height    | 600 ~ 900mm (23-5/8" ~ 35-7/16")  |
| Door Thickness | 15 ~ 24mm (19/32" ~ 61/64")       |
| Door Weight    | Max. 7kg (15.4lbs) / Door         |

\*Can be used on heavier / taller doors by adding hinge arms.  
Please see page 12 for details.

| Item No.   | Overlay       | Material         | Finish            |
|------------|---------------|------------------|-------------------|
| LIN-X450   | 19mm (3/4")   | Steel / Aluminum | Nickel / Anodized |
| LIN-X450+5 | 14mm (35/64") |                  |                   |



- \*Parts included: •Hinge Body: 2pcs      •Connecting Bar: 1pc  
 •Mounting plate: 2pcs      •Cover Cap: 2pcs



# ■ LIN-X450 PAT Individual Parts for Tall / Heavy Doors

|                |                                   |
|----------------|-----------------------------------|
| Door Width     | 400 ~ 500mm (15-3/4" ~ 19-11/16") |
| Door Height    | 600 ~ 2400mm (23-5/8" ~ 94-1/2")  |
| Door Thickness | 15 ~ 24mm (19/32" ~ 61/64")       |
| Door Weight    | Max. 17kg (37.4lbs)               |

### Ordering Info

Use corresponding letter in below table, and see "Parts Breakdown Table" for parts to be ordered.

| Door Height                            | Door Weight  |                                  |                                 |                                   | Connecting Bar / Cover Cap           |
|--|--|----------------------------------|---------------------------------|-----------------------------------|--------------------------------------|
|  | ~ 15.5lbs<br>(~ 7.0kg)   | 15.6 ~ 23.0lbs<br>(7.1 ~ 10.5kg) | 23.1 ~ 31lbs<br>(10.6 ~ 14.0kg) | 31.1 ~ 37.4lbs<br>(14.1 ~ 17.0kg) |                                      |
| 23-5/8" ~ 35-7/16"<br>(600 ~ 900mm)    | LIN-X450<br>Standard Set<br>Connecting Bar<br>& Cover included | B                                |                                 |                                   | LIN-X450-L540 1pc<br>LIN-X450C 2pcs  |
| 35-7/16" ~ 47-1/4"<br>(901 ~ 1200mm)   | A  | B                                | C                               |                                   | LIN-X450-L840 1pc<br>LIN-X450C 2pcs  |
| 47-1/4" ~ 59-3/64"<br>(1201 ~ 1500mm)  | A  | B                                | C                               | D                                 | LIN-X450-L1140 1pc<br>LIN-X450C 2pcs |
| 59-3/64" ~ 70-7/8"<br>(1501 ~ 1800mm)  | B  | B                                | C                               | D                                 | LIN-X450-L1440 1pc<br>LIN-X450C 2pcs |
| 70-7/8" ~ 82-11/16"<br>(1801 ~ 2100mm) | B  | B                                | C                               | D                                 | LIN-X450-L1740 1pc<br>LIN-X450C 2pcs |
| 82-11/16" ~ 94-1/2"<br>(2101 ~ 2400mm) | C  | C                                | C                               | D                                 | LIN-X450-L2040 1pc<br>LIN-X450C 2pcs |

### Parts Breakdown Table

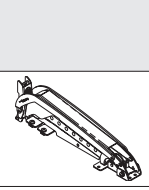
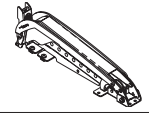
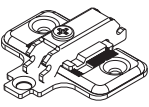
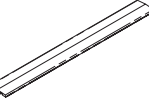
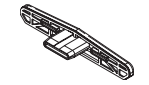
| Item Number  | Description                   |  | Qty Required    |   |   |   |
|--|-------------------------------|---|-----------------|---|---|---|
|  |                               |   | A               | B | C | D |
| LIN-X450ACD  | Single Arm ( with Damper )    |  | 2               | 3 | 3 | 3 |
| LIN-X450A  | Single Arm ( without Damper ) |   | -               | - | 1 | 2 |
| 230-P4W-32T<br>(for 19mm overlay)<br>or<br>230-P4W-32T+5<br>(for 14mm overlay) | Mounting Plate                |  | 2               | 3 | 4 | 5 |
| LIN-X450-L540  | Connecting Bar L=540MM        |  | See table above |   |   |   |
| LIN-X450-L840  | Connecting Bar L=840MM        |   |                 |   |   |   |
| LIN-X450-L1140   | Connecting Bar L=1140MM       |   |                 |   |   |   |
| LIN-X450-L1440   | Connecting Bar L=1440MM       |   |                 |   |   |   |
| LIN-X450-L1740   | Connecting Bar L=1740MM       |   |                 |   |   |   |
| LIN-X450-L2040   | Connecting Bar L=2040MM       |   |                 |   |   |   |
| LIN-X450C  | End Cap for Connecting Bar    |  | See table above |   |   |   |

**Example:** 36"H×18"W, 16lbs door. Item number and quantity required.

LIN-X450ACD      3pcs  
 230-P4W-32T      3pcs  
 LIN-X450-L840    1pcs  
 LIN-X450C        2pcs

■ Door Preparation

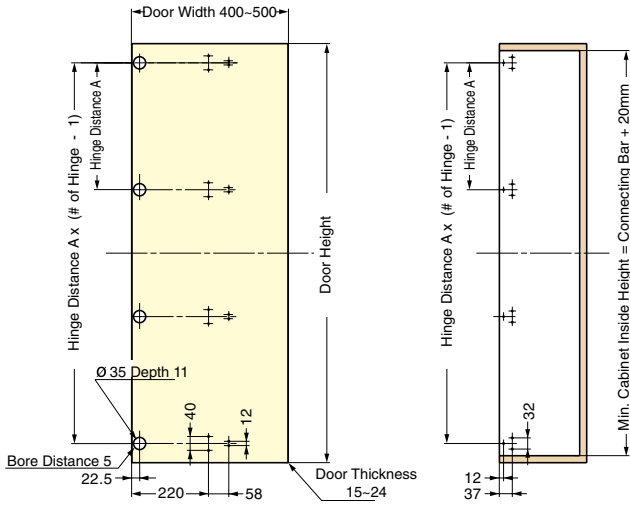

Hinge in middle should be positioned at or equally distributed from center of door.

■ Cabinet Preparation

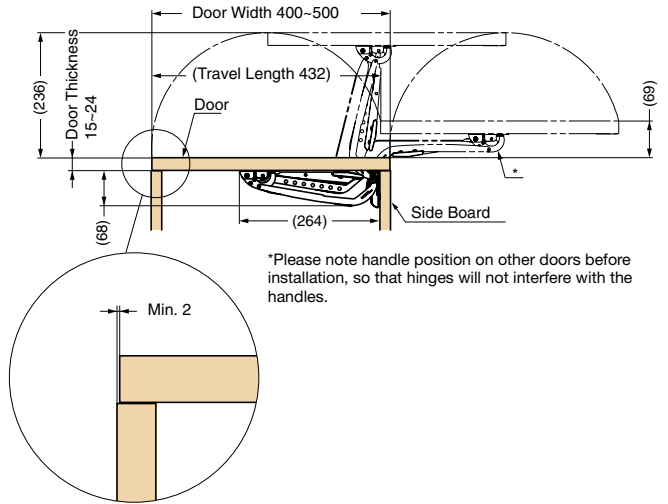

■ Hinge Distance A

| # of Hinges | Length of Connecting Bar (mm) |       |       |       |       |       |
|-------------|-------------------------------|-------|-------|-------|-------|-------|
|             | 540                           | 840   | 1140  | 1440  | 1740  | 2040  |
| 2 pcs       | 490                           | 790   | 1090  | -     | -     | -     |
| 3 pcs       | 245                           | 395   | 545   | 695   | 845   | -     |
| 4 pcs       | -                             | 263.3 | 363.3 | 463.3 | 563.3 | 663.3 |
| 5 pcs       | -                             | -     | 272.5 | 347.5 | 422.5 | 497.5 |

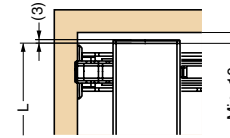

■ Hinge Arm

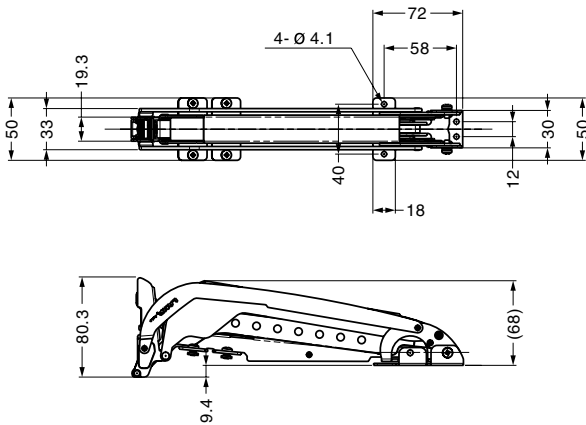

■ Mounting Plate (230-P4W-32T)

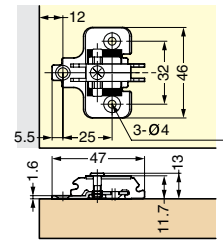

■ Connecting Bar

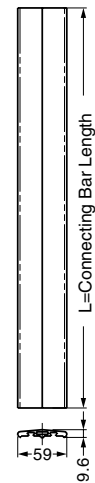

■ Cup Cover

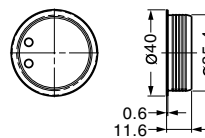

■ Bar End Cap

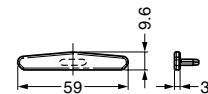

# MONOFLAT LIN-X 600

MONOFLAT LIN-X

In case of using 4 hinge arms.

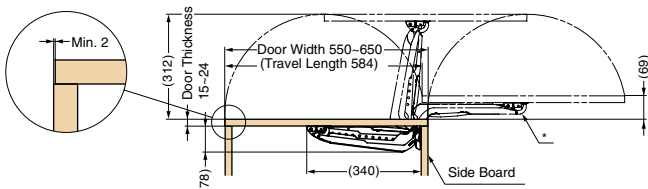
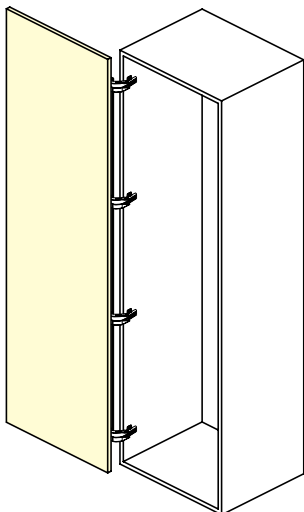

Please note handle position on other doors before installation, so that hinges will not interfere with the handles.

|                |                                     |
|----------------|-------------------------------------|
| Door Width     | 550 ~ 650mm (21-21/32" ~ 25-19/32") |
| Door Height    | 600 ~ 2400mm (23-5/8" ~ 94-1/2")    |
| Door Thickness | 15 ~ 24mm (19/32 ~ 61/64")          |
| Door Weight    | MAX. 24kg (52.8lbs)                 |

\*Max door weight will vary depending on number of hinges used.

- **Lateral Swing Mechanism**  
Allows doors to swing out laterally in a small radius, ideal for tight front space application.
- **Full Access to Cabinet**  
Door will not get in the way when fully opened providing full access to the cabinet.
- **Free Swing & Soft-close**
- **Easy Installation**  
Designed for standard 32 system mounting, with snap-on hinge.
- **4-Way Adjustable**  
3-way adjustable like concealed hinges and also with parallel adjustment.
- **Various Applications**  
Can be used in single or double door configuration. Ideal for cabinets in kitchen, bathroom, laundry room etc.  
\*For overlay use.

## LIN-X600 PAT Basic Standard Kit

|                |                                     |
|----------------|-------------------------------------|
| Door Width     | 550 ~ 650mm (21-21/32" ~ 25-19/32") |
| Door Height    | 600 ~ 900mm (23-5/8" ~ 35-7/16")    |
| Door Thickness | 15 ~ 24mm (19/32 ~ 61/64")          |
| Door Weight    | MAX. 9kg (19.8lbs)                  |

| Item No. | Overlay     | Material        | Finish           |
|----------|-------------|-----------------|------------------|
| LIN-X600 | 19mm (3/4") | Steel, Aluminum | Nickel, Anodized |

Included Parts: 2 each of Hinge Arms, Mounting Plates, Cup Covers, Bar End Caps and 1 Connecting Bar.

### ■ Hinge Arm

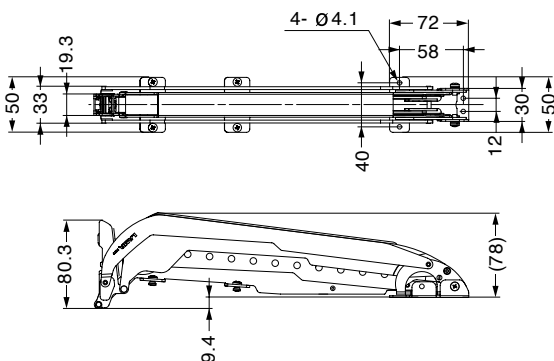

### ■ Mounting Plate (230-P4W-32T)

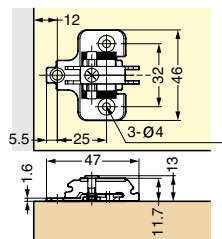

### ■ Connecting Bar

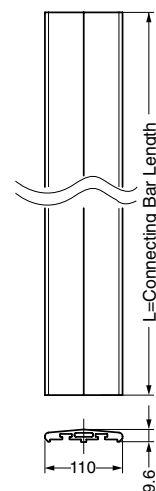

### ■ Cup Cover

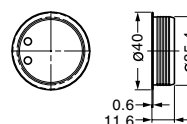

### ■ Bar End Cap

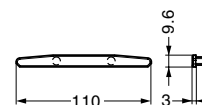

# LIN-X600 PAT Individual Parts for Tall / Heavy Doors

|                |                                     |
|----------------|-------------------------------------|
| Door Width     | 550 ~ 650mm (21-21/32" ~ 25-19/32") |
| Door Height    | 600 ~ 2400mm (23-5/8" ~ 94-1/2")    |
| Door Thickness | 15 ~ 24mm (19/32" ~ 61/64")         |
| Door Weight    | Max. 24kg (52.8lbs)                 |

### Ordering Info

Use corresponding letter in below table, and see "Parts Breakdown Table" for parts to be ordered.

| Door Height                         | Door Weight   |                               |                                |                                |                                | Connecting Bar / Cover Cap         |
|-------------------------------------|---|-------------------------------|--------------------------------|--------------------------------|--------------------------------|------------------------------------|
|                                     | ~ 19.9lbs (~ 9.0kg)                                   | 20.0 ~ 26.5lbs (9.1 ~ 12.0kg) | 26.6 ~ 35.4lbs (12.1 ~ 16.0kg) | 35.5 ~ 44.2lbs (16.1 ~ 20.0kg) | 44.3 ~ 52.8lbs (20.1 ~ 24.0kg) |                                    |
| 23-5/8" ~ 35-7/16" (600 ~ 900mm)    | LIN-X600 Standard Set Connecting Bar & Cover included | B                             |                                |                                |                                | LIN-X60-L540 1pc<br>LIN-X60C 2pcs  |
| 35-7/16" ~ 47-1/4" (901 ~ 1200mm)   |   | B                             | B                              |                                |                                | LIN-X60-L840 1pc<br>LIN-X60C 2pcs  |
| 47-1/4" ~ 59-3/64" (1201 ~ 1500mm)  |   | B                             | B                              | C                              |                                | LIN-X60-L1140 1pc<br>LIN-X60C 2pcs |
| 59-3/64" ~ 70-7/8" (1501 ~ 1800mm)  |   | B                             | B                              | C                              | D                              | LIN-X60-L1140 1pc<br>LIN-X60C 2pcs |
| 70-7/8" ~ 82-11/16" (1801 ~ 2100mm) |   | B                             | B                              | C                              | D                              | LIN-X60-L1740 1pc<br>LIN-X60C 2pcs |
| 82-11/16" ~ 94-1/2" (2101 ~ 2400mm) |   |                               | C                              | C                              | D                              | LIN-X60-L2040 1pc<br>LIN-X60C 2pcs |

### Parts Breakdown Table

| Item Number                    | Description                   | Image | Qty Required    |   |   |   |
|--------------------------------|-------------------------------|-------|-----------------|---|---|---|
|                                |                               |       | A               | B | C | D |
| LIN-X600ACD                    | Single Arm ( with Damper )    |       | 2               | 3 | 3 | 3 |
| LIN-X600A                      | Single Arm ( without Damper ) |       | -               | - | 1 | 2 |
| 230-P4W-32T (for 19mm overlay) | Mounting Plate                |       | 2               | 3 | 4 | 5 |
| LIN-X60-L540                   | Connecting Bar L=540MM        |       | See table above |   |   |   |
| LIN-X60-L840                   | Connecting Bar L=840MM        |       |                 |   |   |   |
| LIN-X60-L1140                  | Connecting Bar L=1140MM       |       |                 |   |   |   |
| LIN-X60-L1440                  | Connecting Bar L=1440MM       |       |                 |   |   |   |
| LIN-X60-L1740                  | Connecting Bar L=1740MM       |       |                 |   |   |   |
| LIN-X60-L2040                  | Connecting Bar L=2040MM       |       |                 |   |   |   |
| LIN-X60C                       | End Cap for Connecting Bar    |       | See table above |   |   |   |

### Door Preparation

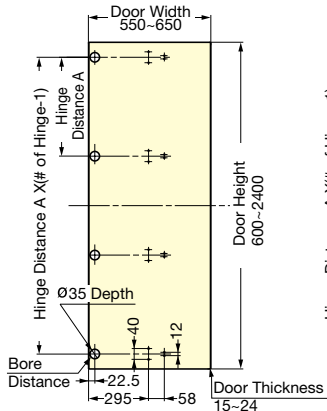

### Cabinet Preparation

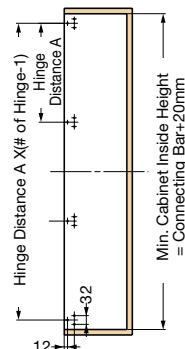

### Hinge Distance A

| # of Hinges | Length of Connecting Bar (mm) |     |       |       |       |       |
|-------------|-------------------------------|-----|-------|-------|-------|-------|
|             | 540                           | 840 | 1140  | 1440  | 1740  | 2040  |
| 2 pcs       | 490                           | 790 | -     | -     | -     | -     |
| 3 pcs       | 245                           | 395 | 545   | 695   | 845   | -     |
| 4 pcs       | -                             | -   | 363.3 | 463.3 | 563.3 | 663.3 |
| 5 pcs       | -                             | -   | -     | 347.5 | 422.5 | 497.5 |