

Ideal solution suspended cabinets

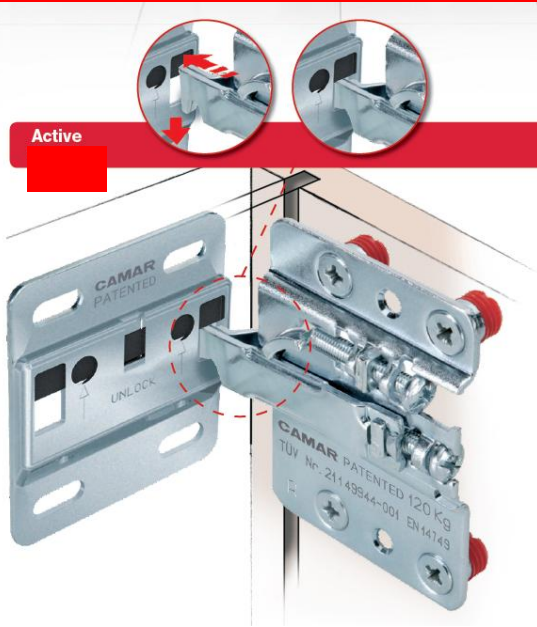

How can such a small bracket be able to support such a heavy load? Thanks to advanced technology, the result of our forty years' experience in researching solutions, the new 807 bracket possesses absolutely unique technical features: made totally in metal, it has a thickness of only 10mm, and offers an adjustment range of 19mm in the horizontal and 22mm in the vertical. Very easy to fit, through 4 small holes in the cabinet, it has a hooking system which prevents the cabinet from accidental falling from the wall. With Richelieu, your projects have more weight.



Product features

- **Multi-applications:** kitchen cabinets, bathroom vanities, living room furniture pieces. This product can be used for furniture pieces in all the rooms of your house.
- **Strong:** weight capacity up to 120kg (265lbs) per fitting.
- **Safety :** hook in system preventing from disconnection.
- **Adjustment:** horizontal 19mm (3/4") and vertical 22mm (7/8").
- **Trendy :** minimalisme trend.
- Patented and tested product.
- For a complete system, order:
 - support #807022G (pair)
 - cover caps #8070030(pair)
 - 2 mounting plates #897122G

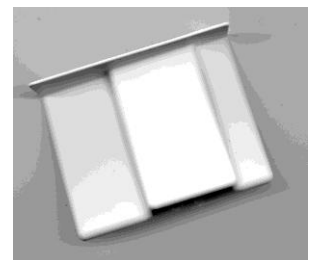

White cover cap

Product code	Description
807022G	Suspension bracket zinc (pair)
8070030	White cover cap (pair)
897122G	Mounting plate zinc(unit)

Technical informations

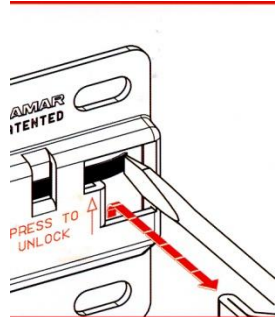
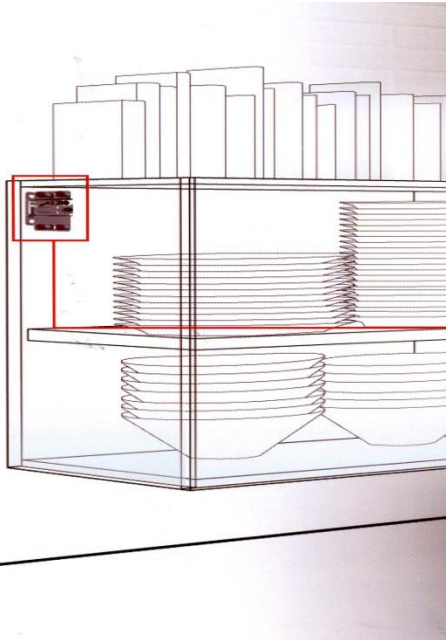

To unlock,
screwdriver required

897122G

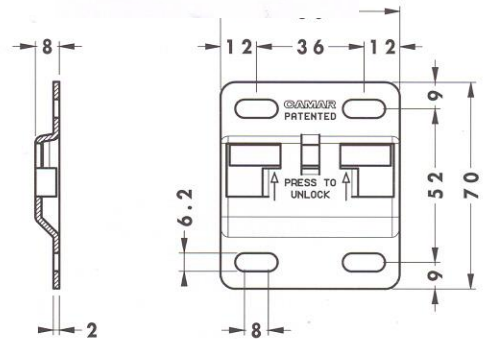

807022G

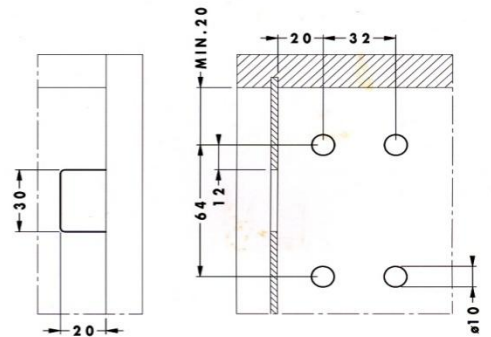
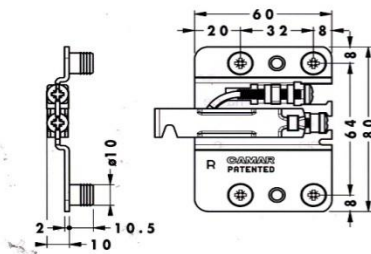

10mm dowels installation

