

Sliding hardware systems for stackable wood and glass partition walls and furniture fronts

HAWA-Aperto



HAWA-Aperto: Maximum functionality with minimum space requirements

Whether for partition walls or privacy screens, media walls or furniture fronts, for indoor or outdoor use – HAWA-Aperto is always the right solution. This sophisticated sliding hardware system will really bring your wood partition walls, glass doors and cabinet fronts into motion. High-quality models available:

HAWA-Aperto 60/H

Room partitioning is made easy with this economical hardware system for sliding wood walls with a door weight of up to 60 kg.

HAWA-Aperto 60/GL

This innovative hardware system for sliding glass walls with a door weight of up to 60 kg allows you to create light and airy privacy screens and room partitions.

HAWA-Aperto 40/F

You can stack flush cabinet fronts or media walls with a door weight of up to 40 kg with this highly successful furniture hardware system.

Hawa AG: a seal of approval for every product

Hawa AG has been synonymous with first class processing, precision manufacturing and high quality since its foundation more than 40 years ago. And we still bank on Switzerland as our one and only production location. Not least because of the fact that our business philosophy is based on typical Swiss values such as safety, precision, durability and quality service.

The sliding hardware system for lightweight stackable sliding wood walls

HAWA-Aperto 60/H

About the product

From individual interior design in private living areas to flexible space utilisation in shops and offices: HAWA-Aperto 60/H hardware enables you to partition rooms without the need for complicated systems with large dimensions and a corresponding price tag. You can join up to 9 wooden doors to form a light and quiet flush sliding wall with this innovative system. And you stack them away again in no time at all – either in parallel or at a 90° angle, depending on the space situation. The high degree of convenience offered by this cleverly designed sliding hardware is also noticeable elsewhere thanks to simplicity of design, ease of assembly and excellent running properties.



Elegant curve technology: the stacking area.

At a glance

- For lightweight sliding wood walls with doors of up to 60 kg, stackable in parallel or at an angle of 90°.
- High flexibility thanks to modular pluggable track system.
- Runs smoothly and quietly, doors close flush.
- The pivot door locks the entire front.
- Systems with low operational demands are also available without floor guides.
- Massive reduction in installation dimensions in comparison with conventional sliding wall systems.
- Suspension units can be inserted and fastened from the front face of the doors.

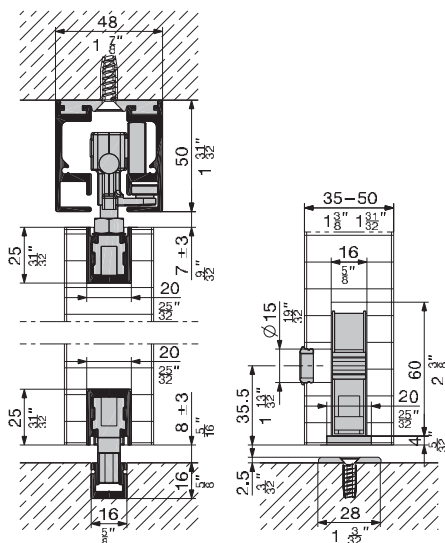

Floor guides can be omitted depending on operational demands.

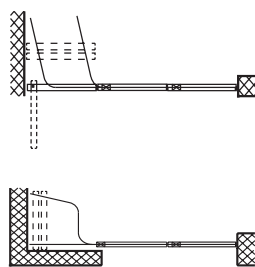

Stacking either parallel or at 90° to the direction of travel. Elegantly parked either way.

Technical specifications

Max. door weight	60 kg
Door thickness	35–50 mm
Min. door width	550 mm
Max. door width	
90° stacking	950 mm
Parallel stacking	1500 mm
Max. door height	2600 mm

The sliding hardware system for elegant stackable sliding glass walls

HAWA-Aperto 60/GL

About the product

From classic privacy screens in living areas to complex interior shop designs: the outlook for screens and partitions made of glass is bright with HAWA-Aperto 60/GL. This hardware makes it just as easy to move flush-front sliding glass walls with up to 9 doors as it is to park them using only a minimum of space. This is a system that convinces from beginning to end. The massively reduced installation dimensions of the filigree glass retainer profile the elegance of the construction material shine through. And the sophisticated glass mounting technology disappears behind covers that suit any architectural style. The flexibility and ease of installation are further seminal characteristics of the HAWA-Aperto 60/GL system – not least thanks to a unique building block system with pluggable anodised tracks and guides.

At a glance

- For elegant stackable sliding glass walls with doors of up to 60 kg, stackable in parallel or at an angle of 90°.
- Filigree glass retainer profile and aesthetic covers which can be fitted retrospectively.
- Outdoor use made possible by corrosion-resistant materials.
- Additional components available for stationary glass.
- Patented dry glazing for efficient and safe glass fastening.
- Light, smooth running.
- The surface area is flush when closed.



Top track aesthetically integrated in the ceiling with parking area cover.

Technical specifications

Max. door weight	60 kg
Glass thickness TSG	8/10 mm
Min. door width	500 mm
Max. door width parallel	
Sliding door	1100 mm
Pivot door	1200 mm
Max. door widths 90°	
Sliding and pivot door	950 mm
Max. door height	2600 mm

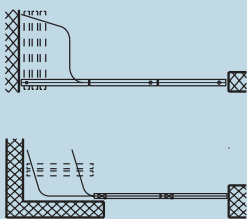

Stacking at 90° or parallel to the sliding axis.

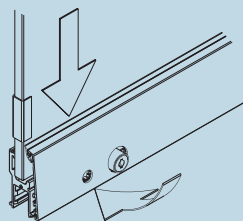

Clip-on covers available with various surface finishes.

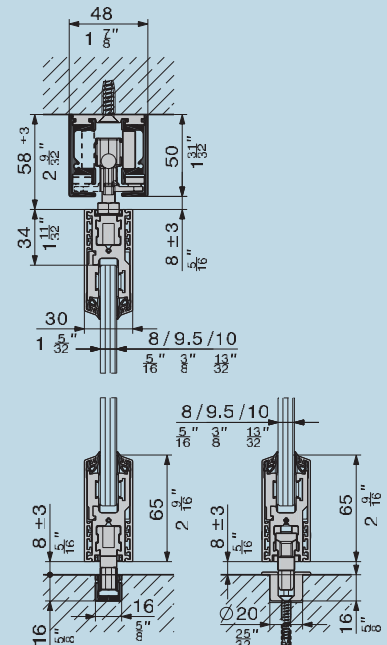

Designs without floor guides are also possible.

The hardware system for stackable, flush cabinet fronts and media walls

HAWA-Aperto 40/F

About the product

From office cabinets to hospital furniture: any application with a frequently opened front will be better off with HAWA-Aperto 40/F. It stacks up to 7 cabinet fronts elegantly to one side and prevents pivot or folding doors from jutting into the room. Leaving you with more space. And more room for manoeuvre during installation: you can build left-hand or right-hand systems, select the door width of your choice and design applications with a cabinet front that is always flush – even in combination with pivot doors on upper or lower cabinet units. All it takes are just three holes in the doors and a groove in the furniture base for the guide.

Technical specifications

Max. door weight	40 kg
Door thickness	19–25 mm
Max. door height	2600 mm
Max. door width	900 mm



Flush cabinet fronts:
Locking the pivot door also
locks the entire front.

At a glance

- Stacks up to 7 cabinet doors of up to 40 kg in the space-saving parking area.
- Doors do not jut into the room when open.
- Free access over the entire cabinet width.
- The entire front can be locked with just one pivot door.
- Furniture design is simple as no additional covers or work are required.
- Flush-front designs.

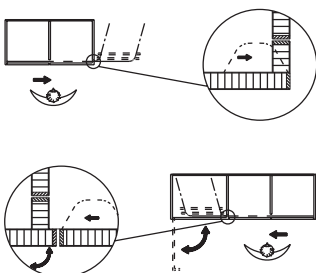

Stacking doors: hidden away or in the open as a design element.



Up to 7 doors disappear, neatly stacked.

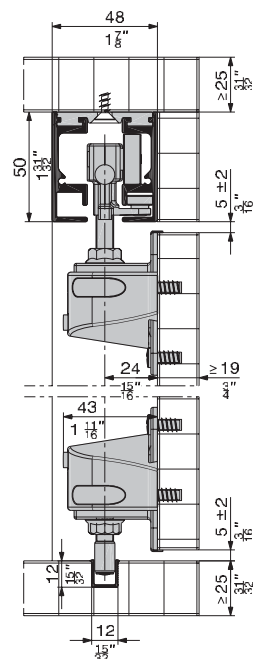

Simple cabinet design –
efficient production.

Also for very special design ideas

HAWA-Aperto individual

Open for anything

In our opinion, first-class hardware such as HAWA-Aperto should adapt to your ideas as far as possible – and not the other way around. For this reason we will be pleased to assist you with special solutions such as conservatory installations, stackable sliding shutters, additional door elements or other creative applications. And we won't stop at curved or cornered applications with directional changes. Just talk to us. You will soon see that we are nearly as flexible as our hardware systems.

Open for you

For any requests, questions and information concerning HAWA-Aperto: contact us.



HAWA-Aperto 60/GL
Special solution for a conservatory.



HAWA-Aperto 60/H
Special solution for stackable sliding shutters.

Available from specialist dealers

Further information:

Hawa AG
CH-8932 Mettmenstetten
Switzerland
Tel. +41 44 767 91 91
Fax +41 44 767 91 78
www.hawa.ch

